

2.BASIM

2020

U-PVC | UH-PVC | PP

ÜRÜN KATALOGU

PRODUCT CATALOGUE

FİYAT LİSTESİ / PRICE LIST



**PİMTAS**®

PLASTİK İNŞ. MALZ.SAN. VE TİC. A.Ş.

*Where you are,  
pimtas is there...*

BORU - EK PARÇA - VANA | PIPE - FITTING - VALVE



## DEĞERLİ MÜŞTERİMİZ

PİMTAŞ A.Ş. 1977 yılında kurulmuş olup, üretime başladığı andan itibaren plastik inşaat malzemelerinin (Boru, Ek parça, Küresel Vana, Kelebek Vana, Çekvalf, Rakor, Havuz ve Tesisat teknik ekipmanları) kendine özgü tasarımını ve imalatını yapan, plastik sektöründeki uluslar arası öncü kuruluşlardan biridir.

Bugün Pimtaş Plastik , ISO 9001 kalite yönetim sistemine ve TSE belgesine sahip olarak en yeni teknolojik altyapı, makine ve kalıp sistemleri ile başta Avrupa ülkeleri başta olmak üzere 105 ayrı ülkeye ihracat yapan ve 81 ilde tüketicinin memnuniyetini ve güvenini kazanmış bir firmadır.

Firmamıza ait üç ayrı üretim tesisi, Gebze Plastikçiler Organize Sanayi bölgesinde diğeri Gebze E5 Eskihisar sapağında bulunmaktadır. Toplam 50000 m2 kapalı 22000 m2 açık alana sahiptir.350'yi aşkın tecrübeli çalışanı ile 7/24 hizmet vermektedir.1977 yılından beri siz değerli müşterilerimize daha kaliteli ürünler ve hizmetler sunabilmek için üretiyor ve her geçen yıl kendimizi yeniliyoruz.

### Misyon

Güçlü bilgi birikimimizi, şirketimizin temel değerlerinden ödün vermeden teknoloji ile birleştirerek, ürün ve hizmetimizle fark yaratmak.

### Vizyon

Pimtaş Markasını tüm dünyada bilinir hale getirmek için gelişen teknolojiye paralel olarak, yenilikçi, mantıklı, ilkelerimiz ve sorumlu yaklaşımımızla, yüksek standartta ve kaliteli hizmet sunarak müşteri memnuniyetini en üst düzeye çıkartmak.



## OUR VALUED CUSTOMER

Pimtaş Plastik A.Ş. company was established in 1977 and within these years has become one of the leading international companies, having the ability of making own design and production in the sector of plastic building materials, such as plastic pipes, ball valves, butterfly valves, non-return valves, unions and swimming pool materials and equipments.

Having a production class in accordance with the European Norm EN 1452 and ISO 9001 Quality Assurance Certificate. Today, Pimtaş Plastik exports to 105 countries all over the globe, mostly to Europe, using the most modern technical know-how equipments and moulding machines.

Having been producing since 1977 we grow year by year and improve ourselves just to get the appreciation of our customers.

### **Mission**

We combine our strong accumulated knowledge with modern Technologies without sacrificing our basic values of our company; we try to make our products and services unique and develop our image and market sharing.

### **Vision**

Bringing the PIMTAŞ up to world-known and recognized all over the globe landmark, by using innovative, rational and principal approaches, we aim ourselves to come to higher level, to work for customers appreciation and to maintain our "Market Leadership", by selling 60% of the existing production capacity to foreign markets, - while doing this to fulfill our responsibilities towards humanity, environment and towards universal values.





# İÇİNDEKİLER / CONTENTS



02-03

**HAKKIMIZDA / ABOUT US**

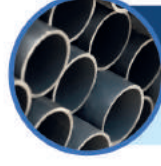

07-32

**U-PVC BORULAR / PIPES**

**İSKONTO / DISCOUNT : % .....**



33-38

**TEKNİK MALZEMELER  
TECHNICAL MATERIALS**

**İSKONTO / DISCOUNT : % .....**



39-56

**UH-PVC EK PARÇALAR / FITTINGS**

**İSKONTO / DISCOUNT : % .....**



57-58

**U-PVC PRİZ KOLYE  
CLAMP SADDLE**

**İSKONTO / DISCOUNT : % .....**



59-64

**UH-PVC RAKOR / UNION**

**İSKONTO / DISCOUNT : % .....**



65-76

**U-PVC KÜRESEL VANA  
BALL VALVES**

**İSKONTO / DISCOUNT : % .....**



77-88

**U-PVC AKTÜATÖRLÜ KÜRESEL VANA  
AKTUATOR BALL VALVES**

**İSKONTO / DISCOUNT : % .....**



89-98

**U-PVC ÇEKVALFLER / CHECKVALVES**

**İSKONTO / DISCOUNT : % .....**



99-104

**U-PVC KELEBEK VANA  
BUTTERFLY VALVES**

**İSKONTO / DISCOUNT : % .....**



105-120

**U-PVC AKTÜATÖRLÜ KELEBEK VANA  
AKTUATOR BUTTERFLY VALVES**

**İSKONTO / DISCOUNT : % .....**



121-150

**PP**

**İSKONTO / DISCOUNT : % .....**



151-156

**CONTALI EK PARÇALAR  
GASKET SOCKETED FITTINGS**

**İSKONTO / DISCOUNT : % .....**

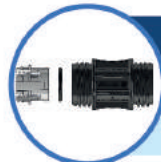

157-169

**YEDEK PARÇALAR  
SPARE PARTS**

**İSKONTO / DISCOUNT : % .....**





**U-PVC**  
**BORULAR / PIPES**

**ÜRETİM STANDARDI / PRODUCTION STANDARD**

**EN 1452-2**

**ÇAP / SIZE Ø20 - Ø400**

**U-PVC Yapıştırma Mufllu Borular**  
U-PVC Solvent Cement Socketed Pressure Pipes

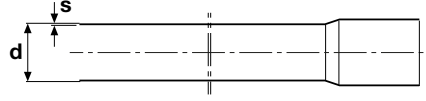

**PN 4**

Çap Dia	Basınç PN	Kod / Code 6 m	Fiyat (metre) Price (meter)	Ağırlık (Kg/m) Weight (Kg/m)	S(mm) Et kalınlığı Wall Thickness
<i>Emniyet kat sayısı (safety factor) C =2,5</i>					
75	4	100 04 075 1	2,52 €	0,65	1,8
90	4	100 04 090 1	3,05 €	0,79	1,8
<i>Emniyet kat sayısı (safety factor) C =2,0</i>					
110	4	100 04 110 1	4,47 €	1,16	2,2
125	4	100 04 125 1	5,77 €	1,5	2,5
140	4	100 04 140 1	7,02 €	1,88	2,8
160	4	100 04 160 1	9,40 €	2,43	3,2
200	4	100 04 200 1	14,63 €	3,80	4,0
225	4	100 04 225 3	18,53 €	4,81	4,5
250	4	100 04 250 3	22,43 €	5,82	4,9
280	4	100 04 280 3	28,18 €	7,32	5,5
315	4	100 04 315 3	35,69 €	9,27	6,2
355	4	100 04 355 3	45,53 €	11,8	7,0
400	4	100 04 400 3	58,01 €	15,6	7,9
450	4	100 04 450 3	80,46 €	20,9	8,9
500	4	100 04 500 3	92,78 €	24,1	9,8

**PN 6**

Çap Dia	Basınç PN	Kod / Code 6 m	Fiyat (metre) Price (meter)	Ağırlık (Kg/m) Weight (Kg/m)	S(mm) Et kalınlığı Wall Thickness
<i>Emniyet kat sayısı (safety factor) C =2,5</i>					
50	6	100 06 050 1	1,41 €	0,36	1,6
63	6	100 06 063 1	2,21 €	0,57	2,0
75	6	100 06 075 1	3,07 €	0,79	2,3
90	6	100 06 090 1	4,44 €	1,15	2,8
<i>Emniyet kat sayısı (safety factor) C =2,0</i>					
110	6	100 06 110 1	5,29 €	1,37	2,7
125	6	100 06 125 1	6,86 €	1,78	3,1
140	6	100 06 140 1	8,54 €	2,21	3,5
160	6	100 06 160 1	11,11 €	2,88	4,0
200	6	100 06 200 1	17,17 €	4,46	4,9
225	6	100 06 225 3	21,82 €	5,67	5,5
250	6	100 06 250 3	26,87 €	6,98	6,2
280	6	100 06 280 3	33,75 €	8,76	6,9
315	6	100 06 315 3	42,66 €	11,08	7,7
355	6	100 06 355 3	54,63 €	14,18	8,7
400	6	100 06 400 3	69,08 €	17,94	9,8
450	6	100 06 450 3	89,01 €	23,11	11,0
500	6	100 06 500 3	100,57 €	28,72	12,3



## U-PVC Yapıştırma Mufli Borular

### U-PVC Cement Socketed Pressure Pipes

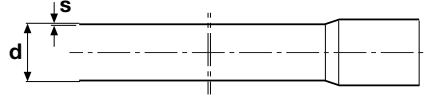

## PN 10

Çap Dia	Basınç PN	Kod / Code 6 m	Kod / Code 3 m	Fiyat (metre) Price (meter)	Ağırlık (Kg/m) Weight (Kg/m)	S(mm) Et kalınlığı Wall Thickness
<i>Emniyet kat sayısı (safety factor) C =2,5</i>						
25	10	100 10 025 1	150 10 025 1	0,64 €	0,16	1,5
32	10	100 10 032 1	150 10 032 1	0,93 €	0,24	1,6
40	10	100 10 040 1	150 10 040 1	1,36 €	0,35	1,9
50	10	100 10 050 1	150 10 050 1	2,16 €	0,56	2,4
63	10	100 10 063 1	150 10 063 1	3,35 €	0,87	3,0
75	10	100 10 075 1	150 10 075 1	4,80 €	1,24	3,6
90	10	100 10 090 1	150 10 090 1	6,86 €	1,78	4,3
<i>Emniyet kat sayısı (safety factor) C =2,0</i>						
110	10	100 10 110 1	150 10 110 1	8,32 €	2,16	4,2
125	10	100 10 125 1	150 10 125 1	10,72 €	2,78	4,8
140	10	100 10 140 1	150 10 140 1	13,52 €	3,51	5,4
160	10	100 10 160 1	150 10 160 1	17,73 €	4,60	6,2
200	10	100 10 200 1	150 10 200 1	27,42 €	7,12	7,7
225	10	100 10 225 3	150 10 225 3	34,48 €	8,95	8,6
250	10	100 10 250 3	150 10 250 3	42,81 €	11,1	9,6
280	10	100 10 280 3	150 10 280 3	53,92 €	14,0	10,7
315	10	100 10 315 3	150 10 315 3	67,00 €	17,4	12,1
355	10	100 10 355 3	150 10 355 3	85,36 €	22,1	13,6
400	10	100 10 400 3	150 10 400 3	107,85 €	28,0	15,3
450	10	100 10 450 3	150 10 450 3	137,22 €	35,6	17,2
500	10	100 10 500 3	150 10 500 3	169,32 €	43,9	19,1

## PN 16

Çap Dia	Basınç PN	Kod / Code 6 m	Kod / Code 3 m	Fiyat (metre) Price (meter)	Ağırlık (Kg/m) Weight (Kg/m)	S(mm) Et kalınlığı Wall Thickness
<i>Emniyet kat sayısı (safety factor) C =2,5</i>						
20	16	100 16 020 1	150 16 020 1	0,52 €	0,13	1,5
25	16	100 16 025 1	150 16 025 1	0,83 €	0,21	1,9
32	16	100 16 032 1	150 16 032 1	1,33 €	0,34	2,4
40	16	100 16 040 1	150 16 040 1	2,05 €	0,53	3,0
50	16	100 16 050 1	150 16 050 1	3,17 €	0,82	3,7
63	16	100 16 063 1	150 16 063 1	5,06 €	1,31	4,7
75	16	100 16 075 1	150 16 075 1	7,16 €	1,86	5,6
90	16	100 16 090 1	150 16 090 1	10,25 €	2,66	6,7
<i>Emniyet kat sayısı (safety factor) C =2,0</i>						
110	16	100 16 110 1	150 16 110 1	12,58 €	3,26	6,6
125	16	100 16 125 1	150 16 125 1	16,05 €	4,16	7,4
140	16	100 16 140 1	150 16 140 1	20,16 €	5,23	8,3
160	16	100 16 160 1	150 16 160 1	26,33 €	6,83	9,5
200	16	100 16 200 1	150 16 200 1	40,87 €	10,61	11,9
225	16	100 16 225 3	150 16 225 3	51,74 €	13,4	13,4
250	16	100 16 250 3	150 16 250 3	63,62 €	16,5	14,8
280	16	100 16 280 3	150 16 280 3	80,14 €	20,4	16,6
315	16	100 16 315 3	150 16 315 3	101,33 €	26,8	18,7
355	16	100 16 355 3	150 16 355 3	129,49 €	33,6	21,1
400	16	100 16 400 3	150 16 400 3	164,83 €	42,8	23,7
450	16	100 16 450 3	150 16 450 3	⚠		
500	16	100 16 500 3	150 16 500 3	⚠		



**U-PVC Geçme Mufllu Borular**  
Pipe With O-Ring Gasket Socketed

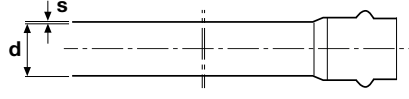

**PN 4**

Çap Dia	Basınç PN	Kod / Code 6 m	Fiyat (metre) Price (meter)	Ağırlık (Kg/m) Weight (Kg/m)	S(mm) Et kalınlığı Wall Thickness
<i>Emniyet kat sayısı (safety factor) C =2,5</i>					
75	4	101 04 075 1	2,52 €	0,65	1,8
90	4	101 04 090 1	3,05 €	0,79	1,8
<i>Emniyet kat sayısı (safety factor) C =2,0</i>					
110	4	101 04 110 1	4,46 €	1,16	2,2
125	4	101 04 125 1	5,77 €	1,50	2,5
140	4	101 04 140 1	7,25 €	1,88	2,8
160	4	101 04 160 1	9,38 €	2,43	3,2
200	4	101 04 200 1	14,63 €	3,80	4,0
225	4	101 04 225 3	18,53 €	4,81	4,5
250	4	101 04 250 3	22,43 €	5,82	4,9
280	4	101 04 280 3	28,19 €	7,32	5,5
315	4	101 04 315 3	35,69 €	9,27	6,2
355	4	101 04 355 3	45,53 €	11,8	7,0
400	4	101 04 400 3	58,23 €	15,1	7,9
450	4	101 04 450 3	80,46 €	20,6	8,9
500	4	101 04 500 3	92,72 €	24,0	9,8

**PN 6**

Çap Dia	Basınç PN	Kod / Code 6 m	Fiyat (metre) Price (meter)	Ağırlık (Kg/m) Unit Weight (Kg/m)	S(mm) Et kalınlığı Wall Thickness
<i>Emniyet kat sayısı (safety factor) C =2,5</i>					
50	6	101 06 050 1	1,41 €	0,36	1,6
63	6	101 06 063 1	2,21 €	0,57	2,0
75	6	101 06 075 1	3,07 €	0,79	2,3
90	6	101 06 090 1	4,44 €	1,15	2,8
<i>Emniyet kat sayısı (safety factor) C =2,0</i>					
110	6	101 06 110 1	5,29 €	1,43	2,7
125	6	101 06 125 1	6,86 €	1,86	3,1
140	6	101 06 140 1	8,54 €	2,36	3,5
160	6	101 06 160 1	11,11 €	3,08	4,0
200	6	101 06 200 1	17,17 €	4,72	4,9
225	6	101 06 225 3	21,82 €	5,97	5,5
250	6	101 06 250 3	26,87 €	7,48	6,2
280	6	101 06 280 3	33,75 €	9,31	6,9
315	6	101 06 315 3	42,66 €	11,7	7,7
355	6	101 06 355 3	54,63 €	14,9	8,7
400	6	101 06 400 3	69,08 €	19,0	9,8
450	6	101 06 450 3	89,01 €	24,15	11,0
500	6	101 06 500 3	100,57 €	30,0	12,3

## U-PVC Geçme Mufllu Borular

Pipe With O-Ring Gasket Socketed

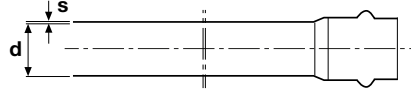

### PN 10

Çap Dia	Basınç PN	Kod / Code 6 m	Fiyat (metre) Price (meter)	Ağırlık (Kg/m) Weight (Kg/m)	S(mm) Et kalınlığı Wall Thickness
<i>Emniyet kat sayısı (safety factor) C =2,5</i>					
50	10	101 10 050 1	2,16 €	0,56	2,4
63	10	101 10 063 1	3,40 €	0,87	3,0
75	10	101 10 075 1	4,82 €	1,25	3,6
90	10	101 10 090 1	6,94 €	1,80	4,3
<i>Emniyet kat sayısı (safety factor) C =2,0</i>					
110	10	101 10 110 1	8,45 €	2,19	4,2
125	10	101 10 125 1	10,88 €	2,82	4,8
140	10	101 10 140 1	13,76 €	3,57	5,4
160	10	101 10 160 1	18,18 €	4,69	6,2
200	10	101 10 200 1	28,00 €	7,27	7,7
225	10	101 10 225 3	35,25 €	9,15	8,6
250	10	101 10 250 3	43,82 €	11,3	9,6
280	10	101 10 280 3	55,07 €	14,3	10,7
315	10	101 10 315 3	69,82 €	18,1	12,1
355	10	101 10 355 3	88,26 €	22,9	13,6
400	10	101 10 400 3	112,86 €	29,3	15,3
450	10	101 10 450 3	142,65 €	32,0	17,2
500	10	101 10 500 3	176,48 €		19,1

### PN 16

Çap Dia	Basınç PN	Kod / Code 6 m	Fiyat (metre) Price (meter)	Ağırlık (Kg/m) Unit Weight (Kg/m)	S(mm) Et kalınlığı Wall Thickness
<i>Emniyet kat sayısı (safety factor) C =2,5</i>					
50	16	101 16 050 1	3,17 €	0,82	3,7
63	16	101 16 063 1	5,07 €	1,31	4,7
75	16	101 16 075 1	7,24 €	1,88	5,6
90	16	101 16 090 1	10,37 €	2,69	6,7
<i>Emniyet kat sayısı (safety factor) C =2,0</i>					
110	16	101 16 110 1	12,77 €	3,31	6,6
125	16	101 16 125 1	16,30 €	4,23	7,4
140	16	101 16 140 1	20,53 €	5,33	8,3
160	16	101 16 160 1	26,82 €	6,96	9,5
200	16	101 16 200 1	42,02 €	10,9	11,9
225	16	101 16 225 3	53,44 €	13,8	13,4
250	16	101 16 250 3	65,69 €	17,0	14,8
280	16	101 16 280 3	82,49 €	21,4	16,6
315	16	101 16 315 3	104,94 €	27,2	18,7
355	16	101 16 355 3	133,52 €	34,6	21,1
400	16	101 16 400 3	172,00 €	44,6	23,7
450	16	101 16 450 3	☎		
500	16	101 16 500 3	☎		



**U-PVC Zonder Boru**  
U-PVC Industry Pipes

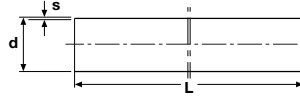

**PN 20**

Çap Dia	Basınç PN	Kod /Code 3 m	Fiyat (metre) Price (meter)	Birim ağırlık (Kg/m) Unit Weight (Kg/m)	S (mm) Et kalınlığı Wall Thickness
<i>Emniyet kat sayısı (safety factor) C =2,5</i>					
20	20	102 20 020 1	0,85 €	0,17	1,9
25	20	102 20 025 1	1,29 €	0,27	2,3
32	20	102 20 032 1	1,95 €	0,41	2,9
40	20	102 20 040 1	3,05 €	0,65	3,7
50	20	102 20 050 1	4,56 €	1,00	4,6
63	20	102 20 063 1	7,40 €	1,59	5,8
75	20	102 20 075 1	10,30 €	2,21	6,8
90	20	102 20 090 1	14,95 €	3,20	8,2
<i>Emniyet kat sayısı (safety factor) C =2,0</i>					
110	20	102 20 110 1	18,50 €	3,99	8,1
125	20	102 20 125 1	23,50 €	5,10	8,7
140	20	102 20 140 1	29,80 €	6,38	9,2
160	20	102 20 160 1	33,60 €	7,34	11,8
200	20	102 20 200 1	59,50 €	13,0	14,7

**U-PVC Zonder Boru**  
U-PVC Industry Pipes

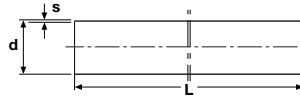

**PN 25**

Çap Dia	Basınç PN	Kod /Code 3 m	Fiyat (metre) Price (meter)	Birim ağırlık (Kg/m) Unit Weight (Kg/m)	S(mm) Et kalınlığı Wall Thickness
<i>Emniyet kat sayısı (safety factor) C =2,5</i>					
20	25	102 25 020 1	0,96 €	0,19	2,3
25	25	102 25 025 1	1,42 €	0,29	2,8
32	25	102 25 032 1	2,32 €	0,49	3,6
40	25	102 25 040 1	3,75 €	0,81	4,5
50	25	102 25 050 1	5,38 €	1,19	5,6
63	25	102 25 063 1	8,76 €	1,9	7,1
75	25	102 25 075 1	12,33 €	2,67	8,4
90	25	102 25 090 1	17,69 €	3,83	10,0
<i>Emniyet kat sayısı (safety factor) C =2,0</i>					
110	25	102 25 110 1	22,00 €	4,78	10,0
125	25	102 25 125 1	28,32 €	6,2	11,4
140	25	102 25 140 1	35,53 €	7,68	12,6
160	25	102 25 160 1	46,02 €	10,1	14,6
200	25	102 25 200 1	71,38 €	15,7	18,2

## U-PVC Şeffaf Boru (Transparan)

### U-PVC Industry Pipes (Transparent)

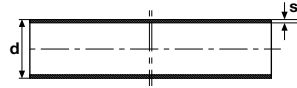
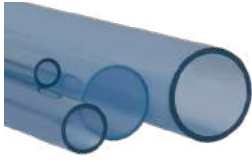

Çap Dia	Basınç PN	Kod / Code 3 m	Fiyat (metre) Price (meter)	(Kg/m) (Kg/m)	S (mm) Et kalınlığı Wall Thickness
20	10	231 020 0208	6,01 €	0,13	1,5
25	10	231 020 0258	8,22 €	0,17	1,5
32	10	231 020 0328	9,41 €	0,26	1,8
40	10	231 020 0408	13,92 €	0,36	2,0
50	10	231 020 0508	16,95 €	0,55	2,4
63	10	231 020 0638	45,10 €	0,85	3,0
75	10	231 020 0758	45,54 €	1,22	3,6
90	10	231 020 0908	64,81 €	1,75	4,3
110	10	231 020 1108	94,88 €	2,61	5,3
125	10	231 020 1258	112,00 €	-	-
140	10	231 020 1408	☎	-	-
160	10	231 020 1608	☎	-	-
200	10	231 020 2008	☎	-	-

## U-PVC Özel Amaçlı Borular

### U-PVC Specific Usage Pipes

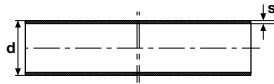

Çap Dia	Kod / Code 3 m	Fiyat (metre) Price (meter)	(Kg/m) (Kg/m)	S (mm) Et kalınlığı Wall Thickness
8	121 15 008 1	1,21 €	0,04	1,5
9	121 15 009 1	1,23 €	0,05	1,5
10	121 15 010 1	1,24 €	0,06	1,5
10	121 20 010 1	1,24 €	0,04	1,0
11	121 15 011 1	1,25 €	0,06	1,5
12	121 15 012 1	1,26 €	0,07	1,5
12	121 20 012 1	1,26 €	0,09	2,0
14	121 20 014 1	1,27 €	0,11	2,0
16	121 20 016 1	1,28 €	0,13	2,0
17	121 10 017 1	1,29 €	0,07	1,0
17	121 15 017 1	1,29 €	0,11	1,5
18	121 15 018 1	1,30 €	0,11	1,5
20	121 10 020 1	1,30 €	0,09	1,0
20	121 15 020 1	1,32 €	0,13	1,5
20	121 20 020 1	1,34 €	0,17	2,0
21	121 20 021 1	1,34 €	0,18	2,0
22	121 25 022 1	1,36 €	0,23	2,5
23	121 10 023 1	1,36 €	0,10	1,0
27	121 20 027 1	1,38 €	0,23	2,0
32	121 15 032 1	1,90 €	0,21	1,5
33	121 20 033 1	2,42 €	0,29	2,0
40	121 20 040 1	2,75 €	0,36	2,0
42	121 20 042 1	3,19 €	0,38	2,0
50	121 20 050 1	4,40 €	0,46	2,0
63	121 20 063 1	11,00 €	0,58	2,0

**U-PVC Yapıştırma Mufli Temiz Su Deve Boynu**  
U-PVC Solvent Cement Socket Long Bend



**11° PN 10**

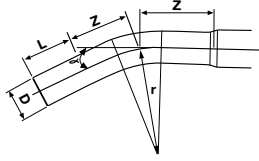

Çap Dia	Basınç (PN)	Kod Code	Fiyat (Adet) Price (Pcs)	Açı Angle	Yarıçap (r)	Z (mm)	L (mm)
<i>Emniyet kat sayısı (safety factor) C =2,5</i>							
25	10	105 10 025 6	3,24 €	11°	63	31	18,5
32	10	105 10 032 6	3,24 €	11°	80	40	22
40	10	105 10 040 6	3,24 €	11°	100	50	26
50	10	105 10 050 6	3,24 €	11°	125	62	31
63	10	105 10 063 6	4,63 €	11°	221	46	37,5
75	10	105 10 075 6	6,98 €	11°	263	55	43,5
90	10	105 10 090 6	11,14 €	11°	315	66	51
<i>Emniyet kat sayısı (safety factor) C =2,0</i>							
110	10	105 10 110 6	15,82 €	11°	385	81	61
125	10	105 10 125 6	20,38 €	11°	438	92	68,5
140	10	105 10 140 6	28,06 €	11°	490	103	76
160	10	105 10 160 6	39,87 €	11°	560	118	86
200	10	105 10 200 6	75,89 €	11°	700	147	106
225	10	105 10 225 6	107,26 €	11°	788	166	118,5
250	10	105 10 250 6	156,72 €	11°	875	184	131
280	10	105 10 280 6	233,71 €	11°	980	206	146
315	10	105 10 315 6	308,42 €	11°	1103	232	163,5
355	10	105 10 355 6	404,85 €	11°	1243	262	183,5
400	10	105 10 400 6	591,84 €	11°	1400	295	206
450	10	105 10 450 6	☎	11°	1575	332	
500	10	105 10 500 6	☎				

**11° PN 16**

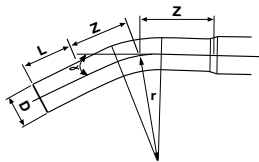

Çap Dia	Basınç PN	Kod Code	Fiyat (Adet) Price (Pcs)	Açı Angle	Yarıçap R	Z mm	L mm
<i>Emniyet kat sayısı (safety factor) C =2,5</i>							
25	16	105 16 025 6	5,13 €	11°	63	31	18,5
32	16	105 16 032 6	5,13 €	11°	80	40	22
40	16	105 16 040 6	5,13 €	11°	100	50	26
50	16	105 16 050 6	5,13 €	11°	125	62	31
63	16	105 16 063 6	7,88 €	11°	221	46	37,5
75	16	105 16 075 6	12,71 €	11°	263	55	43,5
90	16	105 16 090 6	20,18 €	11°	315	66	51
<i>Emniyet kat sayısı (safety factor) C =2,0</i>							
110	16	105 16 110 6	26,89 €	11°	385	81	61
125	16	105 16 125 6	34,65 €	11°	438	92	68,5
140	16	105 16 140 6	47,70 €	11°	490	103	76
160	16	105 16 160 6	67,79 €	11°	560	118	86
200	16	105 16 200 6	129,02 €	11°	700	147	106
225	16	105 16 225 6	182,59 €	11°	788	166	118,5
250	16	105 16 250 6	266,42 €	11°	875	184	131
280	16	105 16 280 6	450,13 €	11°	980	206	146
315	16	105 16 315 6	524,54 €	11°	1103	232	163,5
355	16	105 16 355 6	688,64 €	11°	1243	262	183,5
400	16	105 16 400 6	1.006,29 €	11°	1400	295	206
450	16	105 16 450 6	☎	11°	1575	332	
500	16	105 16 500 6	☎	11°	1750	369	

## U-PVC Yapıştırma Mufli Temiz Su Deve Boynu

### U-PVC Solvent Cement Socket Long Bend

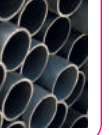

#### 22,5° PN 10

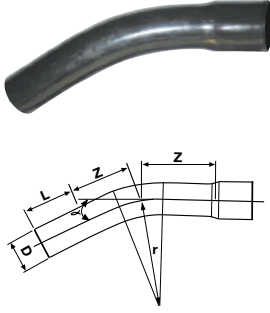

Çap Dia	Basınç PN	Kod Code	Fiyat (Adet) Price (Pcs)	Açı Angle	Yarıçap R	Z mm	L mm
<i>Emniyet kat sayısı (safety factor) C =2,5</i>							
25	10	106 10 025 6	3,24 €	22,5°	63	37	18,5
32	10	106 10 032 6	3,24 €	22,5°	80	48	22
40	10	106 10 040 6	3,24 €	22,5°	100	59	26
50	10	106 10 050 6	3,24 €	22,5°	125	74	31
63	10	106 10 063 6	4,63 €	22,5°	221	68	37,5
75	10	106 10 075 6	6,98 €	22,5°	263	81	43,5
90	10	106 10 090 6	11,14 €	22,5°	315	97	51
<i>Emniyet kat sayısı (safety factor) C =2,0</i>							
110	10	106 10 110 6	15,82 €	22,5°	385	119	61
125	10	106 10 125 6	20,38 €	22,5°	438	135	68,5
140	10	106 10 140 6	28,06 €	22,5°	490	151	76
160	10	106 10 160 6	39,87 €	22,5°	560	173	86
200	10	106 10 200 6	75,89 €	22,5°	700	216	106
225	10	106 10 225 6	107,26 €	22,5°	788	243	118,5
250	10	106 10 250 6	156,72 €	22,5°	875	270	131
280	10	106 10 280 6	233,71 €	22,5°	980	302	146
315	10	106 10 315 6	308,42 €	22,5°	1103	340	163,5
355	10	106 10 355 6	404,85 €	22,5°	1243	384	183,5
400	10	106 10 400 6	591,84 €	22,5°	1400	432	206
450	10	106 10 450 6	☎	22,5°	1575	486	
500	10	106 10 500 6	☎	22,5°	1750	540	

#### 22,5° PN 16

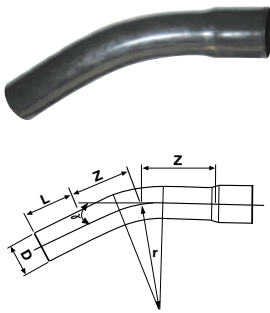

Çap Dia	Basınç PN	Kod Code	Fiyat (Adet) Price (Pcs)	Açı Angle	Yarıçap R	Z mm	L mm
<i>Emniyet kat sayısı (safety factor) C =2,5</i>							
25	16	106 16 025 6	5,13 €	22,5°	63	37	18,5
32	16	106 16 032 6	5,13 €	22,5°	80	48	22
40	16	106 16 040 6	5,13 €	22,5°	100	59	26
50	16	106 16 050 6	5,13 €	22,5°	125	74	31
63	16	106 16 063 6	7,88 €	22,5°	221	68	37,5
75	16	106 16 075 6	12,71 €	22,5°	263	81	43,5
90	16	106 16 090 6	20,18 €	22,5°	315	97	51
<i>Emniyet kat sayısı (safety factor) C =2,0</i>							
110	16	106 16 110 6	26,89 €	22,5°	385	119	61
125	16	106 16 125 6	34,65 €	22,5°	438	135	68,5
140	16	106 16 140 6	47,70 €	22,5°	490	151	76
160	16	106 16 160 6	67,79 €	22,5°	560	173	86
200	16	106 16 200 6	129,02 €	22,5°	700	216	106
225	16	106 16 225 6	182,59 €	22,5°	788	243	118,5
250	16	106 16 250 6	266,42 €	22,5°	875	270	131
280	16	106 16 280 6	450,13 €	22,5°	980	302	146
315	16	106 16 315 6	524,54 €	22,5°	1103	340	163,5
355	16	106 16 355 6	688,64 €	22,5°	1243	384	183,5
400	16	106 16 400 6	1.006,29 €	22,5°	1400	432	206
450	16	106 16 450 6	☎	22,5°	1575	486	
500	16	106 16 500 6	☎	22,5°	1750	540	

**U-PVC Yapıştırma Mufllu Temiz Su Deve Boynu**  
U-PVC Solvent Cement Socket Long Bend

**30° PN 10**

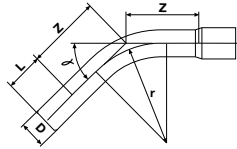

Çap Dia	Basınç PN	Kod Code	Fiyat (Adet) Price (Pcs)	Açı Angle	Yarıçap R	Z mm	L mm
<i>Emniyet kat sayısı (safety factor) C =2,5</i>							
25	10	107 10 025 6	3,69 €	30°	63	42	18,5
32	10	107 10 032 6	3,69 €	30°	80	53	22
40	10	107 10 040 6	3,69 €	30°	100	67	26
50	10	107 10 050 6	3,69 €	30°	125	84	31
63	10	107 10 063 6	5,36 €	30°	221	84	37,5
75	10	107 10 075 6	9,05 €	30°	263	100	43,5
90	10	107 10 090 6	12,62 €	30°	315	120	51
<i>Emniyet kat sayısı (safety factor) C =2,0</i>							
110	10	107 10 110 6	16,69 €	30°	385	147	61
125	10	107 10 125 6	26,84 €	30°	438	167	68,5
140	10	107 10 140 6	36,31 €	30°	490	187	76
160	10	107 10 160 6	47,38 €	30°	560	214	86
200	10	107 10 200 6	94,79 €	30°	700	268	106
225	10	107 10 225 6	126,92 €	30°	788	301	118,5
250	10	107 10 250 6	180,78 €	30°	875	334	131
280	10	107 10 280 6	300,13 €	30°	980	375	146
315	10	107 10 315 6	379,42 €	30°	1103	421	163,5
355	10	107 10 355 6	518,19 €	30°	1243	475	183,5
400	10	107 10 400 6	789,38 €	30°	1400	535	206
450	10	107 10 450 6	☎	30°	1575	602	
500	10	107 10 500 6	☎	30°	1750	669	

**30° PN 16**

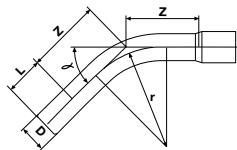

Çap Dia	Basınç PN	Kod Code	Fiyat (Adet) Price (Pcs)	Açı Angle	Yarıçap R	Z mm	L mm
<i>Emniyet kat sayısı (safety factor) C =2,5</i>							
25	16	107 16 025 6	5,65 €	30°	63	42	18,5
32	16	107 16 032 6	5,65 €	30°	80	53	22
40	16	107 16 040 6	5,65 €	30°	100	67	26
50	16	107 16 050 6	5,65 €	30°	125	84	31
63	16	107 16 063 6	9,52 €	30°	221	84	37,5
75	16	107 16 075 6	15,43 €	30°	263	100	43,5
90	16	107 16 090 6	21,49 €	30°	315	120	51
<i>Emniyet kat sayısı (safety factor) C =2,0</i>							
110	16	107 16 110 6	28,31 €	30°	385	147	61
125	16	107 16 125 6	45,59 €	30°	438	167	68,5
140	16	107 16 140 6	61,81 €	30°	490	187	76
160	16	107 16 160 6	80,42 €	30°	560	214	86
200	16	107 16 200 6	160,78 €	30°	700	268	106
225	16	107 16 225 6	215,01 €	30°	788	301	118,5
250	16	107 16 250 6	306,38 €	30°	875	334	131
280	16	107 16 280 6	511,82 €	30°	980	375	146
315	16	107 16 315 6	644,51 €	30°	1103	421	163,5
355	16	107 16 355 6	846,83 €	30°	1243	475	183,5
400	16	107 16 400 6	1.341,26 €	30°	1400	535	206
450	16	107 16 450 6	☎	30°	1575	602	
500	16	107 16 500 6	☎	30°	1750	669	



## U-PVC Yapıştırma Mufli Temiz Su Deve Boynu

### U-PVC Solvent Cement Socket Long Bend



#### 45° PN 10

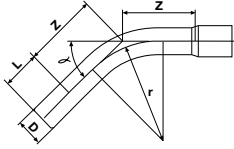

Çap Dia	Basınç PN	Kod Code	Fiyat (Adet) Price (Pcs)	Açı Angle	Yarıçap R	Z mm	L mm
<i>Emniyet kat sayısı (safety factor) C =2,5</i>							
25	10	108 10 025 6	3,69 €	45°	63	51	18,5
32	10	108 10 032 6	3,69 €	45°	80	65	22
40	10	108 10 040 6	3,69 €	45°	100	81	26
50	10	108 10 050 6	3,69 €	45°	125	102	31
63	10	108 10 063 6	5,36 €	45°	221	117	37,5
75	10	108 10 075 6	9,05 €	45°	263	139	43,5
90	10	108 10 090 6	12,62 €	45°	315	166	51
<i>Emniyet kat sayısı (safety factor) C =2,0</i>							
110	10	108 10 110 6	16,69 €	45°	385	203	61
125	10	108 10 125 6	26,84 €	45°	438	231	68,5
140	10	108 10 140 6	36,31 €	45°	490	259	76
160	10	108 10 160 6	47,38 €	45°	560	296	86
200	10	108 10 200 6	94,79 €	45°	700	370	106
225	10	108 10 225 6	126,92 €	45°	788	416	118,5
250	10	108 10 250 6	180,78 €	45°	875	462	131
280	10	108 10 280 6	300,13 €	45°	980	518	146
315	10	108 10 315 6	379,42 €	45°	1103	583	163,5
355	10	108 10 355 6	518,19 €	45°	1243	656	183,5
400	10	108 10 400 6	789,38 €	45°	1400	740	206
450	10	108 10 450 6	☎	45°	1575	832	
500	10	108 10 500 6	☎	45°	1750	925	

#### 45° PN 16

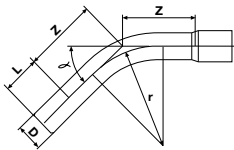

Çap Dia	Basınç PN	Kod Code	Fiyat (Adet) Price (Pcs)	Açı Angle	Yarıçap R	Z mm	L mm
<i>Emniyet kat sayısı (safety factor) C =2,5</i>							
25	16	108 16 025 6	5,65 €	45°	63	51	18,5
32	16	108 16 032 6	5,65 €	45°	80	65	22
40	16	108 16 040 6	5,65 €	45°	100	81	26
50	16	108 16 050 6	5,65 €	45°	125	102	31
63	16	108 16 063 6	9,52 €	45°	221	117	37,5
75	16	108 16 075 6	15,43 €	45°	263	139	43,5
90	16	108 16 090 6	21,49 €	45°	315	166	51
<i>Emniyet kat sayısı (safety factor) C =2,0</i>							
110	16	108 16 110 6	28,31 €	45°	385	203	61
125	16	108 16 125 6	45,59 €	45°	438	231	68,5
140	16	108 16 140 6	61,81 €	45°	490	259	76
160	16	108 16 160 6	80,42 €	45°	560	296	86
200	16	108 16 200 6	160,78 €	45°	700	370	106
225	16	108 16 225 6	215,01 €	45°	788	416	118,5
250	16	108 16 250 6	306,38 €	45°	875	462	131
280	16	108 16 280 6	511,82 €	45°	980	518	146
315	16	108 16 315 6	644,51 €	45°	1103	583	163,5
355	16	108 16 355 6	846,83 €	45°	1243	656	183,5
400	16	108 16 400 6	1.341,26 €	45°	1400	740	206
450	16	108 16 450 6	☎	45°	1575	832	
500	16	108 16 500 6	☎	45°	1750	925	

**U-PVC Yapıştırma Mufllu Temiz Su Deve Boynu**  
U-PVC Solvent Cement Socket Long Bend

**60° PN 10**

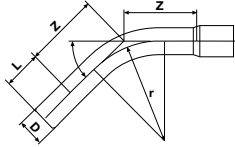

Çap Dia	Basınç PN	Kod Code	Fiyat (Adet) Price (Pcs)	Açı Angle	Yarıçap R	Z mm	L mm
<i>Emniyet kat sayısı (safety factor) C =2,5</i>							
25	10	109 10 025 6	4,12 €	60°	63	61	18,5
32	10	109 10 032 6	4,12 €	60°	80	78	22
40	10	109 10 040 6	4,12 €	60°	100	98	26
50	10	109 10 050 6	4,12 €	60°	125	122	31
63	10	109 10 063 6	6,17 €	60°	221	153	37,5
75	10	109 10 075 6	9,81 €	60°	263	182	43,5
90	10	109 10 090 6	17,33 €	60°	315	218	51
<i>Emniyet kat sayısı (safety factor) C =2,0</i>							
110	10	109 10 110 6	22,23 €	60°	385	266	61
125	10	109 10 125 6	35,42 €	60°	438	303	68,5
140	10	109 10 140 6	46,84 €	60°	490	339	76
160	10	109 10 160 6	64,26 €	60°	560	387	86
200	10	109 10 200 6	127,42 €	60°	700	484	106
225	10	109 10 225 6	180,77 €	60°	788	545	118,5
250	10	109 10 250 6	259,42 €	60°	875	605	131
280	10	109 10 280 6	348,48 €	60°	980	678	146
315	10	109 10 315 6	644,69 €	60°	1103	763	163,5
355	10	109 10 355 6	737,62 €	60°	1243	859	183,5
400	10	109 10 400 6	1.134,50 €	60°	1400	968	206
450	10	109 10 450 6	☎	60°	1575	1089	
500	10	109 10 500 6	☎	60°	1750	1210	

**60° PN 16**

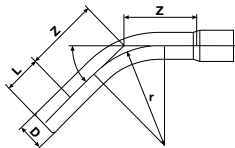

Çap Dia	Basınç PN	Kod Code	Fiyat (Adet) Price (Pcs)	Açı Angle	Yarıçap R	Z mm	L mm
<i>Emniyet kat sayısı (safety factor) C =2,5</i>							
25	16	109 16 025 6	6,08 €	60°	63	61	18,5
32	16	109 16 032 6	6,08 €	60°	80	78	22
40	16	109 16 040 6	6,08 €	60°	100	98	26
50	16	109 16 050 6	6,08 €	60°	125	122	31
63	16	109 16 063 6	10,48 €	60°	221	153	37,5
75	16	109 16 075 6	16,69 €	60°	263	182	43,5
90	16	109 16 090 6	29,43 €	60°	315	218	51
<i>Emniyet kat sayısı (safety factor) C =2,0</i>							
110	16	109 16 110 6	37,82 €	60°	385	266	61
125	16	109 16 125 6	60,21 €	60°	438	303	68,5
140	16	109 16 140 6	79,63 €	60°	490	339	76
160	16	109 16 160 6	110,00 €	60°	560	387	86
200	16	109 16 200 6	215,62 €	60°	700	484	106
225	16	109 16 225 6	307,10 €	60°	788	545	118,5
250	16	109 16 250 6	438,24 €	60°	875	605	131
280	16	109 16 280 6	591,36 €	60°	980	678	146
315	16	109 16 315 6	1.095,78 €	60°	1103	763	163,5
355	16	109 16 355 6	1.258,40 €	60°	1243	859	183,5
400	16	109 16 400 6	1.928,26 €	60°	1400	968	206
450	16	109 16 450 6	☎	60°	1575	1089	
500	16	109 16 500 6	☎	60°	1750	1210	

## U-PVC Yapıştırma Mufllu Temiz Su Deve Boynu

### U-PVC Solvent Cement Socket Long Bend



### 90° PN 10

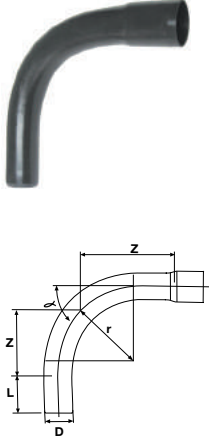

Çap Dia	Basınç PN	Kod Code	Fiyat (Adet) Price (Pcs)	Açı Angle	Yarıçap R	Z mm	L mm
<i>Emniyet kat sayısı (safety factor) C =2,5</i>							
25	10	110 10 025 6	4,12 €	90°	63	88	18,5
32	10	110 10 032 6	4,12 €	90°	80	112	22
40	10	110 10 040 6	4,12 €	90°	100	140	26
50	10	110 10 050 6	4,12 €	90°	125	175	31
63	10	110 10 063 6	6,17 €	90°	221	246	37,5
75	10	110 10 075 6	9,81 €	90°	263	293	43,5
90	10	110 10 090 6	17,33 €	90°	315	351	51
<i>Emniyet kat sayısı (safety factor) C =2,0</i>							
110	10	110 10 110 6	22,23 €	90°	385	429	61
125	10	110 10 125 6	35,42 €	90°	438	488	68,5
140	10	110 10 140 6	46,84 €	90°	490	546	76
160	10	110 10 160 6	64,26 €	90°	560	624	86
200	10	110 10 200 6	127,42 €	90°	700	780	106
225	10	110 10 225 6	180,77 €	90°	788	878	118,5
250	10	110 10 250 6	259,42 €	90°	875	975	131
280	10	110 10 280 6	348,48 €	90°	980	1092	146
315	10	110 10 315 6	644,69 €	90°	1103	1229	163,5
355	10	110 10 355 6	737,62 €	90°	1243	1385	183,5
400	10	110 10 400 6	1.134,50 €	90°	1400	1560	206
450	10	110 10 450 6	☎	90°	1575	1755	
500	10	110 10 500 6	☎	90°	1750	1950	

### 90° PN 16

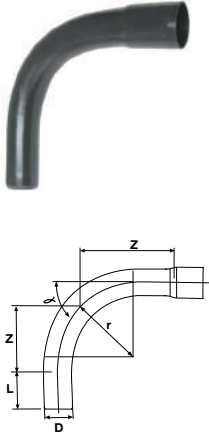

Çap Dia	Basınç PN	Kod Code	Fiyat (Adet) Price (Pcs)	Açı Angle	Yarıçap R	Z mm	L mm
<i>Emniyet kat sayısı (safety factor) C =2,5</i>							
25	16	110 16 025 6	6,08 €	90°	63	88	18,5
32	16	110 16 032 6	6,08 €	90°	80	112	22
40	16	110 16 040 6	6,08 €	90°	100	140	26
50	16	110 16 050 6	6,08 €	90°	125	175	31
63	16	110 16 063 6	10,48 €	90°	221	246	37,5
75	16	110 16 075 6	16,69 €	90°	263	293	43,5
90	16	110 16 090 6	29,43 €	90°	315	351	51
<i>Emniyet kat sayısı (safety factor) C =2,0</i>							
110	16	110 16 110 6	37,82 €	90°	385	429	61
125	16	110 16 125 6	60,21 €	90°	438	488	68,5
140	16	110 16 140 6	79,63 €	90°	490	546	76
160	16	110 16 160 6	110,00 €	90°	560	624	86
200	16	110 16 200 6	215,62 €	90°	700	780	106
225	16	110 16 225 6	307,10 €	90°	788	878	118,5
250	16	110 16 250 6	438,24 €	90°	875	975	131
280	16	110 16 280 6	591,36 €	90°	980	1092	146
315	16	110 16 315 6	1.095,78 €	90°	1103	1229	163,5
355	16	110 16 355 6	1.258,40 €	90°	1243	1385	183,5
400	16	110 16 400 6	1.928,26 €	90°	1400	1560	206
450	16	110 16 450 6	☎	90°	1575	1755	
500	16	110 16 500 6	☎	90°	1750	1950	

**U-PVC Geçme Mufllu Temiz Su Deve Boynu**  
U-PVC Long Bend With O-Ring Socket

**11° PN 10**

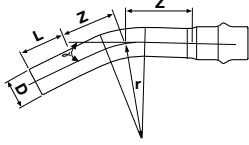

Çap Dia	Basınç PN	Kod Code	Fiyat (Adet) Price (Pcs)	Açı Angle	Yarıçap R	Z mm	L mm
<i>Emniyet kat sayısı (safety factor) C =2,5</i>							
50	10	111 10 050 6	3,24 €	11°	125	62	86
63	10	111 10 063 6	4,63 €	11°	221	46	90
75	10	111 10 075 6	6,98 €	11°	263	55	94
90	10	111 10 090 6	11,14 €	11°	315	66	97
<i>Emniyet kat sayısı (safety factor) C =2,0</i>							
110	10	111 10 110 6	15,84 €	11°	385	81	104
125	10	111 10 125 6	20,38 €	11°	438	92	108
140	10	111 10 140 6	28,04 €	11°	490	103	112
160	10	111 10 160 6	39,87 €	11°	560	118	119
200	10	111 10 200 6	75,91 €	11°	700	147	129
225	10	111 10 225 6	107,26 €	11°	788	166	136
250	10	111 10 250 6	156,74 €	11°	875	184	143
280	10	111 10 280 6	233,71 €	11°	980	206	152
315	10	111 10 315 6	308,45 €	11°	1103	232	160
355	10	111 10 355 6	404,85 €	11°	1243	262	169
400	10	111 10 400 6	591,84 €	11°	1400	295	178
450	10	111 10 500 6	☎	11°	1575	332	
500	10	111 10 500 6	☎	11°	1750	369	

**11° PN 16**

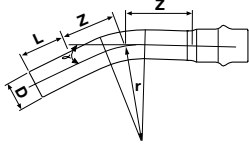

Çap Dia	Basınç PN	Kod Code	Fiyat (Adet) Price (Pcs)	Açı Angle	Yarıçap R	Z mm	L mm
<i>Emniyet kat sayısı (safety factor) C =2,5</i>							
50	16	111 16 050 6	5,15 €	11°	125	62	86
63	16	111 16 063 6	7,88 €	11°	221	46	90
75	16	111 16 075 6	12,71 €	11°	263	55	94
90	16	111 16 090 6	20,20 €	11°	315	66	97
<i>Emniyet kat sayısı (safety factor) C =2,0</i>							
110	16	111 16 110 6	26,89 €	11°	385	81	104
125	16	111 16 125 6	34,65 €	11°	438	92	108
140	16	111 16 140 6	47,70 €	11°	490	103	112
160	16	111 16 160 6	67,79 €	11°	560	118	119
200	16	111 16 200 6	129,02 €	11°	700	147	129
225	16	111 16 225 6	182,59 €	11°	788	166	136
250	16	111 16 250 6	266,42 €	11°	875	184	143
280	16	111 16 280 6	397,33 €	11°	980	206	152
315	16	111 16 315 6	524,53 €	11°	1103	232	160
355	16	111 16 355 6	688,66 €	11°	1243	262	169
400	16	111 16 400 6	1.006,29 €	11°	1400	295	178
450	16	111 16 500 6	☎	11°	1575	332	
500	16	111 10 500 6	☎	11°	1750	369	

## U-PVC Geçme Mufllu Temiz Su Deve Boynu

### U-PVC Long Bend With O-Ring Socket

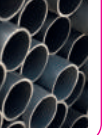

#### 22,5° PN 10

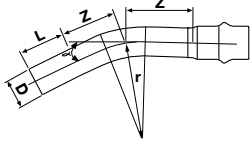

Çap Dia	Basınç PN	Kod Code	Fiyat (Adet) Price (Pcs)	Açı Angle	Yarıçap R	Z mm	L mm
<i>Emniyet kat sayısı (safety factor) C =2,5</i>							
50	10	112 10 050 6	3,24 €	22,5°	125	74	86
63	10	112 10 063 6	4,63 €	22,5°	221	68	90
75	10	112 10 075 6	6,98 €	22,5°	263	81	94
90	10	112 10 090 6	11,14 €	22,5°	315	97	97
<i>Emniyet kat sayısı (safety factor) C =2,0</i>							
110	10	112 10 110 6	15,84 €	22,5°	385	119	104
125	10	112 10 125 6	20,38 €	22,5°	438	135	108
140	10	112 10 140 6	28,04 €	22,5°	490	151	112
160	10	112 10 160 6	39,87 €	22,5°	560	173	119
200	10	112 10 200 6	75,91 €	22,5°	700	216	129
225	10	112 10 225 6	107,26 €	22,5°	788	243	136
250	10	112 10 250 6	156,74 €	22,5°	875	270	143
280	10	112 10 280 6	233,71 €	22,5°	980	302	152
315	10	112 10 315 6	308,45 €	22,5°	1103	340	160
355	10	112 10 355 6	404,85 €	22,5°	1243	384	169
400	10	112 10 400 6	591,84 €	22,5°	1400	432	178
450	10	112 10 500 6	☎	22,5°	1575	486	
500	10	112 10 500 6	☎	22,5°	1750	540	

#### 22,5° PN 16

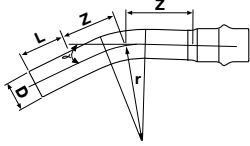

Çap Dia	Basınç PN	Kod Code	Fiyat (Adet) Price (Pcs)	Açı Angle	Yarıçap R	Z mm	L mm
<i>Emniyet kat sayısı (safety factor) C =2,5</i>							
50	16	112 16 050 6	5,15 €	22,5°	125	74	86
63	16	112 16 063 6	7,88 €	22,5°	221	68	90
75	16	112 16 075 6	12,71 €	22,5°	263	81	94
90	16	112 16 090 6	20,20 €	22,5°	315	97	97
<i>Emniyet kat sayısı (safety factor) C =2,0</i>							
110	16	112 16 110 6	26,89 €	22,5°	385	119	104
125	16	112 16 125 6	34,65 €	22,5°	438	135	108
140	16	112 16 140 6	47,70 €	22,5°	490	151	112
160	16	112 16 160 6	67,79 €	22,5°	560	173	119
200	16	112 16 200 6	129,02 €	22,5°	700	216	129
225	16	112 16 225 6	182,59 €	22,5°	788	243	136
250	16	112 16 250 6	266,42 €	22,5°	875	270	143
280	16	112 16 280 6	397,33 €	22,5°	980	302	152
315	16	112 16 315 6	524,53 €	22,5°	1103	340	160
355	16	112 16 355 6	688,66 €	22,5°	1243	384	169
400	16	112 16 400 6	1.006,29 €	22,5°	1400	432	178
450	16	112 16 450 6	☎	22,5°	1575	486	
500	16	112 16 500 6	☎	22,5°	1750	540	

**U-PVC Geçme Mufllu Temiz Su Deve Boynu**  
U-PVC Long Bend With O-Ring Socket



**30° PN 10**

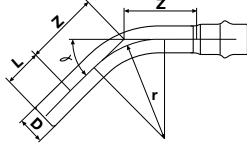

Çap Dia	Basınç PN	Kod Code	Fiyat (Adet) Price (Pcs)	Açı Angle	Yarıçap R	Z mm	L mm
<i>Emniyet kat sayısı (safety factor) C =2,5</i>							
50	10	113 10 050 6	3,69 €	30°	125	84	86
63	10	112 10 063 6	5,36 €	30°	221	84	90
75	10	113 10 075 6	9,07 €	30°	263	100	94
90	10	113 10 090 6	12,62 €	30°	315	120	97
<i>Emniyet kat sayısı (safety factor) C =2,0</i>							
110	10	113 10 110 6	16,69 €	30°	385	147	104
125	10	113 10 125 6	26,84 €	30°	438	167	108
140	10	113 10 140 6	36,31 €	30°	490	187	112
160	10	113 10 160 6	47,39 €	30°	560	214	119
200	10	113 10 200 6	94,79 €	30°	700	268	129
225	10	113 10 225 6	126,94 €	30°	788	301	136
250	10	113 10 250 6	180,78 €	30°	875	334	143
280	10	113 10 280 6	300,13 €	30°	980	375	152
315	10	113 10 315 6	379,42 €	30°	1103	421	160
355	10	113 10 355 6	518,19 €	30°	1243	475	169
400	10	113 10 400 6	789,36 €	30°	1400	535	178
450	10	113 10 450 6	☎	30°	1575	602	
500	10	113 10 500 6	☎	30°	1750	669	

**30° PN 16**

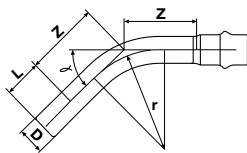

Çap Dia	Basınç PN	Kod Code	Fiyat (Adet) Price (Pcs)	Açı Angle	Yarıçap R	Z mm	L mm
<i>Emniyet kat sayısı (safety factor) C =2,5</i>							
50	16	113 16 050 6	5,65 €	30°	125	84	86
63	16	113 16 063 6	9,52 €	30°	221	84	90
75	16	113 16 075 6	15,43 €	30°	263	100	94
90	16	113 16 090 6	21,49 €	30°	315	120	97
<i>Emniyet kat sayısı (safety factor) C =2,0</i>							
110	16	113 16 110 6	28,31 €	30°	385	147	104
125	16	113 16 125 6	45,59 €	30°	438	167	108
140	16	113 16 140 6	61,81 €	30°	490	187	112
160	16	113 16 160 6	80,41 €	30°	560	214	119
200	16	113 16 200 6	160,78 €	30°	700	268	129
225	16	113 16 225 6	215,01 €	30°	788	301	136
250	16	113 16 250 6	306,42 €	30°	875	334	143
280	16	113 16 280 6	511,82 €	30°	980	375	152
315	16	113 16 315 6	644,51 €	30°	1103	421	160
355	16	113 16 355 6	846,83 €	30°	1243	475	169
400	16	113 16 400 6	1.341,26 €	30°	1400	535	178
450	16	113 16 450 6	☎	30°	1575	602	
500	16	113 16 500 6	☎	30°	1750	669	

## U-PVC Geçme Mufllu Temiz Su Deve Boynu

### U-PVC Long Bend With O-Ring Socket

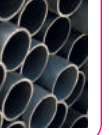

#### 45° PN 10

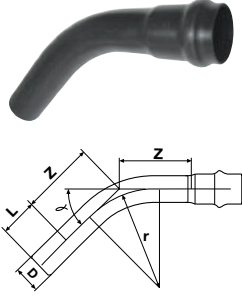

Çap Dia	Basınç PN	Kod Code	Fiyat (Adet) Price (Pcs)	Açı Angle	Yarıçap R	Z mm	L mm
<i>Emniyet kat sayısı (safety factor) C =2,5</i>							
50	10	114 10 050 6	3,69 €	45°	125	102	86
63	10	114 10 063 6	5,36 €	45°	221	117	90
75	10	114 10 075 6	9,07 €	45°	263	139	94
90	10	114 10 090 6	12,62 €	45°	315	166	97
<i>Emniyet kat sayısı (safety factor) C =2,0</i>							
110	10	114 10 110 6	16,69 €	45°	385	203	104
125	10	114 10 125 6	26,84 €	45°	438	231	108
140	10	114 10 140 6	36,31 €	45°	490	259	112
160	10	114 10 160 6	47,39 €	45°	560	296	119
200	10	114 10 200 6	94,79 €	45°	700	370	129
225	10	114 10 225 6	126,94 €	45°	788	416	136
250	10	114 10 250 6	180,78 €	45°	875	462	143
280	10	114 10 280 6	300,13 €	45°	980	518	152
315	10	114 10 315 6	379,42 €	45°	1103	583	160
355	10	114 10 355 6	518,19 €	45°	1243	656	169
400	10	114 10 400 6	789,36 €	45°	1400	740	178
450	10	114 10 450 6	☎	45°	1575	832	
500	10	114 10 500 6	☎	45°	1750	925	

#### 45° PN 16

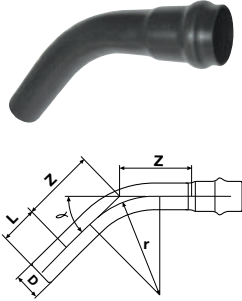

Çap Dia	Basınç PN	Kod Code	Fiyat (Adet) Price (Pcs)	Açı Angle	Yarıçap R	Z mm	L mm
<i>Emniyet kat sayısı (safety factor) C =2,5</i>							
50	16	114 16 050 6	5,65 €	45°	125	84	86
63	16	114 16 063 6	9,52 €	45°	221	84	90
75	16	114 16 075 6	15,43 €	45°	263	100	94
90	16	114 16 090 6	21,49 €	45°	315	120	97
<i>Emniyet kat sayısı (safety factor) C =2,0</i>							
110	16	114 16 110 6	28,31 €	45°	385	147	104
125	16	114 16 125 6	45,59 €	45°	438	167	108
140	16	114 16 140 6	61,81 €	45°	490	187	112
160	16	114 16 160 6	80,41 €	45°	560	214	119
200	16	114 16 200 6	160,78 €	45°	700	268	129
225	16	114 16 225 6	215,01 €	45°	788	301	136
250	16	114 16 250 6	306,42 €	45°	875	334	143
280	16	114 16 280 6	511,82 €	45°	980	375	152
315	16	114 16 315 6	644,51 €	45°	1103	421	160
355	16	114 16 355 6	846,83 €	45°	1243	475	169
400	16	114 16 400 6	1.341,26 €	45°	1400	535	178
450	16	114 16 450 6	☎	45°	1575	602	
500	16	114 16 500 6	☎	45°	1750	669	

**U-PVC Geçme Mufllu Temiz Su Deve Boynu**  
U-PVC Long Bend With O-Ring Socket

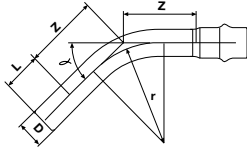

**60° PN 10**

Çap Dia	Basınç PN	Kod Code	Fiyat (Adet) Price (Pcs)	Açı Angle	Yarıçap R	Z mm	L mm
<i>Emniyet kat sayısı (safety factor) C =2,5</i>							
50	10	115 10 050 6	4,12 €	60°	125	122	86
63	10	115 10 063 6	6,17 €	60°	221	153	90
75	10	115 10 075 6	9,81 €	60°	263	182	94
90	10	115 10 090 6	17,33 €	60°	315	218	97
<i>Emniyet kat sayısı (safety factor) C =2,0</i>							
110	10	115 10 110 6	22,23 €	60°	385	266	104
125	10	115 10 125 6	35,42 €	60°	438	303	108
140	10	115 10 140 6	46,84 €	60°	490	339	112
160	10	115 10 160 6	64,26 €	60°	560	387	119
200	10	115 10 200 6	127,42 €	60°	700	484	129
225	10	115 10 225 6	180,77 €	60°	788	545	136
250	10	115 10 250 6	259,42 €	60°	875	605	143
280	10	115 10 280 6	348,48 €	60°	980	678	152
315	10	115 10 315 6	644,69 €	60°	1103	763	160
355	10	115 10 355 6	737,62 €	60°	1243	859	169
400	10	115 10 400 6	1.134,50 €	60°	1400	968	178
450	10	115 10 450 6	☎	60°	1575	1089	
500	10	115 10 500 6	☎	60°	1750	1210	

**60° PN 16**

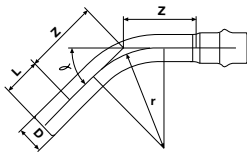

Çap Dia	Basınç PN	Kod Code	Fiyat (Adet) Price (Pcs)	Açı Angle	Yarıçap R	Z mm	L mm
<i>Emniyet kat sayısı (safety factor) C =2,5</i>							
50	16	115 16 050 6	6,08 €	60°	125	122	86
63	16	115 16 063 6	10,49 €	60°	221	153	90
75	16	115 16 075 6	16,69 €	60°	263	182	94
90	16	115 16 090 6	29,43 €	60°	315	218	97
<i>Emniyet kat sayısı (safety factor) C =2,0</i>							
110	16	115 16 110 6	37,82 €	60°	385	266	104
125	16	115 16 125 6	60,19 €	60°	438	303	108
140	16	115 16 140 6	79,63 €	60°	490	339	112
160	16	115 16 160 6	110,00 €	60°	560	387	119
200	16	115 16 200 6	215,62 €	60°	700	484	129
225	16	115 16 225 6	307,10 €	60°	788	545	136
250	16	115 16 250 6	439,47 €	60°	875	605	143
280	16	115 16 280 6	592,42 €	60°	980	678	152
315	16	115 16 315 6	1.095,78 €	60°	1103	763	160
355	16	115 16 355 6	1.258,40 €	60°	1243	859	169
400	16	115 16 400 6	1.928,26 €	60°	1400	968	178
450	16	115 16 450 6	☎	60°	1575	1089	
500	16	115 16 500 6	☎	60°	1750	1210	



## U-PVC Geçme Mufllu Temiz Su Deve Boynu

### U-PVC Long Bend With O-Ring Socket



#### 90° PN 10

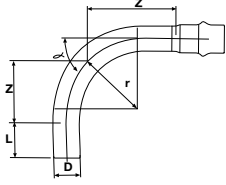

Çap Dia	Basınç PN	Kod Code	Fiyat (Adet) Price (Pcs)	Açı Angle	Yarıçap R	Z mm	L mm
<i>Emniyet kat sayısı (safety factor) C =2,5</i>							
50	10	116 10 050 6	4,12 €	90°	125	175	86
63	10	116 10 063 6	6,17 €	90°	221	246	90
75	10	116 10 075 6	9,81 €	90°	263	293	94
90	10	116 10 090 6	17,33 €	90°	315	351	97
<i>Emniyet kat sayısı (safety factor) C =2,0</i>							
110	10	116 10 110 6	22,23 €	90°	385	429	104
125	10	116 10 125 6	35,42 €	90°	438	488	108
140	10	116 10 140 6	46,84 €	90°	490	546	112
160	10	116 10 160 6	64,26 €	90°	560	624	119
200	10	116 10 200 6	127,42 €	90°	700	780	129
225	10	116 10 225 6	180,77 €	90°	788	878	136
250	10	116 10 250 6	259,42 €	90°	875	975	143
280	10	116 10 280 6	348,48 €	90°	980	1092	152
315	10	116 10 315 6	644,69 €	90°	1103	1229	160
355	10	116 10 355 6	737,62 €	90°	1243	1385	169
400	10	116 10 400 6	1.134,50 €	90°	1400	1560	178
450	10	116 10 450 6	☎	90°	1575	1755	
500	10	116 10 500 6	☎	90°	1750	1950	

#### 90° PN 16

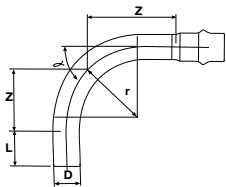

Çap Dia	Basınç PN	Kod Code	Fiyat (Adet) Price (Pcs)	Açı Angle	Yarıçap R	Z mm	L mm
<i>Emniyet kat sayısı (safety factor) C =2,5</i>							
50	16	116 16 050 6	6,08 €	90°	125	122	175
63	16	116 16 063 6	10,49 €	90°	221	153	246
75	16	116 16 075 6	16,69 €	90°	263	182	293
90	16	116 16 090 6	29,43 €	90°	315	218	351
<i>Emniyet kat sayısı (safety factor) C =2,0</i>							
110	16	116 16 110 6	37,82 €	90°	385	266	429
125	16	116 16 125 6	60,19 €	90°	438	303	488
140	16	116 16 140 6	79,63 €	90°	490	339	546
160	16	116 16 160 6	110,00 €	90°	560	387	624
200	16	116 16 200 6	215,62 €	90°	700	484	780
225	16	116 16 225 6	307,10 €	90°	788	545	878
250	16	116 16 250 6	439,47 €	90°	875	605	975
280	16	116 16 280 6	592,42 €	90°	980	678	1092
315	16	116 16 315 6	1.095,78 €	90°	1103	763	1229
355	16	116 16 355 6	1.258,40 €	90°	1243	859	1385
400	16	116 16 400 6	1.928,26 €	90°	1400	968	1560
450	16	116 16 450 6	☎	90°	1575	1089	1755
500	16	116 16 500 6	☎	90°	1750	1210	1950



## U-PVC Kayar Manşon PN 16

U-PVC Double Socketed Sleeve PN 16

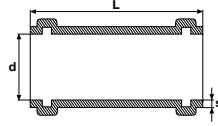

Çap Dia	Basınç PN	Kod Code	Fiyat (Adet) Price (Pcs)	Koli/ Adet Box/Pcs	Kg/Adet Kg/Pcs	S (mm)	L (mm)
*50	16	117 00 050 6	1,65 €	30	0,170	3,7	180
63	16	117 00 063 2	3,91 €	32	0,350	4,7	225
75	16	117 00 075 2	5,23 €	22	0,560	5,6	255
90	16	117 00 090 2	8,20 €	15	0,940	6,7	275
110	16	117 00 110 2	14,47 €	10	1,060	6,6	290
*125	16	117 00 125 6	14,59 €	7	1,670	7,4	290
*140	16	117 00 140 6	16,90 €	5	2,130	8,3	355
160	16	117 00 160 2	21,65 €	3	2,440	9,5	310
*200	16	117 00 200 5	39,49 €	2	4,100	11,9	338
*225	16	117 00 225 5	54,45 €	1	5,500	13,4	360
*250	16	117 00 250 5	77,33 €	1	7,230	14,8	385
*280	16	117 00 280 5	99,88 €	1		16,6	
*315	16	117 00 315 6	148,94 €	1	13,730	18,7	460
*355	16	117 00 355 2	209,44 €	1		21,1	
*400	16	117 00 400 6	299,64 €	1		23,7	

\*Konfeksiyon. / Hand-made from pipe  
Conta dahil değildir. / Gasket is not included the price.

## Boru Kelepçesi

Pipe Clamp

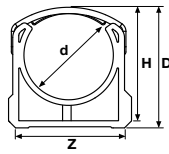

Çap Dia	Kod Code	Fiyat (Adet) Price (Pcs)	Koli/ Adet Box/Pcs	Kg/Adet Kg/Pcs	D (mm)	H (mm)	Z (mm)
20	118 00 020 4	0,08 €	500	0,004	31	29	15
25	118 00 025 4	0,09 €	400	0,006	35	30	16
32	118 00 032 4	0,14 €	300	0,007	49	40	14
40	118 00 040 4	0,16 €	200	0,016	54	46	19
50	118 00 050 4	0,22 €	100	0,022	67	66	18
63	118 00 063 4	0,46 €	200	0,029	91	101	25
75	118 00 075 4	0,58 €	100	0,035	93	101	23
90	118 00 090 4	0,89 €	100	0,122	136	138	25
110	118 00 110 4	0,91 €	100	0,062	135	126	23
125	118 00 125 4	1,42 €	100	0,114	159	159	25
160	118 00 160 4	2,44 €	50	0,240	197	207	30
200	118 00 200 4	3,33 €	30	0,320	240	235	30

## EPDM Temiz Su Borusu Üçgen Conta

### EPDM Rubber Triangle Gasket

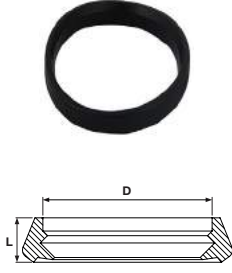

Çap Dia	Kod Code	Fiyat (Adet) Price (Pcs)	Koli/ Adet Box/Pcs	L (mm)
50	101 00 050 8	0,53 €		14
63	101 00 063 8	0,58 €	300	16,5
75	101 00 075 8	0,79 €	240	19,5
90	101 00 090 8	0,89 €	120	22
110	101 00 110 8	1,26 €	80	24
125	101 00 125 8	1,98 €	64	25
140	101 00 140 8	2,09 €	50	26
160	101 00 160 8	2,52 €	44	27
200	101 00 200 8	3,88 €	40	30,5
225	101 00 225 8	5,52 €	25	33
250	101 00 250 8	6,03 €	20	36
280	101 00 280 8	8,24 €	30	
315	101 00 315 8	12,08 €	40	
355	101 00 355 8	16,28 €	25	
400	101 00 400 8	22,05 €	25	
450	101 00 450 8	☎		
500	101 00 500 8	☎		

## EPDM Temiz Su Borusu Kare Conta

### EPDM Rubber Ring Gasket

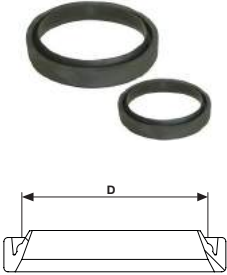

Çap Dia	Kod Code	Fiyat (Adet) Price (Pcs)	Koli/ Adet Box/Pcs
50	101 00 050 9	0,53 €	
63	101 00 063 9	0,58 €	300
75	101 00 075 9	0,79 €	240
90	101 00 090 9	0,89 €	120
110	101 00 110 9	1,26 €	80
125	101 00 125 9	1,98 €	64
140	101 00 140 9	2,09 €	50
160	101 00 160 9	2,52 €	44
200	101 00 200 9	3,88 €	40
225	101 00 225 9	5,52 €	25
250	101 00 250 9	6,03 €	20
280	101 00 280 9	8,24 €	30
315	101 00 315 9	12,08 €	40
355	101 00 355 9	16,28 €	25
400	101 00 400 9	22,05 €	25
450	101 00 450 9	☎	
500	101 00 500 9	☎	



### Somun Kelepçe ( Metal ) Metal Clamp With Nut



Çap Dia	Kod Code	Fiyat (Adet) Price (Pcs)	Koli/Adet Box/Pcs	Kg/Adet Kg/Pcs	Sıkma Aralığı	Çap (mm)	Askı Somunu	Saç (mm)	Bağlantı vidası
20	119 00 020 8	0,39 €	200	0,057	20-24	21	M8	1,5x20	M5
25	119 00 025 8	0,42 €	200	0,06	25-28	27	M8	1,5x20	M5
32	119 00 032 8	0,45 €	150	0,07	32-35	34	M8	1,5x20	M5
40	119 00 040 8	0,52 €	100	0,087	39-46	42	M8	1,5x20	M6
50	119 00 050 8	0,57 €	100	0,096	48-53	48	M8	1,5x20	M6
63	119 00 063 8	1,00 €	75	0,112	56-66	60	M10	1,5x20	M6
75	119 00 075 8	1,16 €	30	0,171	75-80	76	M10	2x25	M6
90	119 00 090 8	1,25 €	30	0,189	86-94	89	M10	2x25	M6
110	119 00 110 8	1,54 €	25	0,312	110-116	114	M10	2,5x25	M6
125	119 00 125 8	2,09 €	25	0,256	123-126	120	M10	2,5x25	M6
140	119 00 140 8	2,24 €	25	0,36	135-143	140	M10	2,5x25	M6
160	119 00 160 8	2,36 €	25	0,342	163-170	165	M10	2,5x25	M6
200	119 00 200 8	2,70 €	25	0,377	207-219	219	M10	2,5x25	M6

### Somunlu Ağır Yük Kelepçesi ( Metal ) Metal Clamp With Nut Heavy Load



Çap Dia	Kod Code	Fiyat (Adet) Price (Pcs)	Koli/Adet Box/Pcs	Kg/Adet Kg/Pcs	Sıkma Aralığı	Çap (mm)	Askı Somunu	Saç (mm)	Bağlantı vidası
20	119 01 020 8	1,47 €			20-23	21	M8	1,5x20	M5
25	119 01 025 8	1,47 €	50	1	25-28	27	M8	1,5x20	M5
32	119 01 032 8	1,50 €	50	1,5	32-35	34	M8	1,5x20	M5
40	119 01 040 8	1,56 €	50	1	40-45	42	M8	1,5x20	M6
50	119 01 050 8	1,69 €	50	0,28	48-58	48	M8	1,5x20	M6
63	119 01 063 8	1,85 €	40	0,39	56-60	60	M8	1,5x20	M6
75	119 01 075 8	2,00 €	25	0,35	75-80	76	M6	2x25	M6
90	119 01 090 8	2,17 €	25	0,39	86-91	89	M6	2x25	M6
110	119 01 110 8	2,66 €	25	0,45	110-115	114	M6	2,5x25	M6
125	119 01 125 8	4,16 €	10	0,65	123-126	120	M6	2,5x25	M6
140	119 01 140 8	4,36 €		0,75	138-142	140	M6	2,5x25	M6
160	119 01 160 8	4,65 €	10	1,1	160-165	165	M6	2,5x25	M6
200	119 01 200 8	☎		2,5	195-200	219	M6	2,5x25	M6

### Trifonlu Kelepçe

Metal Clamp With Screw



Çap Dia	Kod Code	Fiyat (Adet) Price (Pcs)	Koli/Adet Box/Pcs	Kg/Adet Kg/Pcs	Sıkma Aralığı	Çap (mm)	Askı Somunu	Saç (mm)	Bağlantı vidası
20	120 00 020 8	0,40 €	100	0,06	20-24	21	8x60	1,5x20	M5
25	120 00 025 8	0,43 €	100	0,066	25-28	27	8x60	1,5x20	M5
32	120 00 032 8	0,47 €	75	0,076	32-35	34	8x60	1,5x20	M5
40	120 00 040 8	0,52 €	50	0,082	39-46	42	8x60	1,5x20	M6
50	120 00 050 8	0,57 €	50	0,092	48-53	48	8x60	1,5x20	M6
63	120 00 063 8	0,90 €	50	0,103	56-66	60	8x60	1,5x20	M6
75	120 00 075 8	1,10 €	50	0,168	75-80	76	8x60	2x25	M6
90	120 00 090 8	1,25 €	25	0,182	86-94	89	8x60	2x25	M6
110	120 00 110 8	1,60 €	25	0,237	110-116	114	8x60	2,5x25	M6
125	120 00 125 8	2,00 €	25	0,265					M6
140	120 00 140 8	2,25 €	25	0,85					M6

### Uzun Trifonlu Kelepçe

Metal Clamp With Screw Long Bolt



Çap Dia	Kod Code	Fiyat (Adet) Price (Pcs)	Koli/Adet Box/Pcs	Kg/Adet Kg/Pcs	Sıkma Aralığı	Çap (mm)	Askı Somunu	Saç (mm)	Bağlantı vidası
20	120 01 020 8	0,31 €	150	0,07	20-24	21	8x60	1,5x20	M5
25	120 01 025 8	0,33 €	150	0,08	25-28	27	8x60	1,5x20	M5
32	120 01 032 8	0,36 €	100	0,09	32-35	34	8x60	1,5x20	M5
40	120 01 040 8	0,40 €	75	0,09	39-46	42	8x60	1,5x20	M6
50	120 01 050 8	0,47 €	75	0,09	48-53	48	8x60	1,5x20	M6
63	120 01 063 8	0,61 €	50	0,11	56-66	60	8x60	1,5x20	M6
75	120 01 075 8	0,86 €	30	0,12	75-80	76	8x60	2x25	M6
90	120 01 090 8	1,31 €	30	0,22	86-94	89	8x60	2x25	M6
110	120 01 110 8	1,36 €	25	0,23	110-116	114	8x60	2,5x25	M6

### Somunlu Ağır Yük Kelepçesi ( Kafalı )

Metal Clamp With Nut Heavy Load



Çap Dia	Kod Code	Fiyat (Adet) Price (Pcs)	Koli/Adet Box/Pcs	Kg/Adet Kg/Pcs	Sıkma Aralığı	Çap (mm)	Askı Somunu	Saç (mm)	Bağlantı vidası
50	119 02 050 8	1,35 €	50	0,28	48-58	48	M8	1,5x20	M6
63	119 02 063 8	1,45 €	40	0,39	56-60	60	M8	1,5x20	M6
75	119 02 075 8	1,58 €	25	0,2352	75-80	76	M10	2x25	M6
90	119 02 090 8	1,77 €	25	0,2364	86-91	89	M10	2x25	M6
110	119 02 110 8	2,19 €	25	0,236	110-115	114	M10	2,5x25	M6
125	119 02 125 8	3,03 €	10		123-126	120	M10	2,5x25	M6
140	119 02 140 8	☎	10	1,07	138-142	140	M10	2,5x25	M6
160	119 02 160 8	3,31 €	10	1,1	160-165	165	M10	2,5x25	M6
200	119 02 200 8	☎	5		195-200	219	M10	2,5x25	M6

**Sprinkler Kelepçe**  
Spirings Installation Clamp



Çap Dia	Kod Code	Fiyat (Adet) Price (Pcs)	Koli/Adet Box/Pcs	Kg/Adet Kg/Pcs	Sıkma Aralığı	Çap (mm)	Askı Somunu	Saç (mm)	Bağlantı vidası
25	119 03 025 8	0,26 €	100	0,06	25-28	27	M8	1,5x20	M5
32	119 03 032 8	0,29 €	100	0,07	32-35	34	M8	1,5x20	M5
40	119 03 040 8	0,33 €	100	0,08	40-45	42	M8	1,5x20	M6
50	119 03 050 8	0,35 €	75	0,09	48-58	48	M8	1,5x20	M6
63	119 03 063 8	0,37 €	50	0,1	56-60	60	M8	1,5x20	M6
75	119 03 075 8	0,58 €	50	0,11	75-80	76	M10	2x25	M6
90	119 03 090 8	0,66 €	50	0,15	86-91	89	M10	2x25	M6
110	119 03 110 8	0,77 €	25	0,21	110-115	114	M10	2,5x25	M6
140	119 03 140 8	1,17 €	25	0,23	138-142	140	M10	2,5x25	M6
160	119 03 160 8	1,31 €	25	0,45	160-165	165	M10	2,5x25	M6

**U Bolt**  
U Bolt



Çap Dia	Kod Code	Fiyat (Adet) Price (Pcs)	Koli/Adet Box/Pcs	Kg/Adet Kg/Pcs	d	L	Açma Aralığı
1/2"	119 04 020 8	0,52 €	100	0,02	M-6		24
3/4"	119 04 025 8	0,58 €	100	0,02	M-6		30
1"	119 04 032 8	0,75 €	100	0,05	M-8		36
1 1/4"	119 04 040 8	0,92 €	70	0,05	M-8		46
1 1/2"	119 04 050 8	1,04 €	50	0,06	M-8		52
2"	119 04 063 8	1,44 €	50	0,12	M-10		64
2 1/2"	119 04 075 8	1,67 €	30	0,14	M-10		78
3"	119 04 090 8	2,59 €	25	0,25	M-12		94
4"	119 04 110 8	3,45 €	25	0,28	M-12		118
5"	119 04 140 8	3,85 €	10	0,35	M-12		146
6"	119 04 160 8	8,86 €	10	0,71	M-16		172
8"	119 04 225 8	9,20 €	10	0,95	M-16		224
10"	119 04 280 8	13,80 €	5	1,20	M-16		278
12"	119 04 315 8	17,25 €	5	1,60	M-16		328

**C Kanal**  
Canal C



Kod Code	Fiyat (Adet) Price (Pcs)	a (mm)	b (mm)	m (mm)	L (mm)	Uzunluk Length
119 00 001 8	12,08 €	27	18	1,25	2000	2000
119 00 002 8	17,83 €	28	30	1,75	2000	2000
119 00 003 8	31,05 €	38	40	2,00	2000	2000

**U Kanal**  
Canal U



Kod Code	Fiyat (Adet) Price (Pcs)	a (mm)	b (mm)	m (mm)	L (mm)	Uzunluk Length
119 00 004 8	22,43 €	30	30	3	2000	2000
119 00 005 8	31,63 €	40	40	3	2000	2000
119 00 006 8	40,25 €	40	40	4	2000	2000
119 00 007 8	50,60 €	50	40	4	2000	2000

**L Kanal**  
Canal L



Kod Code	Fiyat (Adet) Price (Pcs)	a (mm)	b (mm)	m (mm)	L (mm)	Uzunluk Length
119 00 008 8	15,53 €	30	30	3	2000	2000
119 00 009 8	21,28 €	40	40	3	2000	2000
119 00 010 8	25,88 €	40	40	4	2000	2000
119 00 011 8	35,08 €	50	50	4	2000	2000

### Boru Gömleklİ Dübel

Sleeve Pipe Anchor



Çap Dia	Kod Code	Fiyat (Adet) Price (Pcs)	Koli/Adet Box/Pcs	D	d	L
M-6	119 00 024 8	0,48 €	100	10	6	65
M-8	119 00 025 8	1,10 €	100	13	8	65
M-10	119 00 026 8	1,50 €	100	15	10	85
M-12	119 00 027 8	1,50 €	100	16	12	90

### Çakmalı Dübel

Drop-In Anchor



Çap Dia	Kod Code	Fiyat (Adet) Price (Pcs)	Koli/Adet Box/Pcs	D (mm)	d (mm)	L (mm)
M-6	119 00 012 8	0,35 €	100	8	6	30
M-8	119 00 013 8	0,38 €	100	10	8	35
M-10	119 00 014 8	0,53 €	100	12	10	40
M-12	119 00 015 8	0,94 €	100	15	12	50

### Çekmeceli Dübel

Cavity Anchor



Çap Dia	Kod Code	Fiyat (Adet) Price (Pcs)	Koli/Adet Box/Pcs	D (mm)	d (mm)	L (mm)
M-6	119 00 016 8	0,58 €	100	10	6	30
M-8	119 00 017 8	0,58 €	100	13	8	35
M-10	119 00 018 8	0,92 €	100	15	10	45
M-12	119 00 019 8	1,38 €	100	17	12	50

### Saç Gömleklİ Dübel

Sleeve Sheet Anchor



Çap Dia	Kod Code	Fiyat (Adet) Price (Pcs)	Koli/Adet Box/Pcs	D (mm)	d (mm)	L (mm)
M-6	119 00 020 8	0,25 €	100	8	6	65
M-8	119 00 021 8	0,44 €	100	10	8	65
M-10	119 00 022 8	0,74 €	100	12	10	85
M-12	119 00 023 8	1,50 €	100	16	12	90

### Gijon (Galvanizli)

Gijon (Galvenise)



Çap Dia	Kod Code	Fiyat (Adet) Price (Pcs)	Uzunluk Length
M6 x 1000	119 00 112 8	1,41 €	1000
M8 x 1000	119 00 111 3	2,10 €	1000
M10 x 1000	119 00 111 4	3,33 €	1000
M12 x 1000	119 00 111 5	4,83 €	1000
M16 x 1000	119 00 111 6	10,92 €	1000



**Boru Kelepçesi Alt/Yan Destekli**  
*Pipe Clamp*

**NEW**

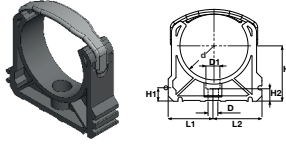

d Dia	Kod Code	Fiyat (Adet) Price (Pcs)	D mm	D1 mm	L1 mm	L2 mm	H mm	H1 mm	H2 mm	H3 mm	S
20	S000 00 20	☎	6	11	17	19	25	10	6	16	M5
25	S000 00 25	☎	6	11	19	22	28	10	6	16	M5
32	S000 00 32	☎	6	11	24	27	31	10	6	16	M5
40	S000 00 40	☎	7	14	34	34	35	10	7	22	M6
50	S000 00 50	☎	7	14	37	37	40	10	7	22	M6
63	S000 00 63	☎	9	17	45	45	52	10	10	25	M8
75	S000 00 75	☎	9	17	52	52	58	10	10	25	M8
90	S000 00 90	☎	9	17	65	65	65	10	10	28	M8
110	S000 00 110	☎	9	17	79	79	75	10	10	28	M8
125	S000 00 125	☎	9	17	88	88	90	10	10	32	M8
140	S000 00 140	☎	9	17	98	98	110	10	10	32	M8
160	S000 00 160	☎	9	17	109	109	108	10	10	32	M8

**Boru Kelepçesi Alt/Yan Destek Parçası**  
*Pipe Clamp*

**NEW**

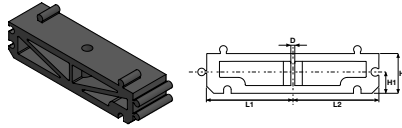

d Dia	Kod Code	Fiyat (Adet) Price (Pcs)	D mm	L1 mm	L2 mm	H mm	H1 mm	S
20	S100 00 20	☎	6	17	19	20	10	M5
25	S100 00 25	☎	6	19	22	20	10	M5
32	S100 00 32	☎	6	24	27	20	10	M5
40	S100 00 40	☎	7	34	34	20	10	M6
50	S100 00 50	☎	7	37	37	20	10	M6
63	S100 00 63	☎	9	45	45	20	10	M8
75	S100 00 75	☎	9	52	52	20	10	M8
90	S100 00 90	☎	9	65	65	20	10	M8
110	S100 00 110	☎	9	79	79	20	10	M8
125	S100 00 125	☎	9	88	88	20	10	M8
140	S100 00 140	☎	9	98	98	20	10	M8
160	S100 00 160	☎	9	109	109	20	10	M8





## TEKNİK MALZEMELER TECHNICAL MATERIALS



### PVC-U Yapıştırıcı 1000 Gr PVC-U Solvent 1000 Gr



ML / L	Kod Code	Fiyat (Adet) Price (Pcs)	Koli /Adet Box/Pcs
1000	13 01 10 00 8	20,00 €	8
500	13 01 05 00 8	12,00 €	12
250	13 01 02 50 8	7,00 €	24

### PVC-U Temizleyici PVC-U Cleaner 1000 Gr



Kg	Kod Code	Fiyat (Adet) Price (Pcs)	Koli /Adet Box/Pcs
1000	13 10 0100 8	19,50 €	12

### U-PVC Boruların Birbirine Eklenmesi Connection Of U-PVC Pipes



1) Öncelikle birbirine yapıştırılacak olan parçaların yapıştırma bölgeleri temizleyici sıvı kullanılarak bütün toz, yağ, pislik ve çapaklardan temizlenir.

1) First of all the glueing parts have to be clean by cleanser liquid for purge the parts from dust, oil and bur.



3) Yapıştırılacak olan her iki parça üzerinde yapıştırma bölgeleri uygun bir şekilde zımparalanır. Zımparalama işleminden sonra tekrar temizleme sıvısı ile yapıştırma bölgeleri temizlenir ve kurulanır.

3) On both of two parts, glueing area have to rubbing with sandpaper. After rubbing pro-cess glueing areas have to be clean by cleanser liquid and to be dry.



5) Yapıştırıcı uygun bir şekilde sürüldükten sonra parçalar hiç beklemeden hızlı bir şekilde ve döndürülmeden birbiri içine itilir.

5) After correct application of glue, parts must pushing each other as nonstop, straightly and very quickly.



2) Yapıştırma alanı muf boyuna göre işaretlenir.

2) Glueing area has to marked according to solvent cement socket connection length.



4) Yapıştırılacak olan her iki parça üzerine temiz bir fırça ile boylamasına olarak yapıştırıcı sürülür. Parçalar üzerine gereğinden fazla yapıştırıcı sürüldüyse bu fazla sürülen yapıştırıcı kutusuna geri alınır.

4) Pimtaş Solvent Cement has to apply on two glueing areas with a clear brush as longitudinal. In case of pouring, excess glue should be taken back into the glue can.



6) Parçalar birbiri içine itilince dışarı taşan fazla yapıştırıcı temizlenir.

6) Later on pushed parts to inside each other and came off over glue should be cleaning.

### U-PVC Plaka (Koyu Gri)

U-PVC Plate (Dark Grey)



Çap Dia	Kod Code	Fiyat (Adet) Price (Pcs)	Plaka Ölçüsü Plate Dia 2000x1000 kg	Plaka Ölçüsü Plate Dia 3000x1500 kg
3	127 00 003 3	10,00 €	8,64	19,44
4	127 00 004 3	10,00 €	11,52	25,92
5	127 00 005 3	10,00 €	14,40	32,40
6	127 00 006 3	10,00 €	17,28	38,88
7	127 00 007 3	10,00 €	20,16	45,36
8	127 00 008 3	10,00 €	23,04	51,84
10	127 00 010 3	10,00 €	28,80	64,80
12	127 00 012 3	10,00 €	34,56	77,76
15	127 00 015 3	10,00 €	43,20	97,20
20	127 00 020 3	10,00 €	57,60	129,60
25	127 00 025 3	10,00 €	72,00	162,00
30	127 00 030 3	10,00 €	86,40	194,40



### PP Plaka (Bej)

PP Plate (Beige)



Çap Dia	Kod Code	Fiyat (Adet) Price (Pcs)	Plaka Ölçüsü Plate Dia 2000x1000 kg	Plaka Ölçüsü Plate Dia 3000x1500 kg
3	127 01 003 3	10,00 €	5,55	12,56
4	127 01 004 3	10,00 €	7,42	16,74
5	127 01 005 3	10,00 €	9,29	20,93
6	127 01 006 3	10,00 €	11,09	25,11
7	127 01 007 3	10,00 €		
8	127 01 008 3	10,00 €	14,88	33,48
10	127 01 010 3	10,00 €	18,61	41,85
12	127 01 012 3	10,00 €	22,32	50,22
15	127 01 015 3	10,00 €	27,91	62,78
20	127 01 020 3	10,00 €	37,19	83,72
25	127 01 025 3	10,00 €	46,49	104,47
30	127 01 030 3	10,00 €	55,81	125,56

### HDPE Plaka (Siyah)

HDPE Plate (Black)



Çap Dia	Kod Code	Fiyat (Adet) Price (Pcs)	Plaka Ölçüsü Plate Dia 2000x1000 kg	Plaka Ölçüsü Plate Dia 3000x1500 kg
3	127 02 003 3	10,00 €	5,76	12,96
4	127 02 004 3	10,00 €	7,65	17,28
5	127 02 005 3	10,00 €	9,62	21,62
6	127 02 006 3	10,00 €	11,52	25,93
7	127 02 007 3	10,00 €		
8	127 02 008 3	10,00 €	15,36	34,56
10	127 02 010 3	10,00 €	19,21	43,22
12	127 02 012 3	10,00 €	23,04	51,88
15	127 02 015 3	10,00 €	28,81	64,83
20	127 02 020 3	10,00 €	38,41	86,45
25	127 02 025 3	10,00 €	48,01	108,01
30	127 02 030 3	10,00 €	57,61	129,65

**U-PVC İçi Dolu Kütük**  
U-PVC Solid Rod



Çap Dia	Kod Code	Fiyat (Kg) Price (Kg)	Kg/m
10	126 00 010 3	12,00 €	0,110
12	126 00 012 3	12,00 €	0,180
15	126 00 015 3	12,00 €	0,275
16	126 00 016 3	12,00 €	0,300
18	126 00 018 3	12,00 €	0,378
20	126 00 020 3	12,00 €	0,500
22	126 00 022 3	12,00 €	0,600
25	126 00 025 3	12,00 €	0,750
28	126 00 028 3	12,00 €	0,900
30	126 00 030 3	12,00 €	1,050
32	126 00 032 3	12,00 €	1,170
35	126 00 035 3	12,00 €	1,350
36	126 00 036 3	12,00 €	1,500
40	126 00 040 3	12,00 €	1,900
45	126 00 045 3	12,00 €	2,400
50	126 00 050 3	12,00 €	2,900
55	126 00 055 3	12,00 €	3,500
60	126 00 060 3	12,00 €	4,200

\* Kütük Uzunluğu 2 m/adet  
Solid Rod Length 2 m/pcs

**PP İçi Dolu Kütük (Bej)**  
PP Solid Rod (Beige)



Çap Dia	Kod Code	Fiyat (Kg) Price (Kg)	Kg/m
10	126 01 010 3	15,00 €	0,078
12	126 01 012 3	15,00 €	0,114
15	126 01 015 3	15,00 €	0,176
16	126 01 016 3	15,00 €	0,195
18	126 01 018 3	15,00 €	
20	126 01 020 3	15,00 €	0,312
22	126 01 022 3	15,00 €	
25	126 01 025 3	15,00 €	0,484
28	126 01 028 3	15,00 €	
30	126 01 030 3	15,00 €	0,694
32	126 01 032 3	15,00 €	0,767
35	126 01 035 3	15,00 €	0,947
36	126 01 036 3	15,00 €	
40	126 01 040 3	15,00 €	1,230
45	126 01 045 3	15,00 €	1,560
50	126 01 050 3	15,00 €	1,950
55	126 01 055 3	15,00 €	2,300
60	126 01 060 3	15,00 €	2,800

\* Kütük Uzunluğu 2 m/adet  
Solid Rod Length 2 m/pcs

**HDPE İçi Dolu Kütük (Siyah)**  
HDPE Solid Rod (Black)



Çap Dia	Kod Code	Fiyat (Kg) Price (Kg)	Kg/m
10	126 02 010 3	15,00 €	
12	126 02 012 3	15,00 €	
15	126 02 015 3	15,00 €	
16	126 02 016 3	15,00 €	
18	126 02 018 3	15,00 €	
20	126 02 020 3	15,00 €	
22	126 02 022 3	15,00 €	
25	126 02 025 3	15,00 €	
28	126 02 028 3	15,00 €	
30	126 02 030 3	15,00 €	
32	126 02 032 3	15,00 €	
35	126 02 035 3	15,00 €	
36	126 02 036 3	15,00 €	
40	126 02 040 3	15,00 €	
45	126 02 045 3	15,00 €	
50	126 02 050 3	15,00 €	
55	126 02 055 3	15,00 €	
60	126 02 060 3	15,00 €	

\* Kütük Uzunluğu 2 m/adet  
Solid Rod Length 2 m/pcs

## Sıcak Hava Kaynak Makinesi ve Aksesuarları

### Hot Air Welding Machine and Accessories



Kod Code	Fiyat (Adet) Price (Pcs)	Parça Adı Description Of Item
128 00 1500 8	820,00 €	Elektronik el kaynak makinesi Electronic hot air welding machine
128 02 4000 8	70,88 €	Ağızlık 5 mm yuvarlak Round nozzle, 5 mm
128 03 4002 8	70,88 €	Ağızlık 5 mm düz Nozzle, 5 mm flat
128 04 4003 8	85,05 €	Ağızlık 40 mm düz Nozzle, 40 mm flat
128 05 5010 8	90,83 €	3 mm yuvarlak hızlı kaynak ağızlığı Speed welding nozzle, 3 mm round
128 06 5011 8	90,83 €	4 mm yuvarlak hızlı kaynak ağızlığı Speed welding nozzle, 4 mm round
128 07 5012 8	90,83 €	5 mm yuvarlak hızlı kaynak ağızlığı Speed welding nozzle, 5 mm round
128 08 5015 8	43,53 €	Kuntra ağızlık Tacking tip item
128 09 7001 8	85,05 €	45 mm Basınç tekeri (1 asklı) Pressure roller one-armed 45 mm

#### TEKNİK ÖZELLİKLER

Tip: Elektronik

Voltaj: 230 V. 50/60 Hz veya 1300 W. 120V

Isıtma kapasitesi: 1500 W. 230 V. veya 1300 W. 120 V Sıcaklık: 20-700 °C. sınırsız değişken

Ölçüleri: Uzunluk 320 mm. tutamak kolu çapı 52 mm

Elektrik Sigortası : Çift izole

#### TECHNICAL SPECIFICATIONS

Model: Electronice

Voltage: 230 V 50/60 Hz oder 120 V 50/60 Hz Heat output: 1500 W 230 V oder 120 V

Dimensions: Length 320 mm. handle diameter 52 mm Electrical safety: Double insulated

## U-PVC Kaynak Çubuğu

### U-PVC Welding Rods



Çap Dia	Kod Code	Fiyat (Adet) Price (Pcs)	Kg /Koli Kg/Box
3	123 00 003 1	11,00 €	2
4	123 00 004 1	11,00 €	2
5	123 00 005 1	11,00 €	2
6	123 00 006 1	11,00 €	2
7	123 00 007 1	11,00 €	2
8	123 00 008 1	11,00 €	2
9	123 00 009 1	11,00 €	2
10	123 00 010 1	11,00 €	2
12	123 00 012 1	11,00 €	2

## PE Kaynak Çubuğu

### PE Welding Rods



Çap Dia	Kod Code	Fiyat (Adet) Price (Pcs)	Kg /Koli Kg/Box
3	124 00 003 1	12,00 €	5
4	124 00 004 1	12,00 €	5

## PP Kaynak Çubuğu

### PP Welding Rods



Çap Dia	Kod Code	Fiyat (Adet) Price (Pcs)	Kg /Koli Kg/Box
3	125 00 003 1	12,00 €	5
4	125 00 004 1	12,00 €	5
3	125 00 003 1	12,00 €	5
4	124 00 004 1	12,00 €	5





**UH-PVC**

**EK PARÇALAR / FITTINGS**

**ÜRETİM STANDARDI / PRODUCTION STANDARD**

**EN 1452-3**

**ÇAP / SIZE Ø20 - Ø400**

**UH-PVC Yapıştırma Mufu 90° Dirsek**  
UH-PVC Solvent Cement 90° Elbow

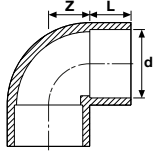

d	Basınç PN	Kod Code	Fiyat (Adet) Price (Pcs)	Kg /Adet Kg/Pcs	Koli/Adet Box/Pcs	DN	L (mm)	Z (mm)
20	16	500 00 020 2	0,23 €	0,01	300	15	16	11
25	16	500 00 025 2	0,28 €	0,02	200	20	18,5	13,5
32	16	500 00 032 2	0,42 €	0,02	100	25	22	17
40	16	500 00 040 2	0,77 €	0,05	60	32	26	21
50	16	500 00 050 2	0,78 €	0,09	80	40	31	26
63	16	500 00 063 2	0,98 €	0,18	60	50	38	32,5
75	16	500 00 075 2	1,88 €	0,31	40	65	43,5	38,5
90	16	500 00 090 2	2,60 €	0,42	25	80	51	46
110	16	500 00 110 2	4,40 €	0,75	15	100	61	56
125	16	500 00 125 2	6,55 €	1,15	8	110	68,5	63,5
140	16	500 00 140 2	9,70 €	1,53	6	125	76	71
160	16	500 00 160 2	12,55 €	2,25	4	150	86	81
200	10	500 00 200 2	30,55 €	4,65	2	175	106	101
225	10	500 00 225 2	44,50 €	4,83	1	200	118,5	114
250	10	500 00 250 4	112,00 €	6,97	1	250	131	131
280	10	500 00 280 4	175,00 €	8,55	1	250	146	141
315	10	500 00 315 4	198,00 €	12,3	1	300	163,5	163
355	10	500 00 355 4	310,00 €	17,5	1	350	183,5	184
400	10	500 00 400 4	375,00 €	23,5	1	400	206	206

**UH-PVC 90° Tek Tarafı İçten Dişli Dirsek**  
UH-PVC 90° One Side Female Threaded Elbow

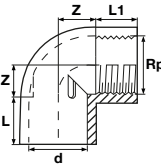

d-Rp Inch	Basınç PN	Kod Code	Fiyat (Adet) Price (Pcs)	Kg /Adet Kg/Pcs	Koli/Adet Box/Pcs	DN	Z (mm)	L (mm)	L1 (mm)
20 x 1/2"	16	500 10 020 2	0,65 €	0,02	303	15	11	16	14
25 x 3/4"	16	500 10 025 2	0,78 €	0,02	200	20	14	18,5	15,5
32 x 1"	16	500 10 032 2	0,94 €	0,04	100	25	17	22	21
40 x 1 1/4"	16	500 10 040 2	1,53 €	0,05	60	32	21	26	23
50 x 1 1/2"	16	500 10 050 2	1,95 €	0,09	80	40	26	31	25
63 x 2"	16	500 10 063 2	2,74 €	0,19	60	50	33	38	29,5
75 x 2 1/2"	16	500 10 075 2	5,64 €	0,41	40	65	38,5	43,5	30
90 x 3"	16	500 10 090 2	7,80 €	0,51	25	80	46	51	33
110 x 4"	16	500 10 110 2	13,20 €	1,00	15	100	56	61	39

**UH-PVC 90° Çift Tarafı İçten Dişli Dirsek**  
UH-PVC 90° Both Sides Female Threaded Elbow

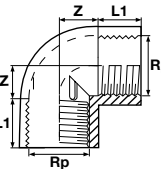

Rp Inch	Basınç PN	Kod Code	Fiyat (Adet) Price (Pcs)	Kg /Adet Kg/Pcs	Koli/Adet Box/Pcs	DN	L1 (mm)	Z (mm)
1/2"	16	500 20 020 2	0,75 €	0,02	303	15	14	11
3/4"	16	500 20 025 2	0,90 €	0,02	200	20	16,5	14
1"	16	500 20 032 2	1,08 €	0,04	100	25	21	17
1 1/4"	16	500 20 040 2	1,76 €	0,05	60	32	23	21
1 1/2"	16	500 20 050 2	2,24 €	0,09	80	40	25	26
2"	16	500 20 063 2	3,15 €	0,19	60	50	29,5	33
2 1/2"	16	500 20 075 2	6,50 €	0,42	40	65	30	38,5
3"	16	500 20 090 2	9,00 €	0,55	25	80	33	46
4"	16	500 20 110 2	15,00 €	1,05	15	100	39	56



### UH-PVC Yapıştırma Mufllu Redüksiyonlu 90° Dirsek

UH-PVC PRO-FIT Elbow 90°

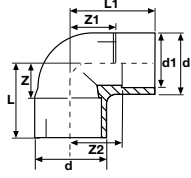

d (mm)	d1 (mm)	Basınç PN	Kod Code	Fiyat (Adet) Price (Pcs)	Kg /Adet Kg/Pcs	Koli/Adet Box/Pcs	L (mm)	L1 (mm)	Z (mm)	Z1 (mm)	Z2 (mm)
50	40	16	501 00 050040 2	2,19 €	0,12	80	57	67	26	36	41
63	50	16	501 00 063050 2	2,26 €	0,23	40	71	83	33	45	52

### UH-PVC Redüksiyonlu Dış Dış 90° Dirsek

UH-PVC PRO-FIT Male Threaded Elbow 90°

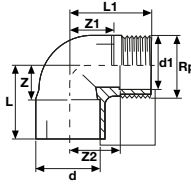

d (mm)	Rp (Inch)	Basınç PN	Kod Code	Fiyat (Adet) Price (Pcs)	Kg /Adet Kg/Pcs	Koli/Adet Box/Pcs	d1 (mm)	L (mm)	L1 (mm)	Z (mm)	Z1 (mm)	Z2 (mm)
50	1 1/2"	10	501 10 050040 2	2,77 €	1,00	80	40	57	67	26	36	41
63	2"	10	501 10 063050 2	3,92 €	1,00	40	50	71	83	33	45	52

### UH-PVC 90° Deve Boynu Dirsek (İç Dış Yapıştırma)

UH-PVC 90° Short Bend

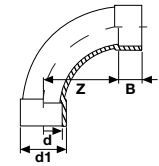

d (mm)	Basınç PN	Kod Code	Fiyat (Adet) Price (Pcs)	Kg /Adet Kg/Pcs	Koli/Adet Box/Pcs	d1 (mm)	Z (mm)	B (mm)
50	16	501 00 050050 2	6,63 €	0,27	25	63	100	31
63	16	501 00 063063 2	8,30 €	0,51	20	75	126	38
75	16	501 00 075075 2	16,05 €	0,78	15	90	150	44
90	16	501 00 090090 2	23,50 €	1,33	10	110	180	51
110	16	501 00 110110 2	37,40 €	2,96	5	125	220	61



**UH-PVC 45° Yapıştırma Mumlu Dirsek**  
UH-PVC 45° Solvent Cement Elbow

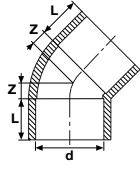

d (mm)	Basınç PN	Kod Code	Fiyat (Adet) Price (Pcs)	Kg /Adet Kg/Pcs	Koli/Adet Box/Pcs	DN (mm)	L (mm)	Z (mm)
20	16	502 00 020 2	0,23 €	0,01	400	15	16	5
25	16	502 00 025 2	0,27 €	0,01	200	20	18,5	6
32	16	502 00 032 2	0,41 €	0,02	100	25	22	7,5
40	16	502 00 040 2	0,72 €	0,04	75	32	26	9,5
50	16	502 00 050 2	0,75 €	0,07	80	40	31	11,5
63	16	502 00 063 2	0,89 €	0,13	50	50	38	14
75	16	502 00 075 2	1,79 €	0,20	40	65	43,5	16,5
90	16	502 00 090 2	2,42 €	0,34	25	80	51	19,5
110	16	502 00 110 2	4,25 €	0,63	18	100	61	24
125	16	502 00 125 2	6,25 €	0,91	8	110	68,5	27
140	16	502 00 140 2	8,95 €	1,35	6	125	76	30
160	16	502 00 160 2	12,50 €	2,00	5	150	86	34
200	10	502 00 200 2	26,80 €	3,7	2	175	106	43
225	10	502 00 225 2	44,00 €	4	2	200	118,5	48
250	10	502 00 250 4	96,00 €	5,47	2	250	131	53
280	10	502 00 280 5	160,00 €	7,51	1	250	146	59
315	10	502 00 315 4	171,00 €	9,2	1	300	163,5	63
355	10	502 00 355 5	280,00 €	9,65	1	350	183,5	67
400	10	502 00 400 4	350,00 €	5	1	400	206	72

**UH-PVC 45° Tek Tarafı İçten Dişli Dirsek**  
UH-PVC 45° One Side Female Threaded Elbow

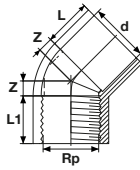

d-Rp Inch	Basınç PN	Kod Code	Fiyat (Adet) Price (Pcs)	Kg /Adet Kg/Pcs	Koli/Adet Box/Pcs	DN (mm)	L (mm)	L1 (mm)	Z (mm)
20 x 1/2"	16	502 10 020 2	0,65 €	0,02	300	15	16	14	5
25 x 3/4"	16	502 10 025 2	0,78 €	0,02	200	20	18,5	16,5	6
32 x 1"	16	502 10 032 2	0,94 €	0,03	100	25	22	21	7,5
40 x 1 1/4"	16	502 10 040 2	1,53 €	0,04	60	32	26	23	9,5
50 x 1 1/2"	16	502 10 050 2	1,95 €	0,08	80	40	31	25	11,5
63 x 2"	16	502 10 063 2	2,74 €	0,14	60	50	38	29,5	14
75 x 2 1/2"	16	502 10 075 2	5,64 €	0,30	40	63	43,5	30	16,5
90 x 3"	16	502 10 090 2	7,80 €	0,43	25	80	51	33	19,5
110 x 4"	16	502 10 110 2	13,20 €	0,88	18	100	61	39	24

**UH-PVC 45° Çift Tarafı İçten Dişli Dirsek**  
UH-PVC 45° Both Sides Female Threaded Elbow

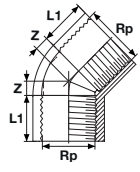

Rp Inch	Basınç PN	Kod Code	Fiyat (Adet) Price (Pcs)	Kg /Adet Kg/Pcs	Koli/Adet Box/Pcs	DN (mm)	L1 (mm)	Z (mm)
1/2"	16	502 20 020 2	0,75 €	0,02	300	15	14	5
3/4"	16	502 20 025 2	0,90 €	0,02	200	20	16,5	6
1"	16	502 20 032 2	1,08 €	0,03	100	25	21	7,5
1 1/4"	16	502 20 040 2	1,76 €	0,04	60	32	23	9,5
1 1/2"	16	502 20 050 2	2,24 €	0,09	80	40	25	11,5
2"	16	502 20 063 2	3,15 €	0,15	60	50	29,5	14
2 1/2"	16	502 20 075 2	6,50 €	0,32	40	63	30	16,5
3"	16	502 20 090 2	9,00 €	0,45	25	80	33	19,5
4"	16	502 20 110 2	15,00 €	0,87	18	100	39	24

### UH-PVC Yapıştırma Mufllu Te

#### UH-PVC Solvent Cement Tee

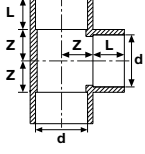

d (mm)	Basınc PN	Kod Code	Fiyat (Adet) Price (Pcs)	Kg /Adet Kg/Pcs	Koli/Adet Box/Pcs	DN	L (mm)	Z (mm)
20	16	504 00 020 2	0,28 €	0,02	200	15	16	11
25	16	504 00 025 2	0,32 €	0,04	100	20	18,5	13,5
32	16	504 00 032 2	0,65 €	0,07	60	25	22	17
40	16	504 00 040 2	0,87 €	0,11	90	32	26	21
50	16	504 00 050 2	0,89 €	0,12	50	40	31	26
63	16	504 00 063 2	1,25 €	0,22	50	50	38	32,5
75	16	504 00 075 2	2,20 €	0,33	30	65	43,5	38,5
90	16	504 00 090 2	3,40 €	0,60	18	80	51	46
110	16	504 00 110 2	5,35 €	1,05	10	100	61	56
125	16	504 00 125 2	8,05 €	2,09	6	110	68,5	63,5
140	16	504 00 140 2	13,00 €	2,18	4	125	76	71
160	16	504 00 160 2	17,90 €	3,30	3	150	86	81
200	10	504 00 200 2	32,00 €	4,57	1	175	106	101
225	10	504 00 225 2	60,00 €	6,50	1	200	118,5	114
250	10	504 00 250 4	124,00 €	8,92	1	250	131	126
280	10	504 00 280 4	190,00 €	11,3	1	250	146	141
315	10	504 00 315 4	220,50 €	16,4	1	300	163,5	159
355	10	504 00 355 4	360,00 €	23,6	1	350	183,5	184
400	10	504 00 400 4	490,00 €	28,1	1	400	206	206



### UH-PVC Tek Taraf İçten Dişli Te

#### UH-PVC One Side Female Threaded Tee

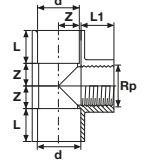

d (mm)	Rp (Inch)	Basınc PN	Kod Code	Fiyat (Adet) Price (Pcs)	Kg /Adet Kg/Pcs	Koli/Adet Box/Pcs	DN (mm)	L1 (mm)	L (mm)	Z (mm)
20	1/2"	16	504 10 020 2	0,87 €	0,02	200	15	14	16	11
25	3/4"	16	504 10 025 2	0,97 €	0,04	100	20	16,5	18,5	14
32	1"	16	504 10 032 2	1,15 €	0,07	60	25	21	22	18
40	1 1/4"	16	504 10 040 2	1,80 €	0,11	90	32	23	26	21
50	1 1/2"	16	504 10 050 2	2,40 €	0,12	50	40	25	31	26
63	2"	16	504 10 063 2	3,38 €	0,22	50	50	29,5	38	32,5
75	2 1/2"	16	504 10 075 2	6,60 €	0,22	30	65	30	43,5	40
90	3"	16	504 10 090 2	10,20 €	0,22	18	80	33	51	46
110	4"	16	504 10 110 2	16,05 €	0,22	10	100	39	61	52

### UH-PVC İçten Dişli Te

#### UH-PVC Female Threaded Tee

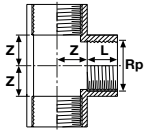

Rp (Inch)	Basınc PN	Kod Code	Fiyat (Adet) Price (Pcs)	Kg /Adet Kg/Pcs	Koli/Adet Box/Pcs	DN (mm)	L (mm)	Z (mm)
1/2"	16	504 20 020 2	1,00 €	0,02	200	15	14	11
3/4"	16	504 20 025 2	1,12 €	0,04	100	20	16,5	14
1"	16	504 20 032 2	1,32 €	0,07	60	25	21	18
1 1/4"	16	504 20 040 2	2,07 €	0,11	90	32	23	21
1 1/2"	16	504 20 050 2	2,76 €	0,12	50	40	25	26
2"	16	504 20 063 2	3,89 €	0,22	50	50	29,5	32,5
2 1/2"	16	504 20 075 2	7,70 €	0,22	30	65	30	40
3"	16	504 20 090 2	11,90 €	0,22	18	80	33	46
4"	16	504 20 110 2	18,73 €	0,22	10	100	39	52

### UH-PVC Tek Taraf İçten Dişli İnegal Te

#### UH-PVC One Side Female Threaded Reducing Tee

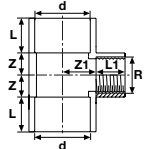

d (mm)	Rp (Inch)	Basınc PN	Kod Code	Fiyat (Adet) Price (Pcs)	Kg /Adet Kg/Pcs	Koli/Adet Box/Pcs	DN (mm)	L (mm)	L1 (mm)	Z1 (mm)	Z (mm)
50	1"	16	508 10 050032 2	2,12 €	0,14	75	40	31	21	18	26
63	1"	16	508 10 063032 2	3,38 €	0,24	40	50	38	21	18	32,5
63	1 1/2"	16	508 10 063050 2	3,30 €	0,29	30	50	38	25	26	32,5
75	2"	16	508 10 075063 2	4,65 €	0,47	35	65	44	29,5	26	40
90	2"	16	508 10 090063 2	6,53 €	0,66	25	75	51	29,5	32,5	46
90	2 1/2"	16	508 10 090075 2	7,16 €	0,68	22	75	51	30	32,5	46
110	2"	16	508 10 110063 2	9,00 €	0,77	10	100	61	29,5	40	52
110	2 1/2"	16	508 10 110075 2	9,30 €	0,95	11	100	61	30	32,5	52
110	3"	16	508 10 110090 2	9,75 €	1,00	10	100	61	33	56	52

UH-PVC Yapıştırma Mufllu İnegal Te  
UH-PVC Solvent Cement Reducing Tee

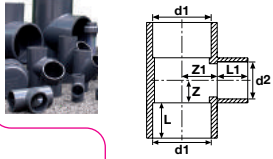

d1 (mm)	d2 (mm)	Basmaç PN	Kod Code	Fiyat (Adet) Price (Pcs)	Kg/Adet Kg/Pcs	Koli/Adet Box/Pcs	DN1 (mm)	DN2 (mm)	L (mm)	L1 (mm)	Z1 (mm)	Z (mm)	
32	20	16	508 00 032020 2	0,83 €	0,08	50	25	15	22	16	17	14	
32	25	16	508 00 032025 2	0,76 €	0,08	100	25	20	22	16	17	14	
32	50	16	508 00 032050 2	1,89 €	0,11	80	25	40	22	16	17	14	
40	20	16	508 00 040020 2	1,19 €	0,13	48	32	15	26	16	23	17	
40	25	16	508 00 040025 2	1,12 €	0,13	48	32	20	26	18,5	23	17	
40	32	16	508 00 040032 2	1,01 €	0,13	48	32	25	26	22	23	17	
50	20	16	508 00 050020 2	1,38 €	0,14	75	40	15	31	16	28	17	
50	32	16	508 00 050032 2	1,20 €	0,14	75	40	25	31	18,5	28	17	
50	40	16	508 00 050040 2	1,18 €	0,14	50	40	32	31	22	28	17	
63	25	16	508 00 063025 2	2,36 €	0,24	40	40	15	38	26	28	23	
63	32	16	508 00 063032 2	2,39 €	0,24	30	50	25	38	18,5	35	23	
63	40	16	508 00 063040 2	2,25 €	0,25	30	50	32	38	22	35	23	
63	50	16	508 00 063050 2	2,20 €	0,29	30	50	40	38	26	35	23	
<b>NEW</b>	75	32	16	508 00 075032 2	3,00 €		30	65	25	43,5	22	38,5	17
<b>NEW</b>	75	40	16	508 00 075040 2	3,00 €		30	65	32	43,5	26	38,5	23
<b>NEW</b>	75	50	16	508 00 075050 2	3,05 €		30	65	40	43,5	31	38,5	28
	75	63	16	508 00 075063 2	3,10 €	0,45	30	65	50	43,5	31	38,5	28
<b>NEW</b>	90	32	16	508 00 090032 2	4,25 €		35	80	25	51	22	46	17
<b>NEW</b>	90	40	16	508 00 090040 2	4,25 €		35	80	32	51	26	46	23
<b>NEW</b>	90	50	16	508 00 090050 2	4,30 €		35	80	40	51	31	46	28
	90	63	16	508 00 090063 2	4,35 €	0,64	35	80	50	51	38	46	35
	90	75	16	508 00 090075 2	4,50 €	0,66	25	80	65	51	38	46	35
<b>NEW</b>	110	32	16	508 00 110032 2	5,90 €		22	100	25	61	22	56	17
<b>NEW</b>	110	40	16	508 00 110040 2	5,90 €		22	100	32	61	26	56	23
<b>NEW</b>	110	50	16	508 00 110050 2	5,95 €		22	100	40	61	31	56	28
	110	63	16	508 00 110063 2	6,00 €	0,75	22	100	50	61	43,5	56	40
	110	75	16	508 00 110075 2	6,20 €	0,93	10	100	65	61	38	56	35
	110	90	16	508 00 110090 2	6,50 €	0,98	11	100	80	61	43,5	56	40
	125	63	16	508 00 125063 2	12,92 €	1,26	10	110	50	68,5	51	64	46
*	125	75	16	508 00 125075 2	12,76 €	1,71	10	110	65	68,5	38	64	35
	125	90	16	508 00 125090 2	12,12 €	1,58	8	110	80	68,5	43,5	64	40
	125	110	16	508 00 125110 2	10,75 €	1,59	8	110	100	68,5	51	64	46
*	140	63	16	508 00 140063 2	18,09 €	2,53	8	125	50	76	61	72	56
*	140	75	16	508 00 140075 2	17,97 €	2,54	6	125	65	76	38	72	35
*	140	90	16	508 00 140090 2	17,71 €	2,53	6	125	80	76	43,5	72	40
	140	110	16	508 00 140110 2	16,20 €	2,27	6	125	100	76	51	72	46
*	160	63	16	508 00 160063 2	21,89 €	2,69	5	150	50	86	61	81	56
*	160	75	16	508 00 160075 2	20,64 €	2,70	5	150	65	86	38	81	35
*	160	90	16	508 00 160090 2	20,00 €	2,69	5	150	80	86	43,5	81	40
*	160	110	16	508 00 160110 2	19,00 €	2,43	5	150	100	86	51	81	46
*	160	125	16	508 00 160125 2	21,77 €	4,15	5	150	110	86	61	81	56
*	200	75	16	508 00 200075 2	34,77 €	4,30	2	175	65	106	68,5	107	69
*	200	90	16	508 00 200090 2	34,51 €	4,29	2	175	80	106	43,5	107	40
	200	110	16	508 00 200110 2	33,00 €	4,03	2	175	100	106	51	107	46
*	200	125	16	508 00 200125 2	36,37 €	5,25	2	175	110	106	61	107	82
*	200	140	16	508 00 200140 2	34,70 €	4,96	2	175	125	106	68,5	107	82
	200	160	16	508 00 200160 2	32,50 €	4,40	2	175	150	106	76	107	82
	225	110	16	508 00 225110 2	54,60 €	4,32	2	200	100	118,5	86	120	82
*	225	125	16	508 00 225125 2	59,24 €	5,43	2	200	110	118,5	61	120	56
*	225	140	16	508 00 225140 2	57,57 €	5,14	2	200	125	118,5	68,5	120	69
	225	160	16	508 00 225160 2	55,37 €	4,58	2	200	150	118,5	76	120	72
*	225	200	10	508 00 225200 2	67,50 €	4,80	2	200	175	118,5	86	120	82
	250	110	10	508 00 250110 2	100,67 €	7,75	1	250	100	131	106	132	107
	250	140	10	508 00 250140 2	105,30 €	7,85	1	250	125	131	61	132	132
	250	160	10	508 00 250160 2	101,70 €	7,95	1	250	150	131	76	132	132
	250	200	10	508 00 250200 2	103,18 €	8,15	1	250	175	131	86	132	132
*	250	225	10	508 00 250225 2	141,95 €	10,56	1	250	200	131	106	132	132
	280	110	10	508 00 280110 5	240,00 €		1	215	100	146	118,5	146	132
*	280	140	10	508 00 280140 5	239,20 €		1	250	125	146	61	146	146
	280	160	10	508 00 280160 5	237,00 €		1	250	150	146	76	146	146
*	280	200	10	508 00 280200 5	221,50 €		1	250	175	146	86	146	146
	280	225	10	508 00 280225 5	214,00 €		1	250	200	146	106	146	146
*	280	250	10	508 00 280250 5	212,95 €		1	250	250	146	118,5	146	146

Ürün devamı yan sayfadır. ↗  
The product continuation is on the next page. ↗

### UH-PVC Yapıştırma Muflu İnegal Te

#### UH-PVC Solvent Cement Reducing Tee

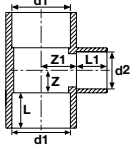

d1 (mm)	d2 (mm)	Basınç PN	Kod Code	Fiyat (Adet) Price (Pcs)	Kg/Adet Kg/Pcs	Koli/Adet Box/Pcs	DN1 (mm)	DN2 (mm)	L (mm)	L1 (mm)	Z (mm)	Z1 (mm)
315	110	10	508 00 315110 5	202,97 €	14,2	1	300	100	146	131	146	146
315	160	10	508 00 315160 2	202,97 €	13,5	1	300	150	163,5	61	168	168
315	225	10	508 00 315225 2	197,23 €	14,1	1	300	200	163,5	86	168	168
315	250	10	508 00 315250 2	275,00 €	22,3	1	300	250	163,5	118,5	168	168
*315	280	10	508 00 315280 2	255,00 €	19,9	1	300	250	163,5	131	168	168
*355	280	10	508 00 355280 5	458,00 €	33,5	1	350	250	163,5	146	168	168
*355	315	10	508 00 355315 5	423,50 €	30,1	1	350	300	183,5	146	196	152
*400	280	10	508 00 400280 5	715,05 €	46,5	1	400	250	183,5	163,5	196	175
*400	315	10	508 00 400315 5	680,55 €	43,0	1	400	300	206	146	214	152
*400	355	10	508 00 400355 5	617,05 €	36,6	1	400	350	206	163,5	214	175

\*Redüksiyon ile düşürülmüştür./Reduced with reducer.

### UH-PVC Yapıştırma Muflu 45° T

#### UH-PVC Solvent Single Branch T 45°

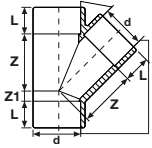

d (mm)	Basınç PN	Kod Code	Fiyat (Adet) Price (Pcs)	Kg /Adet Kg/Pcs	Koli/Adet Box/Pcs	Z (mm)	Z1 (mm)	L (mm)
*20	16	507 00 020 4	0,70 €			27	6	16
*25	16	507 00 025 4	0,75 €			33	7	18,5
*32	16	507 00 032 4	1,35 €			42	8	22
*40	16	507 00 040 4	1,75 €			51	10	26
50	16	507 00 050 4	1,80 €	0,12	80	53	12	31
63	16	507 00 063 4	2,50 €	0,23	40	79	14	38
*75	16	507 00 075 4	4,95 €		25	94	17	43,5
*90	16	507 00 090 4	7,20 €		20	122	20	51
110	16	507 00 110 4	12,00 €	1,41	15	137	24	61

\*U-PVC Borudan Konfeksiyon. / U-PVC Hand-made from pipe

### UH-PVC Yapıştırma Muflu 90° Kruva (İstavroz)

#### UH-PVC Solvent Cement 90° Cross

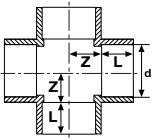

d (mm)	Basınç PN	Kod Code	Fiyat (Adet) Price (Pcs)	Kg /Adet Kg/Pcs	Koli/Adet Box/Pcs	DN	L (mm)	Z (mm)
32	16	506 00 032 2	2,50 €	0,09	110	25	22	17
40	16	506 00 040 2	2,85 €	0,14	70	32	26	21
50	16	506 00 050 2	3,30 €	0,22	35	40	31	26
63	16	506 00 063 2	5,50 €	0,37	40	50	38	32,5
75	16	506 00 075 2	6,50 €	0,55	20	65	43,5	38,5
90	16	506 00 090 2	8,20 €	0,96	12	80	51	46
110	16	506 00 110 2	16,00 €	1,62	7	100	61	56
*125	16	506 00 125 2	25,90 €	2,35	4	110	68,5	63,5
*140	16	506 00 140 5	40,50 €	2,52	4	125	76	71
160	16	506 00 160 5	52,10 €	3,95	3	150	86	81
200	16	506 00 200 5	115,00 €	5,02	1	175	106	101
*225	16	506 00 225 5	130,80 €	5,91	1	200	118,5	114
*250	16	506 00 250 5	210,20 €		1	250	131	126
*280	16	506 00 280 5	290,12 €		1	250	146	141
*315	16	506 00 315 5	350,25 €		1	300	163,5	159
*355	16	506 00 355 5	402,35 €		1	350	183,5	184
*400	16	506 00 400 5	533,40 €		1	400	206	206

\*U-PVC Borudan Konfeksiyon. / U-PVC Hand-made from pipe

**UH-PVC Yapıştırma Muflu Manşon**  
UH-PVC Double Socket

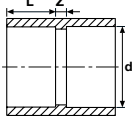

d (mm)	Basınç PN	Kod Code	Fiyat (Adet) Price (Pcs)	Kg /Adet Kg/Pcs	Koli/Adet Box/Pcs	DN	L (mm)	Z (mm)
16	16	511 00 016 2	0,27 €	1	480	12	14	3
20	16	511 00 020 2	0,17 €	0,01	480	15	16	3
25	16	511 00 025 2	0,21 €	0,02	250	20	18,5	3
32	16	511 00 032 2	0,24 €	0,01	125	25	22	3
40	16	511 00 040 2	0,38 €	0,03	100	32	26	3
50	16	511 00 050 2	0,39 €	0,06	70	40	31	3
63	16	511 00 063 2	0,61 €	0,11	135	50	38	3
75	16	511 00 075 2	1,24 €	0,17	80	65	43,5	4
90	16	511 00 090 2	1,56 €	0,30	45	80	51	5
110	16	511 00 110 2	2,64 €	0,48	28	100	61	6
125	16	511 00 125 2	3,27 €	0,7	22	110	68,5	6
140	16	511 00 140 2	3,86 €	0,9	16	125	76	8
160	16	511 00 160 2	5,78 €	1,3	12	150	86	8
200	16	511 00 200 2	13,00 €	2,15	4	175	106	8
225	16	511 00 225 2	20,85 €	3,79	2	200	118,5	10
250	10	511 00 250 4	35,60 €	4	1	250	131	12
280	10	511 00 280 5	56,36 €	7,6	1	250	146	12
315	10	511 00 315 5	69,90 €	6,98	1	300	163,5	14
355	10	511 00 355 5	103,25 €	13,9	1	350	183,5	68
400	10	511 00 400 5	119,20 €	11,6	1	400	206	73

**UH-PVC İç Dış Yapıştırma, Tek Taraf İçten Dişli Redüksiyonlu Adaptör**  
UH-PVC One Side Female Threaded Reducer Adaptor

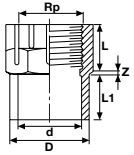

d (mm)	Rp (Inch)	Basınç PN	Kod Code	Fiyat (Adet) Price (Pcs)	Kg /Adet Kg/Pcs	Koli/Adet Box/Pcs	D (mm)	L (mm)	L1 (mm)	Z (mm)
20	1/2"	16	518 00 020 2	0,25 €	0,01	450	25	12	16	5,5
25	3/4"	16	518 00 025 2	0,28 €	0,02	240	32	16	22	1,5
32	1"	16	518 00 032 2	0,32 €	0,03	180	40	19	27	1,5
40	1 1/4"	16	518 00 040 2	0,60 €	0,06	80	50	22	27	5
50	1 1/2"	16	518 00 050 2	0,85 €	0,13	100	63	19	38	9,5
63	2"	16	518 00 063 2	1,20 €	0,17	75	75	24	39	6

**UH-PVC İç Yapıştırma, İçten Dişli Adaptör**  
UH-PVC One Side Solvent , One Side Female Threaded Adaptor

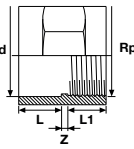

d (mm)	Rp (Inch)	Basınç PN	Kod Code	Fiyat (Adet) Price (Pcs)	Kg /Adet Kg/Pcs	Koli/Adet Box/Pcs	L (mm)	L1 (mm)	Z (mm)
75	2 1/2"	16	519 00 075 2	1,85 €	0,24	75	44	32	7
90	3"	16	519 00 090 2	2,30 €	0,31	60	52	36	9
110	4"	16	519 00 110 2	3,70 €	0,47	18	61	40	9
125	4 1/2"	16	519 00 125 5	8,80 €	0,86	22	69	44	40
140	5"	16	519 00 140 5	9,43 €	1,06	16	75	44	40
160	6"	10	519 00 160 5	14,15 €	1,56	12	86	50	50
200	7"	10	519 00 200 5	36,21 €	2,34	4	106	55	50
225	8"	10	519 00 225 5	56,46 €	3,09	2	120	60	55
250	9"	10	519 00 250 5	67,01 €	3,90	2	131	60	55

**UH-PVC Dış Yapıştırma, Çift Taraf İçten Dişli Redüksiyonlu Adaptör**  
UH-PVC Outside Part Solvent , Both Inside Part Female Threaded Reducer Adaptor

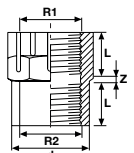

d (mm)	R1-R2 (inch)	Basınç PN	Kod Code	Fiyat (Adet) Price (Pcs)	Kg /Adet Kg/Pcs	Koli/Adet Box/Pcs	L (mm)	Z (mm)
25	1/2"	16	518 10 020 2	0,38 €	0,01	450	12	5,5
32	3/4"	16	518 10 025 2	0,42 €	0,02	240	16	1,5
40	1"	16	518 10 032 2	0,48 €	0,03	180	19	1,5
50	1 1/4"	16	518 10 040 2	0,90 €	0,06	80	22	5
63	1 1/2"	16	518 10 050 2	1,28 €	0,15	100	19	9,5
75	2"	16	518 10 063 2	1,80 €	0,15	75	24	6

### UH-PVC Çift Taraf İçten Dişli Adaptör

UH-PVC Both Side Female Adaptor

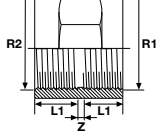

R1 (inch)	R2 (inch)	Basınç PN	Kod Code	Fiyat (Adet) Price (Pcs)	Kg /Adet Kg/Pcs	Koli/Adet Box/Pcs	L1 (mm)	Z (mm)
75	2 1/2"	16	519 10 075 2	2,78 €		75	32	7
90	3"	16	519 10 090 2	3,45 €		60	36	9
110	4"	16	519 10 110 2	5,55 €		18	40	9

### UH-PVC Dış Diş İç Diş Redüksiyonlu Adaptör

UH-PVC One Side Female Other Side Male Threaded Adaptor

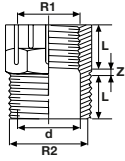

R1 Inch	R2 Inch	Basınç PN	Kod Code	Fiyat (Adet) Price (Pcs)	Kg /Adet Kg/Pcs	Koli/Adet Box/Pcs	L (mm)	Z (mm)
1 1/4"	1 1/2"	16	518 20 040 2	0,90 €	0,04	80	22	5
1 1/2"	1 1/2"	16	518 20 050 2	1,35 €	0,07	150	19	9,5
2 1/2"	2"	16	508 20 050 2	1,28 €	0,09	95	19	9,5
2"	2"	16	518 20 063 2	2,03 €	0,10	160	24	6
2"	2 1/2"	16	518 20 063 3	1,80 €	0,14	75	24	6
2 1/2"	3"	16	518 20 075 2	2,78 €		75	32	7
4"	4 1/2"	16	518 20 110 2	5,55 €		18	36	9

### UH-PVC İçten Dişli Redüksiyon

UH-PVC Female Threaded Reducing Tee

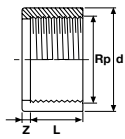

d (mm)	Rp Inch	Basınç PN	Kod Code	Fiyat (Adet) Price (Pcs)	Kg /Adet Kg/Pcs	Koli/Adet Box/Pcs	L (mm)	Z (mm)
25	1/2"	16	509 10 025020 2	0,22 €	0,004	1200	16	3
32	1/2"	16	509 10 032020 2	0,36 €	0,01	600	16	7
40	3/4"	16	509 10 040025 2	0,50 €	0,02	300	20	7
40	1"	16	509 10 040032 2	0,28 €	0,01	300	20	6
50	1"	16	509 10 050032 2	0,34 €	0,03	200	25	6
50	1 1/4"	16	509 10 050040 2	0,70 €	0,02	200	23	9
63	1"	16	509 10 063032 2	1,24 €	0,07	100	22	16
63	1 1/2"	16	509 10 063050 2	0,88 €	0,05	100	30	8
75	1 1/2"	16	509 10 075050 2	1,30 €	0,09	30	31	13
75	2"	16	509 10 075063 2	0,87 €	0,07	30	36	8
90	2"	16	509 10 090063 2	1,54 €	0,14	65	38	13
90	2 1/2"	16	509 10 090075 2	1,27 €	0,13	65	43	8
110	2"	16	509 10 110063 2	3,77 €	0,26	75	38	23
110	2 1/2"	16	509 10 110075 2	1,53 €	0,27	75	44	17
110	3"	16	509 10 110090 2	3,02 €	0,26	75	50	10

### UH-PVC Dış Y.M. İç Diş Redüksiyonlu Adaptör

UH-PVC One Side Female Threaded Reducer Adaptor

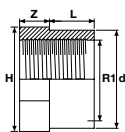

d (mm)	R1 Inch	Basınç PN	Kod Code	Fiyat (Adet) Price (Pcs)	Kg /Adet Kg/Pcs	Koli/Adet Box/Pcs	L (mm)	Z (mm)	H (mm)
32	3/4"	16	518 20 025 2	0,42 €	0,01	550	12	8	28
40	1"	16	518 20 032 2	0,48 €	0,01	250	14,4	9	35
50	1 1/4"	16	518 21 040 2	0,80 €	0,02	180	16,8	9	44
63	2"	16	518 20 063 2	2,03 €	0,06	120	21,1	12	68

**UH-PVC Yapıştırma Muflu Kör Tapa**  
UH-PVC Solvent Cement End Cap

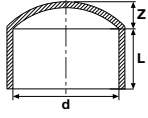

d (mm)	Basınç PN	Kod Code	Fiyat (Adet) Price (Pcs)	Kg /Adet Kg/Pcs	Koli/Adet Box/Pcs	DN	L (mm)	Z (mm)
20	16	516 00 020 2	0,18 €	0,008	700	15	16	5,5
25	16	516 00 025 2	0,22 €	0,01	600	20	18,5	7
32	16	516 00 032 2	0,28 €	0,02	350	25	22	8,5
40	16	516 00 040 2	0,33 €	0,04	250	32	26	10
50	16	516 00 050 2	0,50 €	0,05	100	40	31	12
63	16	516 00 063 2	0,60 €	0,08	100	50	38	16
75	16	516 00 075 2	1,02 €	0,17	60	65	43,5	18
90	16	516 00 090 2	1,30 €	0,34	35	80	51	20
110	16	516 00 110 2	1,90 €	0,34	25	100	61	24
125	16	516 00 125 2	3,10 €	0,46	15	110	68,5	26
140	16	516 00 140 2	3,90 €	0,82	10	125	76	30
160	16	516 00 160 2	7,10 €	1,16	8	150	86	38
200	16	516 00 200 2	11,30 €	1,46	8	175	106	44
225	16	516 00 225 2	19,00 €	2,31	6	200	118,5	50
250	10	516 00 250 2	29,00 €	2,87	2	250	131	55
280	10	516 00 280 2	41,00 €	4,81	2	250	146	60
315	10	516 00 315 2	54,00 €	5,87	1	300	163,5	64
355	10	516 00 355 4	125,80 €	9,30	1	350	183,5	67
400	10	516 00 400 4	142,35 €	16,2	1	400	206	71
*450	10	516 00 450 5	280,00 €	-	1	-	-	-
*500	10	516 00 500 5	335,00 €	-	1	-	-	-

**UH-PVC İçten Dişli Kör Tapa**  
UH-PVC Female Threaded Cap

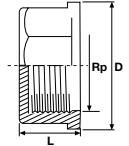
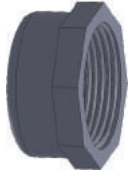

d (mm)	Rp Inch	Basınç PN	Kod Code	Fiyat (Adet) Price (Pcs)	Kg /Adet Kg/Pcs	Koli/Adet Box/Pcs	L (mm)	D (mm)
20	1/2"	16	517 00 020 2	0,39 €	0,01	700	19,5	26
25	3/4"	16	517 00 025 2	0,52 €	0,08	600	20,5	31
32	1"	16	517 00 032 2	0,65 €	0,024	250	24	39
40	1 1/4"	16	517 00 040 2	0,75 €	0,027	150	26,5	51
50	1 1/2"	16	517 00 050 2	1,10 €	0,082	90	27	56
63	2"	16	517 00 063 2	1,60 €	0,067	100	33,5	70
75	2 1/2"	16	517 00 075 2	2,75 €	0,23	60	40	88
90	3"	16	517 00 090 2	3,85 €	0,2	35	44	102
110	4"	16	517 00 110 2	4,95 €	0,29	25	50	128

**UH-PVC Dıştan Dişli Kör Tapa**  
UH-PVC Solvent Cement Threaded Plug (Metric-R)

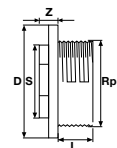

Rp Inch	Basınç PN	Kod Code	Fiyat (Adet) Price (Pcs)	Kg /Adet Kg/Pcs	Koli/Adet Box/Pcs	D (mm)	L (mm)	Z (mm)	S (mm)
2"	16	523 00 063 2	1,25 €	0,06	100	75	31	12	65
2 1/2"	16	523 00 075 2	2,45 €	0,11	60	90	34	16	94
4"	16	523 00 110 2	5,80 €	0,2	30	110	40	17	138



## UH-PVC Yapıştırma Mufllu Redüksiyon

### UH-PVC Solvent Cement Reducer

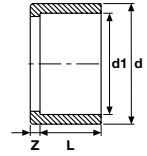
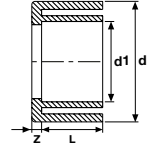

d (mm)	d1 (mm)	Basınç PN	Kod Code	Fiyat (Adet) Price (Pcs)	Kg /Adet Kg/Pcs	Koli/Adet Box/Pcs	L (mm)	Z (mm)
20	16	16	509 00 020016 2	0,18 €	0,004	1500	14	2
25	20	16	509 00 025020 2	0,11 €	0,004	1000	16	3
32	20	16	509 00 032020 2	0,18 €	0,01	500	16	7
32	25	16	509 00 032025 2	0,11 €	0,01	500	18,5	4
40	20	16	509 00 040020 2	0,36 €	0,02	300	16	10
40	25	16	509 00 040025 2	0,25 €	0,02	300	18,5	7
40	32	16	509 00 040032 2	0,14 €	0,01	300	22	4
50	32	16	509 00 050032 2	0,35 €	0,03	200	22	9
50	40	16	509 00 050040 2	0,29 €	0,02	200	26	5
63	32	16	509 00 063032 2	0,62 €	0,07	100	22	16
63	40	16	509 00 063040 2	0,74 €	0,07	100	26	11
63	50	16	509 00 063050 2	0,45 €	0,05	100	31	6,5
75	40	16	509 00 075040 2	0,95 €	0,08	60	26	17,5
75	50	16	509 00 075050 2	0,65 €	0,09	60	31	13
75	63	16	509 00 075063 2	0,44 €	0,07	60	38	6
90	32	16	509 00 090032 2	1,44 €	0,13	65	22	25
90	50	16	509 00 090050 2	1,19 €	0,14	70	31	20
90	63	16	509 00 090063 2	0,77 €	0,14	70	38	13
90	75	16	509 00 090075 2	0,64 €	0,13	70	43,5	8
110	63	16	509 00 110063 2	1,89 €	0,26	40	38	23
110	75	16	509 00 110075 2	1,77 €	0,27	40	44	17
110	90	16	509 00 110090 2	1,51 €	0,26	40	51	10
125	63	16	509 00 125063 2	3,15 €	0,40	25	38	31
125	75	16	509 00 125075 2	3,05 €	0,42	25	43,5	25
125	90	16	509 00 125090 2	2,40 €	0,38	25	51	18
125	110	16	509 00 125110 2	1,37 €	0,25	25	61	7,5
140	63	16	509 00 140063 2	5,10 €	0,525	35	38	40
140	75	16	509 00 140075 2	4,80 €	0,5	35	43,5	33
140	90	16	509 00 140090 2	3,75 €	0,49	35	51	25
140	110	16	509 00 140110 2	2,49 €	0,50	33	61	15
140	125	16	509 00 140125 2	1,67 €	0,294	25	68,5	7,5
160	90	16	509 00 160090 2	5,70 €	0,70	12	51	35
160	110	16	509 00 160110 2	4,10 €	0,76	15	61	25
160	140	16	509 00 160140 2	2,20 €	0,56	15	76	10
200	160	16	509 00 200160 2	6,25 €	1,22	12	86	20
225	200	16	509 00 225200 2	7,50 €	1,34	6	106	13
*250	200	16	509 00 250200 2	25,45 €	2,98	6	106	25,5
250	225	16	509 00 250225 2	17,95 €	1,64	6	118,5	12,5
280	250	16	509 00 280250 2	22,95 €	2,43	2	131	16
315	280	16	509 00 315280 2	34,50 €	3,54	2	146	17
*355	280	16	509 00 355 280 5	98,00 €	10,40	1	146	44
355	315	16	509 00 355315 5	63,50 €	6,41	1	163,5	27
*400	280	16	509 00 400280 5	225,05 €	18,9	1	146	67
*400	315	16	509 00 400315 5	190,55 €	14,9	1	163,5	50
400	355	16	509 00 400355 5	127,05 €	8,53	1	183,5	23

\*Redüksiyon ile düşürülmüştür./Reduced with reducer.

## UH-PVC Yapıştırma Mufllu Konik Redüksiyon

### UH-PVC Solvent Cement Conical Reducer

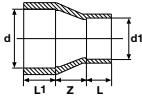

d (mm)	d1 (mm)	Basınç PN	Kod Code	Fiyat (Adet) Price (Pcs)	Kg /Adet Kg/Pcs	Koli/Adet Box/Pcs	Z (mm)	L1 (mm)	L2 (mm)	L3 (mm)
160	110	16	510 00 160110 2	11,50 €	1,27	12	126	96	86	61
225	110	16	510 00 225110 2	21,88 €	2,64	3	109	130	118,5	61
225	160	16	510 00 225160 2	22,17 €	2,66	3	109	130	118,5	86

## UH-PVC Yapıştırma Mufllu Eksantrik Redüksiyon

### UH-PVC Solvent Cement Excentric Reducer

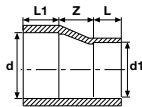

d (mm)	d1 (mm)	Basınç PN	Kod Code	Fiyat (Adet) Price (Pcs)	Kg /Adet Kg/Pcs	Koli/Adet Box/Pcs	L (mm)	L1 (mm)	Z (mm)
250	200	16	510 00 250 200 2	32,53 €	3,37	2	106,5	131	37,8
250	225	16	510 00 250 225 2	34,53 €	3,38	2	119,5	131	24,5

**UH-PVC Yapıştırma Mufllu Kole**  
UH-PVC Solvent Cement Flange Adaptor

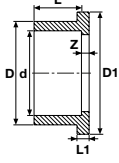

d mm	Basınç PN	Kod Code	Fiyat (Adet) Price (Pcs)	Kg /Adet Kg/Pcs	Koli/Adet Box/Pcs	DN1 (mm)	D (mm)	D1 (mm)	L (mm)	L1 (mm)	Z (mm)
16	16	512 00 016 2	0,75 €	0,012	600	12	22	34,0	14,0	7	3
20	16	512 00 020 2	0,55 €	0,009	750	15	27	34,0	16,0	7	3
25	16	512 00 025 2	0,55 €	0,01	450	20	33	41,0	19,0	7	3
32	16	512 00 032 2	0,70 €	0,02	250	25	41	50,0	22,0	7	3
40	16	512 00 040 2	0,79 €	0,04	150	32	50	61,0	26,0	8	3
50	16	512 00 050 2	0,79 €	0,06	160	40	60	73,0	31,0	8	3
63	16	512 00 063 2	0,81 €	0,09	100	50	77	91,0	38,0	9	3
75	16	512 00 075 2	1,00 €	0,16	70	65	90	106,0	43,5	10	3
90	16	512 00 090 2	1,30 €	0,23	85	80	107	125,0	51,0	11	5
110	16	512 00 110 2	2,07 €	0,41	45	100	129	150,0	61,0	12	5
125	16	512 00 125 2	2,75 €	0,60	24	110	147	170,0	69,0	13	5
140	16	512 00 140 2	3,60 €	0,78	18	125	164	188,0	76,0	14	5
160	16	512 00 160 2	5,28 €	1,10	16	150	188	213,0	86,0	16	5
200	16	512 00 200 2	7,42 €	1,45	7	175	230	255,0	106,0	18	6
225	16	512 00 225 2	8,05 €	2,06	3	200	245	274,0	120,0	24	6
250	10	512 00 250 2	33,00 €	2,75	4	250	269	303,0	131,0	20	9
280	10	512 00 280 2	34,00 €	3,05	2	250	304	329,0	146,0	20	5
315	10	512 00 315 2	49,50 €	3,95	2	300	341	346,0	164,0	20	8
355	10	512 00 355 5	135,00 €	5,7	1	350	384	430,0	184,0	28	10
400	4	512 00 400 4	170,00 €	7,05	1	400	450	482,0	206,0	25	10
450	4	512 00 450 5	325,00 €	-	1	-	-	-	-	-	-
500	4	512 00 500 5	385,00 €	-	1	-	-	-	-	-	-

**UH-PVC İçten Dişli Kole**  
UH-PVC Female Threaded Flange Adaptor

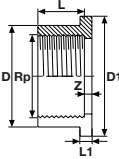

Rp Inch	Basınç PN	Kod Code	Fiyat (Adet) Price (Pcs)	Kg /Adet Kg/Pcs	Koli/Adet Box/Pcs	DN (mm)	D (mm)	D1 (mm)	L (mm)	L1 (mm)	Z (mm)
3/8"	16	512 02 016 2	1,25 €	0,01	600	12	27	34,0	14,0	7	3
1/2"	16	512 02 020 2	0,95 €	0,01	750	15	27	34,0	16,0	7	3
3/4"	16	512 02 025 2	1,15 €	0,01	450	20	33	41,0	19,0	7	3
1"	16	512 02 032 2	1,35 €	0,02	250	25	41	50,0	22,0	7	3
1 1/4"	16	512 02 040 2	1,55 €	0,03	150	32	50	61,0	26,0	8	3
1 1/2"	16	512 02 050 2	2,00 €	0,07	160	40	60	73,0	35,0	8	3
2"	16	512 02 063 2	2,25 €	0,13	100	50	77	91,0	38,0	9	3
2 1/2"	16	512 02 075 2	3,95 €	0,12	60	65	90	106,0	43,0	10	3
3"	16	512 02 090 2	4,35 €	0,27	85	80	107	125,0	51,0	11	5
4"	16	512 02 110 2	5,00 €	0,35	45	100	129	150,0	60,0	12	5

**UH-PVC Dıştan Dişli Kole**  
UH-PVC Male Threaded Flange Adaptor

NEW

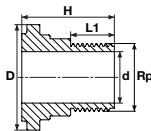
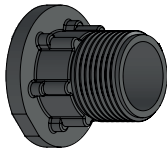

d (mm)	Rp (mm)	Basınç PN	Kod Code	Fiyat (Adet) Price (Pcs)	Kg /Adet Kg/Pcs	Koli/Adet Box/Pcs	L1 (mm)	D (mm)	H (mm)
50	1 1/2"	16	229 06 050 2	0,99 €	0,09	50	25	62,5	52
63	2"	16	229 06 063 2	1,16 €	0,14	25	27	78	57,5
63	1 1/2"	16	229 07 063 2	1,11 €	0,12	25	32	106	68

**UH-PVC Yapıştırma Flanşlı Manşon**  
UH-PVC Solvent Cement Flange Socket

NEW

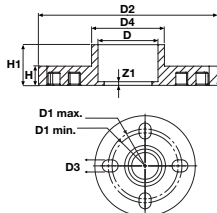

d (mm)	Basınç PN	Kod Code	Fiyat (Adet) Price (Pcs)	Koli/Adet Box/Pcs	D1 Min. (mm)	D1 Max. (mm)	D2 (mm)	D3 (mm)	D4 (mm)	N (Adet)	H (mm)	H1 (mm)	Z1 (mm)
*20	16	512 50 020 2	1,62 €		60,5	65	95	15,75	27	4	12	21,5	3
25	16	512 50 025 2	1,62 €		70	75	105	15,75	33	4	12	21,5	3
*32	16	512 50 032 2	1,90 €		79,2	85	115	15,75	41	4	14	25	3
*40	16	512 50 040 2	2,18 €		88,9	100	140	18	50	4	15	29	3
*50	16	512 50 050 2	2,18 €		98,6	110	150	18	61	4	16	34	3
63	16	512 50 063 2	2,34 €		120,6	124	165	19	76	4	18	40,5	3
75	16	512 50 075 2	3,00 €		139,7	145	185	19	90	4	19	46,5	3
90	16	512 50 090 2	3,52 €		152,4	160	200	19	108	8	20	56	5
110	16	512 50 110 2	4,39 €	10	180	190,5	220	19	131	8	22	66	5
*125	16	512 50 125 2	5,84 €	8	210	-	250	19	148	8	26	73,5	5
*140	16	512 50 140 2	6,61 €	8	210	-	250	19	165	8	26	81	5
160	16	512 50 160 2	9,30 €	12	240	-	285	22	188	8	28	91	5
200	16	512 50 200 2			295	-	340	22	224	8	36	111	5

\*U-PVC Borudan Konfeksiyon. / U-PVC Hand-made from pipe

## UH-PVC Yapıştırma Muflu Serbest Flanş

### UH-PVC Solvent Cement Flange

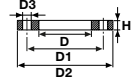
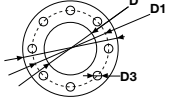

d (mm)	Basınç PN	Kod Code	Fiyat (Adet) Price (Pcs)	Kg /Adet Kg/Pcs	Koli/Adet Box/Pcs	Inch	DN (mm)	D (mm)	D1 (mm)	D2 (mm)	D3 (mm)	H (mm)	N (Adet)
20	16	513 00 020 2	1,15 €	0,10	150	1/2"	15	28	65	96	14	11	4
25	16	513 00 025 2	1,15 €	0,12	100	3/4"	20	34	75	105	14	12	4
32	16	513 00 032 2	1,30 €	0,18	80	1"	25	42	85	115	14	14	4
40	16	513 00 040 2	1,50 €	0,29	50	1 1/4"	32	51	100	140	14	15	4
50	16	513 00 050 2	1,50 €	0,23	48	1 1/2"	40	62	110	150	18	16	4
63	16	513 00 063 2	1,65 €	0,30	25	2"	50	78	125	165	18	18	4
75	16	513 00 075 2	2,15 €	0,40	40	2 1/2"	65	92	145	185	18	20	4
90	16	513 00 090 2	2,40 €	0,46	35	3"	80	111	160	200	18	22	8
110	16	513 00 110 2	2,55 €	0,53	22	4"	100	133	180	220	18	24	8
125	16	513 00 125 2	3,39 €	0,78	18	4 1/2"	110	150	210	250	18	26	8
140	16	513 00 140 2	3,35 €	0,74	18	5"	125	167	210	250	18	26	8
160	16	513 00 160 2	4,50 €	0,81	14	6"	150	193	250	285	22	28	8
200	16	513 00 200 2	8,68 €	1,67	8	7"	175	234	295	340	22	32	8
225	16	513 00 225 2	8,68 €	1,23	8	8"	200	257	295	340	22	32	8
250	16	513 00 250 2	42,00 €	2,19	7	9"	250	278	325	370	22	36	8
280	10	513 00 280 2	33,60 €	1,58	7	10"	250	310	350	395	22	36	12
315	10	513 00 315 2	42,63 €	2,96	7	12"	300	348	400	445	22	36	12
355	10	513 00 355 4	130,00 €		1	14"	350	388	460	505	22	38	16
400	10	513 00 400 4	175,00 €		1	16"	400	442	515	565	26	42	16
450	10	513 00 450 5	325,00 €		1								
500	10	513 00 500 5	390,00 €		1								

## UH-PVC Tamir Flanş

### UH-PVC Repair Flange

NEW

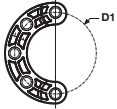
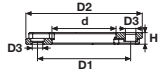

d (mm)	Basınç PN	Kod Code	Fiyat (€/Adet) Price (€/Pcs)	Kg /Adet Kg/Pcs	Koli/Adet Box/Pcs	D1 (mm)	D2 (mm)	D3 (mm)	H (mm)
90	10	513 16 090 2	4,56 €	0,430	35	160	200	18	20
110	10	513 16 110 2	4,85 €	0,535	22	180	220	18	22
125	10	513 16 125 2	6,44 €	0,820	18	210	250	18,5	25
140	10	513 16 140 2	6,36 €	0,725	18	210	250	18	25,5
160	10	513 16 160 2	8,55 €	0,950	14	240	285	22	28
200	10	513 16 200 2	16,49 €	1,450	11	295	340	22	30

## UH-PVC Yapıştırma Muflu Kör Flanş

### UH-PVC Solvent Cement Blind Flange

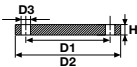
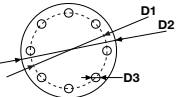

d mm	Basınç PN	Kod Code	Fiyat (Adet) Price (Pcs)	Kg /Adet Kg/Pcs	Koli/Adet Box/Pcs	Inch	DN (mm)	D1 (mm)	D2 (mm)	D3 (mm)	H (mm)	N (Adet)
20	16	514 00 020 2	2,99 €	0,09	149	1/2"	15	65	96	14	12	4
25	16	514 00 025 2	3,59 €	0,14	110	3/4"	20	75	105	14	13	4
32	16	514 00 032 2	4,19 €	0,17	80	1"	25	85	115	14	15	4
40	16	514 00 040 2	4,79 €	0,28	50	1 1/4"	32	100	140	14	16	4
50	16	514 00 050 2	5,79 €	0,37	48	1 1/2"	40	110	150	18	17	4
63	16	514 00 063 2	6,39 €	0,57	25	2"	50	125	165	18	20	4
75	16	514 00 075 2	7,19 €	0,74	16	2 1/2"	65	145	185	18	21	4
90	16	514 00 090 2	7,79 €	0,85	14	3"	80	160	200	18	22	8
110	16	514 00 110 2	7,50 €	1,56	11	4"	100	180	220	18	24	8
125	16	514 00 125 2	9,65 €	1,62	18	4 1/2"	125	210	250	18	28	8
140	16	514 00 140 2	9,65 €	1,62	18	5"	125	210	250	18	28	8
160	16	514 00 160 2	13,50 €	2,58	18	6"	150	250	285	22	28	8
200	16	514 00 200 2	36,00 €	3,82	14	7"	200	295	340	22	32	8
225	16	514 00 225 2	36,00 €	3,82	8	7"	200	295	340	22	32	8
250	16	514 00 250 4	117,00 €		8	8"	250	350	395	22	36	8
280	10	514 00 280 4	117,00 €		8	9"	250	350	395	22	36	12
315	10	514 00 315 4	152,00 €		7	10"	300	400	445	22	36	12
355	10	514 00 355 4	272,00 €		7	12"	350	460	505	22	38	16
400	10	514 00 400 4	290,00 €		7	14"	400	515	565	26	40	16
450	10	514 00 450 5	560,00 €		7	16"						
500	10	514 00 500 5	675,00 €		7							

**UH-PVC Yapıştırma Mufllu Flanş Takım**  
UH-PVC Solvent Cement Flange Set

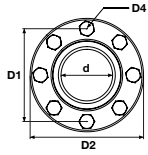
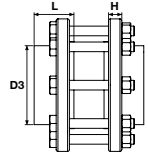

d (mm)	Inch	Basınç PN	Kod Code	Fiyat (Adet) Price (Pcs)	Kg /Adet Kg/Pcs	Koli/Adet Box/Pcs	DN (mm)	D1 (mm)	D2 (mm)	D3 (mm)	D4 (mm)	L (Adet) (mm)	H (mm)	N (Adet)
20	1/2"	16	513 07 020 2	11,62 €		16	15	65	96	27	14	17	11	4
25	3/4"	16	513 07 025 2	11,62 €		16	20	75	105	33	14	22	12	4
32	1"	16	513 07 032 2	12,22 €		16	25	85	115	41	14	25	14	4
40	1 1/4"	16	513 07 040 2	12,80 €		16	32	100	140	50	14	29	15	4
50	1 1/2"	16	513 07 050 2	12,80 €		16	40	110	150	60	18	34	16	4
63	2"	16	513 07 063 2	13,14 €	1,64	8	50	125	165	77	18	41	18	4
75	2 1/2"	16	513 07 075 2	14,82 €	2,06	4	65	145	185	90	18	46,5	20	4
90	3"	16	513 07 090 2	18,14 €	3,43	4	80	160	200	107	18	56	22	8
110	4"	16	513 07 110 2	21,18 €	3,90	4	100	180	220	129	18	66	24	8
125	4 1/2"	16	513 07 125 2	24,22 €	4,80	2	110	210	250	147	18	74	26	8
140	5"	16	513 07 140 2	26,22 €	5,30	2	125	210	250	164	18	81	26	8
160	6"	16	513 07 160 2	32,55 €	6,00	2	150	250	285	188	22	91	28	8
200	7"	16	513 07 200 2	50,38 €	8,60	1	175	295	340	230	22	112	32	8
225	8"	10	513 07 225 2	52,62 €	8,80	1	200	295	340	245	22	126	32	8
250	9"	10	513 07 250 2	172,46 €	13,50	1	250	325	370	269	22	140	36	8
280	10"	10	513 07 280 2	159,31 €	12,85	1	250	350	395	304	22	151	36	12
315	12"	10	513 07 315 2	215,04 €	15,80	1	300	400	445	341	22	172	36	12
355	14"	10	513 07 355 2	567,23 €		1	350	460	505	384	22	194	38	16
400	16"	10	513 07 400 2	736,98 €		1	400	515	565	450	26	216	42	16
*450	-	10	513 07 450 2	1,357,68 €		1	-	-	-	-	-	-	-	-
*500	-	10	513 07 500 2	1,627,68 €		1	-	-	-	-	-	-	-	-

\*Konfeksiyon. / Hand-made

**UH-PVC Yapıştırma Mufllu Beton Geçiş Flanşı**  
UH-PVC Solvent Cement Wall Cross Flange

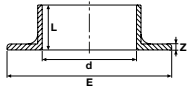

d mm	Inch	Basınç PN	Kod Code	Fiyat (Adet) Price (Pcs)	Kg /Adet Kg/Pcs	Koli/Adet Box/Pcs	DN (mm)	E (mm)	L (mm)	Z (mm)
50	1 1/2"	16	515 00 050 2	0,25 €	0,03	200	40	80	26	4
63	2"	16	515 00 063 2	0,30 €	0,04	125	50	96	30	4
75	2 1/2"	16	515 00 075 2	0,45 €	0,06	90	65	111	30	4
90	3"	16	515 00 090 2	0,60 €	0,07	100	80	129	30	5
110	4"	16	515 00 110 2	0,68 €	0,08	80	100	149	30	5
125	4 1/2"	16	515 00 125 2	0,98 €	0,11	35	110	164	31	5
140	5"	16	515 00 140 2	1,00 €	0,12	33	125	180	31	5
160	6"	16	515 00 160 2	1,15 €	0,13	50	150	199	31	5
200	7"	16	515 00 200 2	1,50 €	0,13	25	175	245	20	6
*225	7"	10	515 00 225 2	8,00 €	0,16	10	200	308	41	6
*250	8"	10	515 00 250 5	11,00 €		7	250	272	57	8
*280	9"	10	515 00 280 5	17,80 €		6	250	329	70	8
*315	10"	10	515 00 315 5	21,00 €		5	300	346	80	9
*355	12"	10	515 00 355 5	33,00 €		5	350	430	92	9
*400	14"	10	515 00 400 5	44,00 €		5	400	482	103	9

\*U-PVC Borudan Konfeksiyon. / U-PVC Hand-made from pipe

**EPDM Yaprak Conta**  
EPDM Rubber Flat Gasket

NEW



Çap Dia	Kod Code	Fiyat (Adet) Price (Pcs)	Kg /Adet Kg/Pcs	Poşet/Adet Bag/Pcs
63	221 05 063 9	6,30 €	10,50	50
75	221 05 075 9	6,60 €	15,00	50
90	221 05 090 9	6,90 €	21,50	50
110	221 05 110 9	8,10 €	22,50	50
125	221 05 125 9	8,10 €	52,50	50
140	221 05 140 9	8,48 €	60,50	50
160	221 05 160 9	9,15 €		50
200	221 05 200 9	10,50 €		20
225	221 05 225 9	11,48 €		20
250	221 05 250 9	14,78 €		20
280	221 05 280 9	16,43 €		20
315	221 05 315 9	23,10 €		20
355	221 05 355 9	29,55 €		20
400	221 05 400 9	39,30 €		20

## UH-PVC Yapıştırma Mufllu TYP-B Dıştan Dişli Depo Bağlantı Adaptörü (Uzun Tip)

### UH-PVC Solvent Cement TYP-B Male Threaded Tank Adaptor (Long Type)

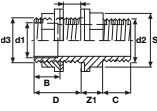

d1 (mm)	Basınç PN	Kod Code	Fiyat (Adet) Price (Pcs)	Kg /Adet Kg/Pcs	Koli/Adet Box/Pcs	d2 (mm)	d3 (mm)	Z1 (mm)	Z2 (mm)	B (mm)	C (mm)	D (mm)	S (mm)
20	10	528 00 020 5	4,52 €	0,03	20	3/4"	3/4"	13	0-23	16	17	42	32
25	10	528 00 025 5	4,52 €	0,05	10	1"	1"	15	0-23	19	21	45	40
32	10	528 00 032 5	4,52 €	0,10	40	1 1/4"	1 1/4"	17	0-26	22	23	49	50
40	10	528 00 040 5	4,52 €	0,22	50	1 1/2"	1 3/4"	19	0-21	26	23	48	60
50	10	528 00 050 5	13,16 €	0,25	50	2"	2"	21	0-21	31	27	52	69
50	10	528 01 050 5		0,38	50	2"	2 1/4"	21	0-21	31	27	52	76
63	10	528 00 063 5	18,06 €	0,37	20	2 1/2"	2 1/2"	23	0-23	38	31	53	85
75	10	528 00 075 5	30,00 €	0,59	5	3"	3"	26	0-20	44	34	56	100
90	10	528 00 090 5	40,00 €	0,69	10	4"	113"	32	0-20	51	40	62	125
*110	10	528 00 110 5	50,00 €	1,58	12								
*125	10	528 00125 5	85,00 €	0,30	1								
*140	10	528 00 140 5	95,00 €	1,97	4								
*160	10	528 00 160 5	125,00 €		2								
*200	10	528 00 200 5	205,00 €		1								

\*U-PVC Borudan Konfeksiyon. / U-PVC Hand-made from pipe

## UH-PVC Dış Dişli Parça

### UH-PVC Male Threaded Piece

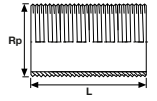

Rp Inch	Basınç PN	Kod Code	Fiyat (Adet) Price (Pcs)	Kg /Adet Kg/Pcs	Koli/Adet Box/Pcs	L (mm)
1/2"	16	526 00 020 5	2,95 €	0,01	400	60
3/4"	16	526 00 025 5	2,95 €	0,01	225	60
1"	16	526 00 032 5	2,95 €	0,02	140	80
1 1/4"	16	526 00 040 5	3,02 €	0,04	150	80
1 1/5"	16	526 00 050 5	9,90 €	0,06	125	80
2"	16	526 00 063 5	12,70 €	0,12	70	100
2 1/2"	16	526 00 075 5	19,90 €	0,21	80	120
3"	16	526 00 090 5	27,50 €	0,38	40	150
4"	10	526 00 110 5	34,50 €	0,50	30	150

## UH-PVC Somun

### UH-PVC Male Threaded Piece

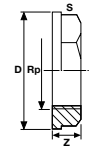

Rp Inch	Basınç PN	Kod Code	Fiyat (Adet) Price (Pcs)	Kg /Adet Kg/Pcs	Koli/Adet Box/Pcs	L (mm)	Z (mm)	s (mm)
1/2"	16	527 00 020 4	0,80 €	0,01	400	35	13	32
3/4"	16	527 00 025 4	0,80 €	0,01	400	39	13	32
1"	16	527 00 032 4	1,10 €	0,02	240	48	15	40
1 1/4"	16	527 00 040 4	1,60 €	0,02	300	58	17	50
1 1/5"	16	527 00 050 4	1,80 €	0,04	150	65	18	56
2"	16	527 00 063 4	2,70 €	0,04	140	79	21	69
2 1/2"	16	527 00 075 4	5,10 €	0,06	25	94	23	85
3"	16	527 00 090 4	6,40 €	0,10	20	112	26	100
4"	16	527 00 110 4	7,80 €	0,16	2	160	36	147

## U-PVC Depo Bağlantı Adaptör Yaprak Contası EPDM

### U-PVC Tank Adaptor EPDM Rubber Flat Gasket



Çap Dia	Kod Code	Fiyat (Adet) Price (Pcs)	Kg /Adet Kg/Pcs	Poşet/Adet Bag/Pcs
20	221 05 020 1	6,30 €	1,50	100
25	221 05 025 1	6,60 €	2,50	100
32	221 05 032 1	6,90 €	5,00	100
40	221 05 040 1	8,10 €	6,00	100
50	221 05 050 1	8,10 €	7,00	100
63	221 05 063 1	8,48 €	10,50	100
75	221 05 075 1	9,15 €	15,00	100
90	221 05 090 1	10,50 €	21,50	100
110	221 05 110 1	11,48 €	23,50	100

### UH-PVC Dıştan Dişli Redüksiyonlu Adaptör UH-PVC Male Threaded Reducer Adaptor

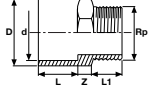

d (mm)	Rp Inch	Basınç PN	Kod Code	Fiyat (Adet) Price (Pcs)	Kg /Adet Kg/Pcs	Koli/Adet Box/Pcs	D (mm)	L (mm)	L1 (mm)	Z (mm)
20	1/2"	16	522 00 020 2	0,24 €	0,01	400	25	19	15	10
25	3/4"	16	522 00 025 0	0,30 €	0,02	250	32	22	16	11
32	1"	16	522 00 032 2	0,35 €	0,03	160	40	26	19	11
40	1 1/4"	16	522 00 040 2	0,70 €	0,06	100	50	31	21	14
50	1 1/2"	16	522 00 050 2	0,90 €	0,10	150	63	38	22	8
63	2"	16	522 00 063 2	1,35 €	0,16	100	75	44	27	9
75	2 1/2"	16	522 00 075 2	1,85 €	0,24	48	90	51	30	16
90	3"	16	522 00 090 2	3,15 €	0,44	27	110	61	33	20
110	4"	16	522 00 110 2	4,05 €	0,47	26	125	68	39	19

### UH-PVC Dış Dişli Dıştan Yapıştırırmalı Adaptör (Uzun Tip) UH-PVC Male Threaded Adaptor (Long Type)

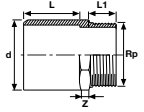

d (mm)	Rp Inch	Basınç PN	Kod Code	Fiyat (Adet) Price (Pcs)	Kg /Adet Kg/Pcs	Koli/Adet Box/Pcs	L (mm)	L1 (mm)	Z (mm)
50	1/2"	16	524 00 050 2	0,91 €	0,09	125	60,0	22,0	14
63	2"	16	524 00 063 2	1,25 €	0,14	70	70,0	30,0	15
75	2 1/2"	16	524 00 075 2	2,15 €	0,22	80	87,0	30,0	15
90	3"	16	524 00 090 2	3,15 €	0,37	40	108,0	35,0	15
110	4"	16	524 00 110 2	3,60 €	0,45	30	94,0	40,0	30
* 125	4 1/2"	16	524 00 125 2	9,22 €	1,02	14	126,0	44,0	40
* 140	5"	16	524 00 140 2	10,76 €	0,95	12	126,0	44,0	40
* 160	6"	16	524 00 160 2	14,77 €	1,14	8	111,0	50,0	50
* 200	7"	10	524 00 200 2	36,25 €	1,65	6	172,0	80,0	50

\*Konfeksiyon. / Hand-made

### UH-PVC Yapıştırma Muflu Dış Dişli Adaptör UH-PVC Solvent Cement Male Threaded Adaptor

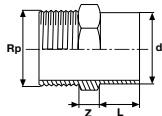

d (mm)	Rp Inch	Basınç PN	Kod Code	Fiyat (Adet) Price (Pcs)	Kg /Adet Kg/Pcs	Koli/Adet Box/Pcs	L (mm)	Z (mm)
50	1 1/2"	16	521 00 050 2	0,88 €	0,11	150	22	14
63	2"	16	521 00 063 2	1,10 €	0,12	140	27	15

### UH-PVC Tek Taraf Dış Diş Tek Taraf İç Diş Redüksiyonlu Adaptör UH-PVC One Side Female Other Side Male Threaded Reducer Adaptor

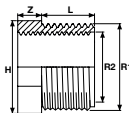

R1 Inch	R2 Inch	Basınç PN	Kod Code	Fiyat (Adet) Price (Pcs)	Kg /Adet Kg/Pcs	Koli/Adet Box/Pcs	L (mm)	Z (mm)	H (mm)
25	1/2"	16	518 20 040 3	0,42 €	0,01	550	12	8	28
32	3/4"	16	518 20 050 3	0,48 €	0,01	250	14,4	9	35
40	1"	16	518 21 050 3	0,80 €	0,02	180	16,8	9	44
63	3 1/2"	16	518 20 063 3	1,60 €	0,06	120	21,1	12	64

### UH-PVC Çift Tarafı Diş Diş Redüksiyonlu Adaptör

UH-PVC Both Sides Male Threaded Reducer Adaptor

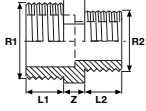

R1 Inch	R2 Inch	Basınç PN	Kod Code	Fiyat (Adet) Price (Pcs)	Kg /Adet Kg/Pcs	Koli/Adet Box/Pcs	L1 (mm)	L2 (mm)	Z (mm)
3/4"	1/2"	16	522 10 020 2	0,45 €	0,01	500	13	12	8
1"	3/4"	16	522 10 025 2	0,53 €	0,01	300	14	13	8
1 1/4"	1"	16	522 10 032 2	1,05 €	0,02	179	16	14	9
1 1/2"	1"	16	522 12 032 2	1,35 €	0,03	150	17	14	9
1 1/2"	1 1/4"	16	522 10 040 2	1,35 €	0,08	149	17	16	9
2"	1"	16	522 11 032 2	2,03 €	0,12	70	23	21	12
2"	1 1/4"	16	522 11 040 2	2,03 €	0,16	105	23	16	12
2"	1 1/2"	16	522 10 050 2	2,03 €	0,27	70	23	17	12
2 1/2"	1 1/4"	16	522 11 050 2	2,78 €	0,08	75	24	17	12
2 1/2"	2"	16	522 10 063 2	2,78 €	0,08	105	24	21	12
3"	2"	16	522 11 063 2	4,73 €	0,12	35	26	21	14
3"	2 1/2"	16	522 10 075 2	4,73 €	0,27	48	26	24	14
4"	2 1/2"	16	522 12 075 2	6,08 €	0,16	35	32	24	16
4"	2"	16	522 12 063 2	6,08 €	0,27	35	32	21	16
4"	3"	16	522 10 090 2	6,08 €	0,03	45	32	26	16

### UH-PVC Nipel

UH-PVC Barrel Nipel

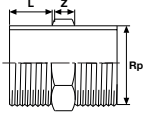

Rp Inch	Basınç PN	Kod Code	Fiyat (Adet) Price (Pcs)	Kg /Adet Kg/Pcs	Koli/Adet Box/Pcs	L (mm)	Z (mm)
1/2"	16	520 00 020 2	0,33 €	0,08	800	16,0	8,0
3/4"	16	520 00 025 2	0,37 €	0,11	500	18,0	10,0
1"	16	520 00 032 2	0,44 €	0,18	250	22,0	12,0
1 1/4"	16	520 00 040 2	0,66 €	0,32	180	23	14
1 1/2"	16	520 00 050 2	0,77 €	0,43	150	26	14
2"	16	520 00 063 2	1,01 €	0,083	120	21	12
2 1/2"	16	520 00 075 2	1,67 €	0,124	75	24	12
3"	16	520 00 090 2	2,33 €	0,171	70	26	14
4"	16	520 00 110 2	2,60 €	0,278	45	32	16
4 1/2"	16	520 00 125 5	9,60 €	0,626	20	44,0	40,0
5"	16	520 00 140 5	10,77 €	0,752	10	44,0	50,0
6"	16	520 00 160 5	15,89 €	1,6	10	50,0	50,0
7"	10	520 00 200 5	22,49 €	1,955	4	55,0	50,0

### UH-PVC Diş Dişli Hortum Adaptörü

UH-PVC One Side Male Threaded Hose Adaptor

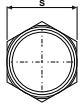
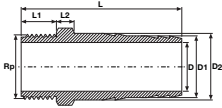

d (mm)	Basınç PN	Kod Code	Fiyat (Adet) Price (Pcs)	Kg /Adet Kg/Pcs	Koli/Adet Box/Pcs	Rp (mm)	D (mm)	D1 (mm)	D2 (mm)	L (mm)	L1 (mm)	L2 (mm)	S (mm)
20	16	525 00 020 2	0,33 €	0,01	400	1/2"	15	20,4	22	62	15	8	22
25	16	525 00 025 2	0,55 €	0,03	225	3/4"	20	25,4	28	72	16	8	28
32	16	525 00 032 2	0,66 €	0,04	140	1"	25	31,4	34	82	18	9	34
40	16	525 00 040 2	1,87 €	0,05	150	1 1/4"	32	40,4	43	95	21	13	43
50	16	525 00 050 2	2,16 €	0,08	125	1 1/2"	40	50	53	104	21	14	53
63	16	525 00 063 2	2,42 €	0,14	70	2"	50	60	66	123	26	16	66
75	16	525 00 075 2	3,50 €	0,21	80	2 1/2"				132	30		
90	16	525 00 090 2	4,95 €	0,35	40	3"				158	35		
*110	16	525 00 110 2	5,90 €	0,40	30	4"				164	40		
*125	16	525 00 125 5	14,53 €		20	4 1/2"				210	43		
*140	16	525 00 140 5	15,73 €		12	5"				210	43		
*160	16	525 00 160 5	23,03 €	1,22	8	6"				211	45		

### UH-PVC Dıştan Yapıştırımlı Hortum Adaptörü

UH-PVC Outside Part Solvent Hose Adaptor

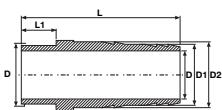

d (mm)	Basınç PN	Kod Code	Fiyat (Adet) Price (Pcs)	Kg /Adet Kg/Pcs	Koli/Adet Box/Pcs	Rp (mm)	D (mm)	D1 (mm)	D2 (mm)	L (mm)	L1 (mm)
20	16	528 80 020 2	0,33 €	0,01	400	1/2"	20	20	22	55	16
25	16	528 80 025 2	0,55 €	0,03	225	3/4"	25	25	28	67	19
32	16	528 80 032 2	0,66 €	0,04	140	1"	32	31	34	77	22
40	16	528 80 040 2	1,87 €	0,05	150	1 1/4"	40	40	43	87	26
50	16	528 80 050 2	2,16 €	0,08	125	1 1/2"	50	50	53	100	31
63	16	528 80 063 2	2,42 €	0,14	70	2"	63	60	66	119	38

**U-PVC Flanşlı Ön Filtre (Pislik Tutucu)**  
U-PVC Prefilters With Flange

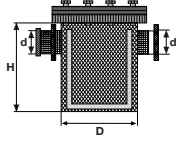

d (mm)	Kod Code	Fiyat (Adet) Price (Pcs)	Koli/kg Box/kg	Koli /Adet Kg/Pcs	D (mm)	H (mm)
63	729 00 063 5	253,00 €	15,25	1	280	37
75	729 00 075 5	264,00 €	15,25	1	280	37
90	729 00 090 5	275,00 €	15,30	1	280	37
110	729 00 110 5	286,00 €	15,35	1	315	37
125	729 00 125 5	297,00 €	19,20	1	315	37
140	729 00 140 5	308,00 €	19,25	1	315	48
160	729 00 160 5	330,00 €	21,20	1	315	48

**304 Paslanmaz Çelik Ön Filtre**  
304 Stainless Steel Prefilter



d (mm)	Kod Code	Fiyat (Adet) Price (Pcs)	Koli /Adet Kg/Pcs
75	729 01 075 5	550,00 €	1
90	729 01 090 5	615,00 €	1
110	729 01 110 5	675,00 €	1
140	729 01 140 5	920,00 €	1
160	729 01 160 5	1,072,00 €	1
225	729 01 225 5	1,515,00 €	1

**Flanşlı Ön Filtre**  
PP Prefilters With Flange



d (mm)	Kod Code	Fiyat (€/Adet) Price (€/Pcs)	Koli /Adet Kg/Pcs
90-110	729 90 110 5	300,00 €	1

**Hava Emiş Vanası (Vakum)**  
Air Suction Valve (Vacuum)



d (mm)	Kod Code	Fiyat (Adet) Price (Pcs)	Kg /Adet Kg/Pcs	Koli/Adet Box/Pcs
1" Tek Hareket (Step)	729 02 032 2	41,07 €		30
2" Tek Hareket (Step)	729 02 063 2	74,80 €		14
1" Çift Hareketli (Double Steps)	729 12 032 2	41,07 €		30
2" Çift Hareketli (Double Steps)	729 12 063 2	74,80 €		14

**Hava Purjörü**  
Air Reliff Cock



Kod Code	Fiyat (Adet) Price (Pcs)	Kg /Adet Kg/Pcs	Koli/Adet Box/Pcs
729 02 000 0	4,00 €		1

**Manometre**  
Manometer



d (mm)	Kod Code	Fiyat (Adet) Price (Pcs)	Kg /Adet Kg/Pcs	Koli/Adet Box/Pcs
3 bar	729 02 000 3	18,67 €		1
10 bar	729 02 001 0	24,00 €		1





**U-PVC**  
**PRİZ KOLYE**  
CLAMP SADDLE

**ÜRETİM STANDARDI / PRODUCTION STANDARD**

**EN 14236**  
**ÇAP / SIZE Ø25 - Ø110**

**UH-PVC Priz Kolye**  
UH-PVC Clamp Saddle (4 Bolts)

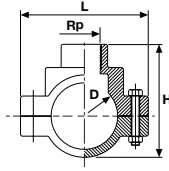

D (mm)	Rp Inch	Basınç PN	Kod Code	Fiyat (Adet) Price (Pcs)	Kg /Adet Kg/Pcs	Koli/Adet Box/Pcs	L (mm)	H (mm)
25	1/2"	16	529 00 25020 4	0,86 €	0,17	50	54	77
32	1/2"	16	529 00 32020 4	0,92 €	0,21	50	65	82
32	3/4"	16	529 00 32025 4	0,93 €	0,21	50	65	82
40	1/2"	16	529 00 40020 4	0,97 €	0,25	50	74	82
40	3/4"	16	529 00 40025 4	0,99 €	0,25	50	74	82
40	1"	16	529 00 40032 4	1,03 €	0,25	50	74	82
50	1/2"	16	529 00 50020 4	1,13 €	0,27	40	84	85
50	3/4"	16	529 00 50025 4	1,15 €	0,27	40	84	85
50	1"	16	529 00 50032 4	1,16 €	0,27	40	84	85
63	1/2"	16	529 00 63020 2	3,50 €	0,56	30	120	106
63	3/4"	16	529 00 63025 2	3,60 €	0,55	30	120	106
63	1"	16	529 00 63032 2	3,70 €	0,55	30	120	106
75	1/2"	16	529 00 75020 2	4,60 €	0,64	30	133	118
75	3/4"	16	529 00 75025 2	4,75 €	0,63	30	133	118
75	1"	16	529 00 75032 2	4,95 €	0,63	30	133	118
90	1/2"	16	529 00 90020 2	6,33 €	0,76	25	148	140
90	3/4"	16	529 00 90025 2	6,44 €	0,75	24	148	140
90	1"	16	529 00 90032 2	6,62 €	0,75	24	148	140
110	1/2"	16	529 00 11020 4	8,03 €	0,96	15	170	160
110	3/4"	16	513 00 11025 4	8,14 €	0,96	15	170	160
110	1"	16	513 00 11032 5	8,30 €	0,95	15	170	160

**UH-PVC Biberon Kolye**  
UH-PVC Clamp Saddle With Hose Adaptor

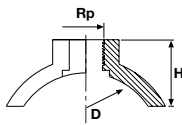

D (mm)	R Inch	Basınç PN	Kod Code	Fiyat (Adet) Price (Pcs)	Kg /Adet Kg/Pcs	Koli/Adet Box/Pcs	H (mm)
63	1/2"	16	530 00 63020 2	1,85 €	0,04	100	39
63	3/4"	16	530 00 63025 2	1,90 €	0,04	100	39
63	1"	16	530 00 63032 2	1,95 €	0,17	100	39
90	1/2"	16	530 00 90020 2	2,20 €	0,07	100	41
90	3/4"	16	530 00 90025 2	2,25 €	0,14	100	41
90	1"	16	530 00 90032 2	2,35 €	0,07	100	41

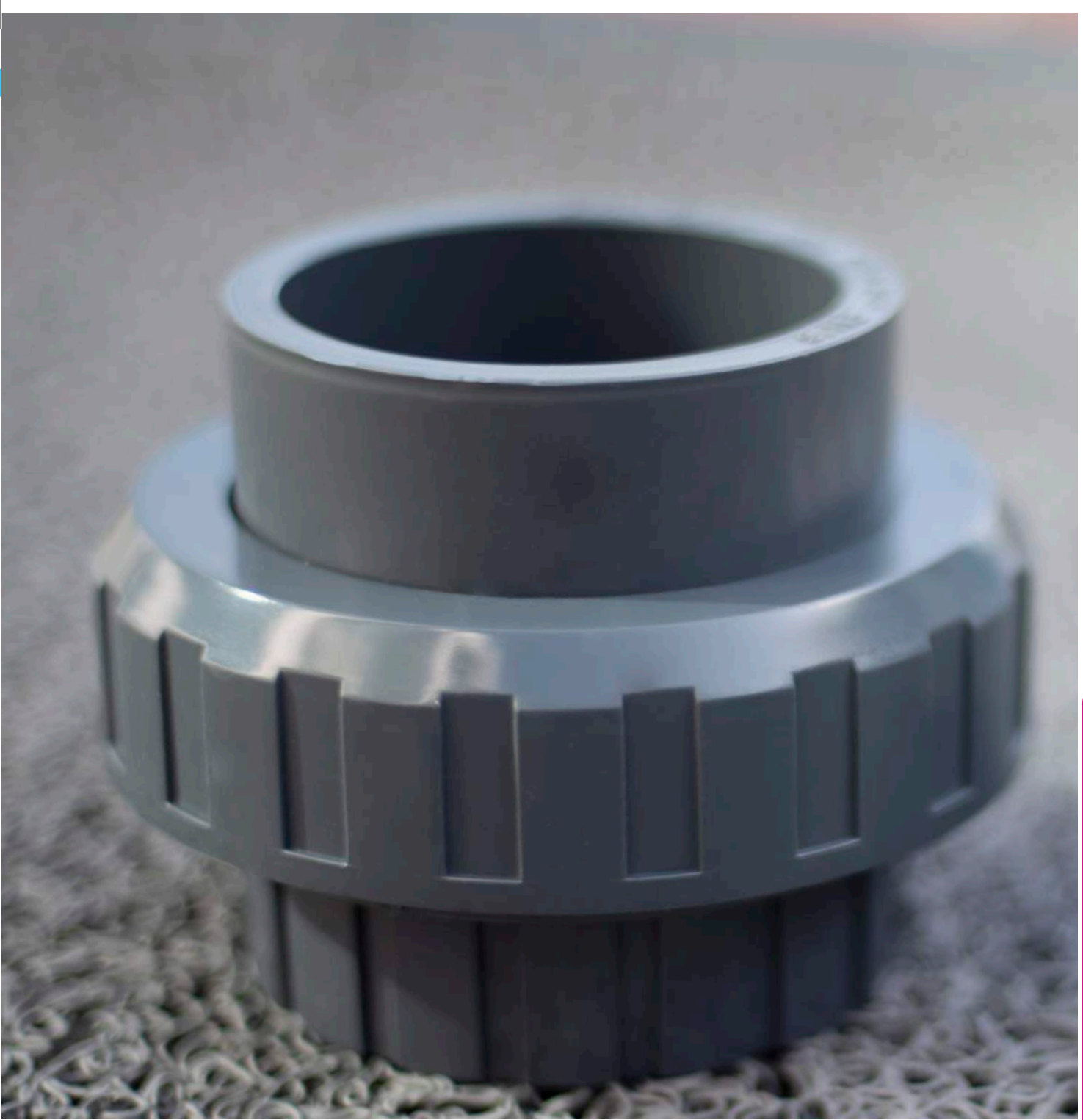

**U-PVC**

**RAKOR / UNION**

**ÜRETİM STANDARDI / PRODUCTION STANDARD**

**EN 1452-3**

**ÇAP / SIZE Ø20 - Ø110**

**UH-PVC Rakor**  
UH-PVC Union

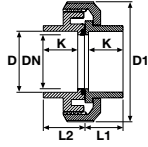

Su için / For Water

Asit için / For Acid

Çap Dia	Basınç PN	EPDM Conta Kod EPDM O-Ring Code	Fiyat (Adet) Price (Pcs)	EPDM Conta Kod EPDM O-Ring Code	Fiyat (Adet) Price (Pcs)	Kg /Adet Kg/Pcs	Koli/Ad. Box/Pcs	DN (mm)	D1 (mm)	L1 (mm)	L2 (mm)	K (mm)
16	16	227 00 016 2	1,85 €	227 55 016 2	2,40 €	0,05	125	12	53	19	24	16
20	16	227 00 020 2	1,35 €	227 55 020 2	1,75 €	0,05	125	15	54	19	24	16
25	16	227 00 025 2	1,90 €	227 55 025 2	2,47 €	0,07	100	20	62	22	27	19
32	16	227 00 032 2	2,60 €	227 55 032 2	3,38 €	0,09	50	25	65	25	30	22
40	16	227 00 040 2	2,85 €	227 55 040 2	3,70 €	0,16	30	32	83	28	36	26
50	16	227 00 050 2	3,90 €	227 55 050 2	5,07 €	0,189	45	40	93	38	42	31
63	16	227 00 063 2	4,60 €	227 55 063 2	5,98 €	0,35	25	50	116	41	52	38
75	16	227 00 075 2	12,00 €	227 55 075 2	15,60 €	0,585	18	65	129	47	54	44
90	16	227 00 090 2	16,50 €	227 55 090 2	21,45 €	0,98	10	80	155	56	61	51
110	16	227 00 110 2	21,50 €	227 55 110 2	28,00 €	1,47	7	100	178	66	71	61

**UH-PVC Tek Taraf İçten Dişli Rakor**  
UH-PVC One Side Female Threaded Union

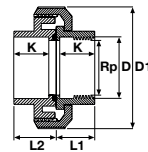

Su için / For Water

Asit için / For Acid

Çap Dia	Rp (Inch)	Basınç PN	EPDM Conta Kod EPDM O-Ring Code	Fiyat (Adet) Price (Pcs)	EPDM Conta Kod EPDM O-Ring Code	Fiyat (Adet) Price (Pcs)	Kg /Adet Kg/Pcs	Koli/Ad. Box/Pcs	DN (mm)	D1 (mm)	L1 (mm)	L2 (mm)	K (mm)
16	3/8"	16	228 00 016 2	2,50 €	228 55 016 2	3,25 €	0,05	125	12	53	19	24	16
20	1/2"	16	228 00 020 2	2,00 €	228 55 020 2	2,60 €	0,05	125	15	54	19	24	16
25	3/4"	16	228 00 025 2	2,60 €	228 55 025 2	3,38 €	0,07	100	20	62	22	27	19
32	1"	16	228 00 032 2	3,50 €	228 55 032 2	4,55 €	0,085	50	25	65	25	30	22
40	1 1/4"	16	228 00 040 2	3,80 €	228 55 040 2	4,94 €	0,155	30	32	83	28	36	26
50	1 1/2"	16	228 00 050 2	5,00 €	228 55 050 2	6,50 €	0,25	45	40	93	38	42	31
63	2"	16	228 00 063 2	6,00 €	228 55 063 2	7,80 €	0,48	25	50	116	41	52	38
75	2 1/2"	16	228 00 075 2	13,50 €	228 55 075 2	17,55 €	0,6	18	65	129	47	54	44
90	3"	16	228 00 090 2	18,00 €	228 55 090 2	23,40 €	1,005	10	80	155	56	61	51
110	4"	16	228 00 110 2	23,00 €	228 55 110 2	30,00 €	1,485	7	100	178	66	71	61

**UH-PVC Çift Taraf İçten Dişli Rakor**  
UH-PVC Both Sides Female Threaded Union

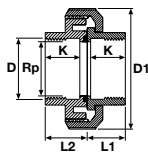

Su için / For Water

Asit için / For Acid

Rp (Inch)	Basınç PN	EPDM Conta Kod EPDM O-Ring Code	Fiyat (Adet) Price (Pcs)	EPDM Conta Kod EPDM O-Ring Code	Fiyat (Adet) Price (Pcs)	Kg /Adet Kg/Pcs	Koli/Ad. Box/Pcs	DN (mm)	D1 (mm)	L1 (mm)	L2 (mm)	K (mm)
3/8"	16	229 00 016 2	3,00 €	229 55 016 2	3,90 €	0,05	125	12	53	19	24	16
1/2"	16	229 00 020 2	2,50 €	229 55 020 2	3,25 €	0,05	125	15	54	19	24	16
3/4"	16	229 00 025 2	3,10 €	229 55 025 2	4,00 €	0,07	100	20	62	22	27	19
1"	16	229 00 032 2	4,10 €	229 55 032 2	5,30 €	0,09	50	25	65	25	30	22
1 1/4"	16	229 00 040 2	4,35 €	229 55 040 2	5,65 €	0,15	30	32	83	28	36	26
1 1/2"	16	229 00 050 2	5,90 €	229 55 050 2	7,67 €	0,25	45	40	93	38	42	31
2"	16	229 00 063 2	6,85 €	229 55 063 2	8,90 €	0,5	25	50	116	41	52	38
2 1/2"	16	229 00 075 2	14,20 €	229 55 075 2	18,46 €	0,61	18	65	129	47	54	44
3"	16	229 00 090 2	19,50 €	229 55 090 2	25,35 €	1,04	10	80	155	56	61	51
4"	16	229 00 110 2	24,90 €	229 55 110 2	32,37 €	1,415	7	100	178	66	71	61

**UH-PVC Pompa Rakoru Dış Diş**  
UH-PVC Male Threaded Union

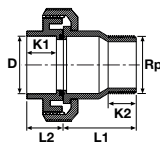

Su için / For Water

Asit için / For Acid

Çap Dia	Rp (Inch)	Basınç PN	EPDM Conta Kod EPDM O-Ring Code	Fiyat (Adet) Price (Pcs)	EPDM Conta Kod EPDM O-Ring Code	Fiyat (Adet) Price (Pcs)	Kg /Adet Kg/Pcs	Koli/Ad. Box/Pcs	DN (mm)	D1 (mm)	L1 (mm)	L2 (mm)	K1 (mm)	K2 (mm)
50	1 1/2"	16	230 00 050 2	4,10 €	230 55 050 2	5,33 €	0,23	45	40	50	81	45	31	22
63 x 50	1 1/2"	16	230 00 063 2	4,90 €	230 55 063 2	6,37 €	0,37	30	50	63	61	55	38	22
63	2"	16	230 01 063 2	4,95 €	230 56 063 2	6,45 €	0,39	25	50	63	72	55	38	27

### UH-PVC Rakor Dış Dış Piriç Çıkışlı

UH-PVC Union Outlet Male Threaded Brass

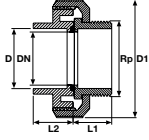

Çap Dia	Rp Inch	Basınç PN	EPDM Conta Kod EPDM O-Ring Code	Fiyat (Adet) Price (Pcs)	Kg /Adet Kg/Pcs	Koli/Adet Box/Pcs	DN (mm)	D1 (mm)	L1 (mm)	L2 (mm)
20	1/2"	16	242 30 020 2	2,76 €	0,105	125	15	15	19	25
25	3/4"	16	242 30 025 2	4,34 €	1	100	20	20	21	29
32	1"	16	242 30 032 2	5,77 €		50	25	25	25	32
40	1 1/4"	16	242 30 040 2	11,03 €	0,31	50	32	32	29	39
50	1 1/2"	16	242 30 050 2	14,89 €	0,455	30	40	40	34	45
63	2"	16	242 30 063 2	23,89 €	0,765	10	50	50	41	55

### Dış Dış Piriç Rakor UH-PVC Çıkışlı

Male Threaded Brass Union Outlet UH-PVC

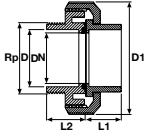

Çap Dia	Rp Inch	Basınç PN	EPDM Conta Kod EPDM O-Ring Code	Fiyat (Adet) Price (Pcs)	Kg /Adet Kg/Pcs	Koli/Adet Box/Pcs	DN (mm)	D1 (mm)	L1 (mm)	L2 (mm)
20	1/2"	16	242 00 020 2	3,34 €	0,08	125	15	36	19	14
25	3/4"	16	242 00 025 2	4,63 €	0,14	100	20	45	22	15
32	1"	16	242 00 032 2	5,93 €	0,17	50	25	51	25	17
40	1 1/4"	16	242 00 040 2	11,48 €	0,34	50	32	64	28	24
50	1 1/2"	16	242 00 050 2	17,27 €	0,52	30	40	80	38	22
63	2"	16	242 00 063 2	27,07 €	0,68	24	50	98	41	23



### UH-PVC Rakor İç Dış Piriç Çıkışlı

UH-PVC Union Outlet Female Threaded Brass

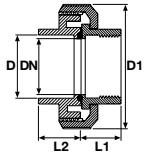

Çap Dia	R Inch	Basınç PN	EPDM Conta Kod EPDM O-Ring Code	Fiyat (Adet) Price (Pcs)	Kg /Adet Kg/Pcs	Koli/Adet Box/Pcs	DN (mm)	D1 (mm)	L1 (mm)	L2 (mm)
20	1/2"	16	242 20 020 2	2,50 €	0,09	125	15	36	19	14
25	3/4"	16	242 20 025 2	3,99 €	0,10	100	20	45	21	15
32	1"	16	242 20 032 2	5,16 €	0,15	50	25	51	25	17
40	1 1/4"	16	242 20 040 2	9,36 €	0,32	50	32	64	29	24
50	1 1/2"	16	242 20 050 2	13,24 €	0,39	30	40	80	34	22
63	2"	16	242 20 063 2	20,83 €	0,66	10	50	98	41	23

### İç Dış Piriç Rakor UH-PVC Çıkışlı

Female Threaded Brass Union Outlet UH-PVC

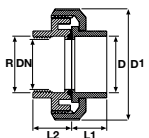

Çap Dia	R Inch	Basınç PN	EPDM Conta Kod EPDM O-Ring Code	Fiyat (Adet) Price (Pcs)	Kg /Adet Kg/Pcs	Koli/Adet Box/Pcs	DN (mm)	D1 (mm)	L1 (mm)	L2 (mm)
20	1/2"	16	242 10 020 2	3,06 €	0,07	50	15	36	19	14
25	3/4"	16	242 10 025 2	4,28 €	0,10	100	20	45	22	15
32	1"	16	242 10 032 2	5,32 €	0,15	90	25	51	25	17
40	1 1/4"	16	242 10 040 2	11,93 €	0,28	80	32	64	28	24
50	1 1/2"	16	242 10 050 2	15,61 €	0,41	30	40	80	38	22
63	2"	16	242 10 063 2	26,45 €	0,77	24	50	98	41	23

### UH-PVC Gözetleme Camı UH-PVC Inspection Glass

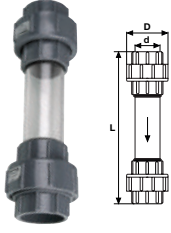

Çap Dia	Basınç PN	EPDM Conta Kod EPDM O-Ring Code	Fiyat (Adet) Price (Pcs)	Kg /Adet Kg/Pcs	Koli/Adet Box/Pcs	DN (mm)	D (mm)	L (mm)
20	10	231 00 020 2	15,40 €	0,13	100	15	51	205
25	10	231 00 025 2	16,80 €	0,18	100	20	57	219
32	10	231 00 032 2	18,20 €	0,31	50	25	67	230
40	10	231 00 040 2	19,60 €	0,43	50	32	82	244
50	10	231 00 050 2	21,00 €	0,53	30	40	88	272
63	10	231 00 063 2	23,80 €	0,91	25	50	107	368
75	10	231 00 075 2	60,20 €	1,39	10	63	131	320
90	10	231 00 090 2	81,20 €	2,27	5	80	147	351
110	10	231 00 110 2	89,60 €		2	100	176	420

### UH-PVC Gözetleme Camı (Flanş Bağlantılı) UH-PVC Inspection Glass (With Flange)

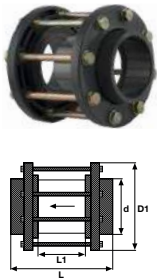
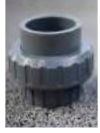

Çap Dia	Basınç PN	EPDM Conta Kod EPDM O-Ring Code	Fiyat (Adet) Price (Pcs)	Kg /Adet Kg/Pcs	Koli/Adet Box/Pcs	DN (mm)	D1 (mm)	L (mm)	L1 (mm)	nQe
125	10	231 00 125 2	112,00 €	6,29	1	110	250	254	110	8-Q16
140	10	231 00 140 2	126,00 €	6,75	1	125	250	265	110	8-Q16
160	10	231 00 160 2	189,00 €	10,7	2	150	285	315	110	8-Q20
200	10	231 00 200 2	224,00 €	14,5	1	175	340	315	80	8-Q20
225	10	231 00 225 2	266,00 €	14,7	1	200	340	315	80	8-Q20

### UH-PVC Seviye Göstergesi UH-PVC Variable Area Flow Meter

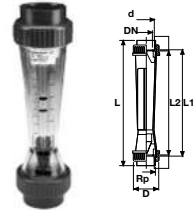

Çap Dia	EPDM Conta Kod EPDM O-Ring Code	Fiyat (Adet) Price (Pcs)	Kg/Adet Kg/Pcs	Koli/Adet Box/Pcs	DN (mm)	D (mm)	L (mm)	L1 (mm)	L2 (mm)	Rp (Inch)	ScaleRange (l/h)	Type
32	231 00 900 4	343,00 €	0,41	1	25	60	385	341	335	1"	50 - 500	SK 10
32	231 00 902 4	343,00 €	0,41	1	25	60	385	341	335	1"	100 - 1000	SK 11
32	231 00 734 4	343,00 €	0,41	1	25	60	385	341	335	1"	150 - 1500	SK 12
50	231 00 738 4	457,00 €	1,02	1	40	83	403	341	335	1 1/2"	200 - 2000	SK 18
50	231 00 741 4	457,00 €	1,02	1	40	83	403	341	335	1 1/2"	250 - 2500	SK 19
50	231 00 904 4	457,00 €	1,02	1	40	83	403	341	335	1 1/2"	300 - 3000	SK 20
50	231 00 906 4	457,00 €	1,02	1	40	83	403	341	335	1 1/2"	600 - 6000	SK 21
63	231 00 744 4	732,00 €	1,38	1	50	103	417	341	335	2"	600 - 6000	SK 29
63	231 00 908 4	732,00 €	1,38	1	50	103	417	341	335	2"	1000 - 10000	SK 30
63	231 00 910 4	732,00 €	1,38	1	50	103	417	341	335	2"	1500 - 15000	SK 31
75	231 00 330 4	1,138,00 €	2,15	1	65	122	457	342	335	2 1/2"	2000 - 20000	SK 40
75	231 00 332 4	1,138,00 €	2,15	1	65	122	457	342	335	2 1/2"	3000 - 30000	SK 41

### UH-PVC Temizleme Y. Filtresi UH-PVC Line Strainer (Transparent Body)

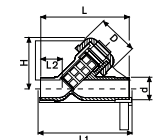

Çap Dia	Basınç PN	EPDM Conta Kod EPDM O-Ring Code	Fiyat (Adet) Price (Pcs)	Kg/Adet Kg/Pcs	Koli/Adet Box/Pcs	DN (mm)	D (mm)	L (mm)	L1 (mm)	L2 (mm)
20	10	231 00 300 4	99,00 €	0,11	1	15	43	124	130	28
25	10	231 00 350 4	106,20 €	0,17	1	20	47	144	150	37
32	10	231 00 400 4	122,40 €	0,22	1	25	56	154	160	37
40	10	231 00 450 4	154,80 €	0,38	1	32	64	174	180	44
50	10	231 00 500 4	212,40 €	0,63	1	40	82	194	200	48
63	10	231 00 550 4	252,00 €	1,05	1	50	95	224	230	60
75	10	231 00 600 4	405,00 €	1,83	1	65	106	284	290	74
90	10	231 00 650 4	473,40 €	2,56	1	80	120	300	310	85

### Metal Körüklü Kompansatörler / Hareketli Flanş (30 mm Layersiz)

*Metal Bellows Compensator / Moving Flange (30 mm Without Liner)*



Çap Dia	Kod Code	Fiyat (Adet) Price (Pcs)	Kg /Adet Kg/Pcs
40	120 12 040 8	75,00 €	
50	120 12 050 8	80,00 €	3,79
63	120 12 063 8	85,00 €	4,80
75	120 12 075 8	103,00 €	5,60
90	120 12 090 8	124,00 €	
110	120 12 110 8	155,00 €	8,20
140	120 12 140 8	180,00 €	9,80
160	120 12 160 8	230,00 €	12,4
225	120 12 225 8	375,00 €	20,3
280	120 12 280 8	505,00 €	24,8
315	120 12 315 8	710,00 €	35,0

### Metal Körüklü Kompansatörler / Hareketli Flanş (30 mm Laynerli)

*Metal Bellows Compensator / Moving Flange (30 mm With Liner)*



Çap Dia	Kod Code	Fiyat (Adet) Price (Pcs)	Kg /Adet Kg/Pcs
40	120 13 040 8	93,00 €	
50	120 13 050 8	105,00 €	4,10
63	120 13 063 8	115,00 €	5,20
75	120 13 075 8	135,00 €	6,20
90	120 13 090 8	160,00 €	7,00
110	120 13 110 8	195,00 €	8,00
140	120 13 140 8	230,00 €	12,2
160	120 13 160 8	270,00 €	13,8
225	120 13 225 8	385,00 €	17,4
280	120 13 280 8	525,00 €	26,0



### Kauçuk Kompansatörler

*Rubber Compensator*



Çap Dia	Kod Code	Fiyat (Adet) Price (Pcs)	Kg /Adet Kg/Pcs
40	120 10 040 8	45,00 €	3,00
50	120 10 050 8	47,50 €	3,80
63	120 10 063 8	53,00 €	4,50
75	120 10 075 8	71,00 €	5,20
90	120 10 090 8	81,00 €	6,70
110	120 10 110 8	100,00 €	7,80
140	120 10 140 8	125,00 €	9,60
160	120 10 160 8	170,00 €	11,8
225	120 10 225 8	240,00 €	16,8
280	120 10 280 8	330,00 €	20,0
315	120 10 315 8	545,00 €	28,0
355	120 10 355 8	1,272,00 €	42,4
400	120 10 400 8	2,550,00 €	46,0

### Kauçuk Kompansatörler / Rakor Bağlantılı

*Rubber Compensator With Union Connection*



Çap Dia	Kod Code	Fiyat (Adet) Price (Pcs)	Kg /Adet Kg/Pcs
40	120 11 040 8	35,00 €	1,4
50	120 11 050 8	45,00 €	2
63	120 11 063 8	53,00 €	2,6
75	120 11 075 8	84,00 €	4
90	120 11 090 8	112,00 €	5,6







**U-PVC**  
**KÜRESEL VANA**  
BALL VALVE

ÜRETİM STANDARDI / PRODUCTION STANDARD

TS EN ISO 16135  
ÇAP / SIZE Ø20 - Ø110

**U-PVC Yapıştırma Mufllu Küresel Su Vanası**  
U-PVC Solvent Cement True Union Ball Valve For Water

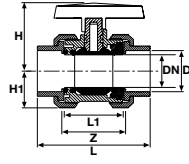

Çap Dia	Basınç PN	EPDM Conta Kod EPDM O-Ring Code	Fiyat (Adet) Price (Pcs)	Kg/Adet Kg/Pcs	Koli/Adet Box/Pcs	DN (mm)	kv l/min	Z (mm)	L1 (mm)	L (mm)	H (mm)	H1 (mm)
16	16	202 00 016 2	6,30 €	1	55	12	70	50	42	80	47	27
20	16	202 00 020 2	5,20 €	0,14	55	15	185	52	45	85	47	27
25	16	202 00 025 2	5,50 €	0,18	75	20	350	58	49	95	51	31
32	16	202 00 032 2	6,50 €	0,25	60	25	700	61	54	107	63	33
40	16	202 00 040 2	7,00 €	0,43	30	32	1000	73	66	128	67	41
50	16	202 00 050 2	8,20 €	0,65	20	40	1600	82	75	154	86	46
63	16	202 00 063 2	10,80 €	1,13	12	50	3100	95	89	172	101	58
75	16	202 00 075 2	28,00 €	1,47	5	65	5000	118	111	196	110	73
90	16	202 00 090 2	37,00 €	3,58	4	80	7000	139	126	241	137	89
110	16	202 00 110 2	55,00 €	5,43	2	100	11000	165	153	289	150	105

**U-PVC Küresel Su Vanası Tek Taraf İçten Dişli**  
U-PVC One Side Female Threaded True Union Ball Valve For Water

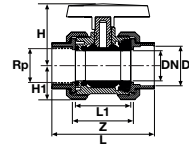

Çap Dia	Rp (Inch)	Basınç PN	EPDM Conta Kod EPDM O-Ring Code	Fiyat (Adet) Price (Pcs)	Kg/Adet Kg/Pcs	Koli/Adet Box/Pcs	DN (mm)	kv l/min	Z (mm)	L1 (mm)	L (mm)	H (mm)	H1 (mm)
16	3/8"	16	203 00 016 2	7,20 €	0	55	12	70	50	42	80	47	27
20	1/2"	16	203 00 020 2	6,10 €	0,14	55	15	185	52	45	85	47	27
25	3/4"	16	203 00 025 2	6,50 €	0,19	75	20	350	58	49	95	51	31
32	1"	16	203 00 032 2	7,80 €	0,24	60	25	700	61	54	107	63	33
40	1 1/4"	16	203 00 040 2	8,30 €	0,42	30	32	1000	73	66	128	67	41
50	1 1/2"	16	203 00 050 2	9,50 €	0,66	20	40	1600	82	75	154	86	46
63	2"	16	203 00 063 2	12,10 €	1,17	12	50	3100	95	89	172	101	58
75	2 1/2"	16	203 00 075 2	30,00 €	1,48	9	65	5000	118	111	196	110	73
90	3"	16	203 00 090 2	39,00 €	3,56	4	80	7000	139	126	241	137	89
110	4"	16	203 00 110 2	58,00 €	5,35	2	100	11000	165	153	289	150	105

**U-PVC Küresel Su Vanası Çift Taraf İçten Dişli**  
U-PVC Both Sides Female Threaded True Union Ball Valve For Water

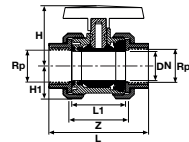

Çap Dia	Rp (Inch)	Basınç PN	EPDM Conta Kod EPDM O-Ring Code	Fiyat (Adet) Price (Pcs)	Kg/Adet Kg/Pcs	Koli/Adet Box/Pcs	DN (mm)	kv l/min	Z (mm)	L1 (mm)	L (mm)	H (mm)	H1 (mm)
16	3/8"	16	204 00 016 2	8,10 €	0,19	55	12	70	50	42	80	47	27
20	1/2"	16	204 00 020 2	7,00 €	0,14	55	15	185	52	45	85	47	27
25	3/4"	16	204 00 025 2	7,40 €	0,19	75	20	350	58	49	95	51	31
32	1"	16	204 00 032 2	8,90 €	0,24	60	25	700	61	54	107	63	33
40	1 1/4"	16	204 00 040 2	9,40 €	0,42	30	32	1000	73	66	128	67	41
50	1 1/2"	16	204 00 050 2	10,80 €	0,66	20	40	1600	82	75	154	86	46
63	2"	16	204 00 063 2	13,40 €	1,17	12	50	3100	95	89	172	101	58
75	2 1/2"	16	204 00 075 2	32,00 €	1,48	9	65	5000	118	111	196	110	73
90	3"	16	204 00 090 2	41,00 €	3,56	4	80	7000	139	126	241	137	89
110	4"	16	204 00 110 2	61,00 €	5,35	2	100	11000	165	153	289	150	105

## U-PVC Küresel Su Vanası Çift Taraf Flanş Bağlantılı

### U-PVC Both Sides Female Threaded Ball Valve For Water

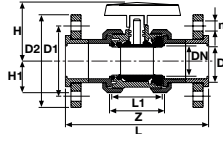

Çap Dia	Basınç PN	EPDM Conta Kod EPDM O-Ring Code	Fiyat (Adet) Price (Pcs)	Kg/Adet Kg/Pcs	Koli/Adet Box/Pcs	DN (mm)	kv l/min	Z (mm)	L1 (mm)	L (mm)	H (mm)	H1 (mm)	D1 (mm)	D2 (mm)	n (mmxAdet)
20	16	208 00 020 2	16,30 €	0,36	40	15	185	52	45	123	47	27	65	95	14 x 4
25	16	208 00 025 2	17,40 €	0,47	30	20	350	58	49	140	51	31	75	105	14 x 4
32	16	208 00 032 2	18,35 €	0,66	25	25	700	61	54	158	63	33	85	115	14 x 4
40	16	208 00 040 2	19,50 €	1,08	20	32	1000	73	66	186	67	42	100	140	18 x 4
50	16	208 00 050 2	24,00 €	1,44	10	40	1600	82	75	231	86	46	110	150	18 x 4
63	16	208 00 063 2	26,50 €	2,29	10	50	3100	95	89	253	101	58	125	165	18 x 4
75	16	208 00 075 2	52,00 €	2,99	4	65	5000	118	111	291	110	73	145	185	18 x 4
90	16	208 00 090 2	62,50 €	5,7	2	80	7000	139	126	353	137	90	160	200	18 x 8
110	16	208 00 110 2	104,70 €	8,05	1	100	11000	165	153	431	150	106	180	220	18 x 8

## U-PVC Üç Yollu Küresel Vana (T Port)

### U-PVC Three Ways Ball Valve (T Port)

NEW

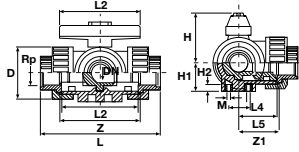

Çap Dia	Basınç PN	Kod Code	Fiyat (Adet) Price (Pcs)	Kg/Adet Kg/Pcs	Koli/Adet Box/Pcs	D (mm)	L (mm)	L1 (mm)	L2 (mm)	L3 (mm)	L4 (mm)	L5 (mm)	L6 (mm)	L7 (mm)	H (mm)
20	10	210 01 020 4	☎	0,25	55	45	134	78	72	139	25	36	67	70	50
25	10	210 01 025 4	☎	0,36	75	53	156	92	86	161	25	43	78	81	60
32	10	210 01 032 4	☎	0,54	60	65	172	100	96	177	25	48	86	89	68
40	10	210 01 040 4	☎	0,93	30	78	202	110	116	207	45	58	101	104	79
50	10	210 01 050 4	☎	1,36	20	92	238	120	137	242	45	69	119	121	90
63	10	210 01 063 4	☎	2,66	12	116	290	146	179	294	45	90	145	147	109
75	10	210 01 075 4	☎												
90	10	210 01 090 4	☎												
110	10	210 01 110 4	☎												

## U-PVC Üç Yollu Üç Tarafı İçten Dişli Küresel Vana (T Port)

### U-PVC Three Ways Female Threaded Ball Valve (T Port)

NEW

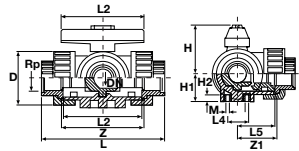

Çap Dia	Basınç PN	Kod Code	Fiyat (Adet) Price (Pcs)	Kg/Adet Kg/Pcs	Koli/Adet Box/Pcs	D (mm)	L (mm)	L1 (mm)	L2 (mm)	L4 (mm)	L5 (mm)	H (mm)	H1 (mm)
20	10	211 00 020 4	☎	0,25	55	45	111	78	72	25	36	50	27
25	10	211 00 025 4	☎	0,36	75	53	131	92	86	25	43	60	33
32	10	211 00 032 4	☎	0,54	60	65	148	100	96	25	48	68	36
40	10	211 00 040 4	☎	0,93	30	78	176	110	116	45	58	79	44
50	10	211 00 050 4	☎	1,4	20	92	206	120	137	45	69	90	49
63	10	211 00 063 4	☎	2,66	12	116	262	146	179	45	90	109	61
75	10	211 00 075 4	☎										
90	10	211 00 090 4	☎										
110	10	211 00 110 4	☎										

### U-PVC Yapıştırma Mufllu Küresel Su Vanası (Pozisyon Ayarlı)

U-PVC Solvent Cement True Union Ball Valve Position Regulated For Water

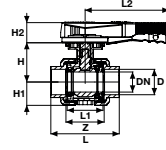

Çap Dia	Basınç PN	EPDM Conta Kod EPDM O-Ring Code	Fiyat (Adet) Price (Pcs)	Kg/Adet Kg/Pcs	Koli/Adet Box/Pcs	DN (mm)	Z (mm)	L1 (mm)	L2 (mm)	L (mm)	H (mm)	H1 (mm)	H2 (mm)	kv l/min
63	16	202 10 063 2	16,20 €	1,16	12	50	95	89	207,5	172	101	58	48	3100
75	16	202 10 075 2	42,00 €	1,45	9	65	118	111	207,5	196	110	73	50	5000
90	16	202 10 090 2	55,50 €	3,51	4	80	139	126	207,5	241	137	89	52	7000
110	16	202 10 110 2	82,50 €	5,40	2	100	165	153	259,5	289	150	105	52	11000

### U-PVC Yapıştırma Mufllu Küresel Su Vanası Tek Taraf İçten Dişli (Pozisyon Ayarlı)

U-PVC True Union Ball Valves Position Regulated For Water One Side Female Threaded

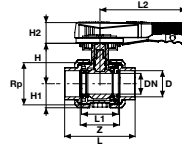

Çap Dia	Rp (Inch)	Basınç PN	EPDM Conta Kod EPDM O-Ring Code	Fiyat (Adet) Price (Pcs)	Kg/Adet Kg/Pcs	Koli/Adet Box/Pcs	DN (mm)	Z (mm)	L1 (mm)	L2 (mm)	L (mm)	H (mm)	H1 (mm)	H2 (mm)	kv l/min
63	2"	16	203 10 063 2	18,15 €	1,16	12	50	95	89	207,5	172	101	58	48	3100
75	2 1/2"	16	203 10 075 2	45,00 €	1,45	9	65	118	111	207,5	196	110	73	50	5000
90	3"	16	203 10 090 2	58,50 €	3,51	4	80	139	126	207,5	241	137	89	52	7000
110	4"	16	203 10 110 2	87,00 €	5,40	2	100	165	153	259,5	289	150	105	52	11000

### U-PVC Küresel Su Vanası Çift Taraf İçten Dişli (Pozisyon Ayarlı)

U-PVC True Union Ball Valves Position Regulated For Water One Side Female Threaded

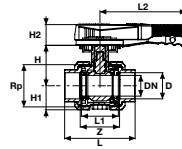

Çap Dia	Rp (Inch)	Basınç PN	EPDM Conta Kod EPDM O-Ring Code	Fiyat (Adet) Price (Pcs)	Kg/Adet Kg/Pcs	Koli/Adet Box/Pcs	DN (mm)	Z (mm)	L1 (mm)	L2 (mm)	L (mm)	H (mm)	H1 (mm)	H2 (mm)	kv l/min
63	2"	16	204 10 063 2	20,10 €	1,16	12	50	95	89	207,5	172	101	58	48	3100
75	2 1/2"	16	204 10 075 2	48,00 €	1,45	9	65	118	111	207,5	196	110	73	50	5000
90	3"	16	204 10 090 2	61,50 €	3,51	4	80	139	126	207,5	241	137	89	52	7000
110	4"	16	204 10 110 2	91,50 €	5,40	2	100	165	153	259,5	289	150	105	52	11000

## U-PVC Küresel Su Vanası Çift Taraf Flanş Bağlantılı (Pozisyon Ayarlı)

U-PVC Solvent Cement Both Sides Flanged True Union Ball Valve Position Regulated For Water

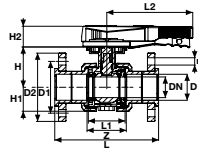
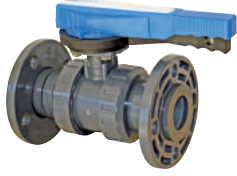

Çap Dia	Basınç PN	EPDM Conta Kod EPDM O-Ring Code	Fiyat (Adet) Price (Pcs)	Kg/Adet Kg/Pcs	Koli/Adet Box/Pcs	DN (mm)	Z (mm)	L1 (mm)	L2 (mm)	L (mm)	H (mm)	H1 (mm)	H2 (mm)	D1 (mm)	D2 (mm)	n (mm)	kv l/min
63	16	208 10 063 2	39,75 €	0,36	12	50	95	89	207,5	253	101	58	48	125	165	18x4	3100
75	16	208 10 075 2	78,00 €	0,47	9	65	118	111	207,5	291	110	64	50	145	185	22x4	5000
90	16	208 10 090 2	93,75 €	0,66	4	80	139	126	207,5	353	137	90	52	160	200	22x8	7000
110	16	208 10 110 2	157,05 €	1,08	2	100	165	153	259,5	431	150	106	52	180	220	24x8	11000



### U-PVC Yapıştırma Muflu Küresel Su Vanası (Tek Tarafı Piriç İç Diş)

U-PVC One Side Brass Female Threaded Solvent Cement True Union Ball Valve For Water

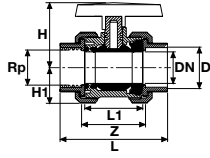

Çap Dia	Rp (Inch)	Basınç PN	Kod Code	Fiyat (Adet) Price (Pcs)	Kg/Adet Kg/Pcs	Koli/Adet Box/Pcs	DN (mm)	kv l/min	Z (mm)	L1 (mm)	L (mm)	H (mm)	H1 (mm)
20	1/2"	16	243 00 020 2	8,49 €	0,18	55	15	185	52	45	86	47	27
25	3/4"	16	243 00 025 2	10,61 €	0,24	75	20	350	58	49	96	51	31
32	1"	16	243 00 032 2	12,68 €	0,31	60	25	700	61	54	106	63	33
40	1 1/4"	16	243 00 040 2	19,32 €	0,50	30	32	1000	73	66	127	67	42
50	1 1/2"	16	243 00 050 2	28,58 €	0,80	20	40	1600	82	75	153	86	46
63	2"	16	243 00 063 2	40,75 €	1,36	12	50	3100	95	89	172	101	58

### U-PVC İç Dişli Küresel Su Vanası (Tek Tarafı Piriç İç Diş)

U-PVC One Side Brass Female Threaded Other Side Female Threaded True Union Ball Valve For Water

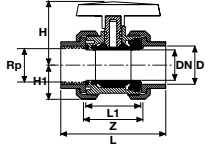

Çap Dia	Rp (Inch)	Basınç PN	Kod Code	Fiyat (Adet) Price (Pcs)	Kg/Adet Kg/Pcs	Koli/Adet Box/Pcs	DN (mm)	kv l/min	Z (mm)	L1 (mm)	L (mm)	H (mm)	H1 (mm)
20	1/2"	16	244 00 020 2	9,39 €	0,20	55	15	185	52	45	86	47	27
25	3/4"	16	244 00 025 2	11,61 €	0,35	75	20	350	58	49	96	51	31
32	1"	16	244 00 032 2	13,98 €	0,31	60	25	700	61	54	106	63	33
40	1 1/4"	16	244 00 040 2	20,62 €		30	32	1000	73	66	127	67	42
50	1 1/2"	16	244 00 050 2	29,88 €		20	40	1600	82	75	153	86	46
63	2"	16	244 00 063 2	42,05 €	1,53	12	50	3100	95	89	172	101	58

### U-PVC Küresel Su Vanası (Çift Tarafı Piriç İç Diş)

U-PVC Both Sides Brass Female Threaded True Union Ball Valve For Water

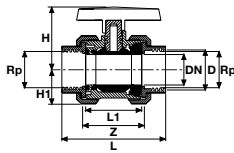

Çap Dia	Rp (Inch)	Basınç PN	Kod Code	Fiyat (Adet) Price (Pcs)	Kg/Adet Kg/Pcs	Koli/Adet Box/Pcs	DN (mm)	kv l/min	Z (mm)	L1 (mm)	L (mm)	H (mm)	H1 (mm)
20	1/2"	16	244 10 020 2	10,32 €	0,20	55	15	185	52	45	86	47	27
25	3/4"	16	244 10 025 2	12,77 €	0,35	75	20	350	58	49	96	51	31
32	1"	16	244 10 032 2	15,37 €	0,31	60	25	700	61	54	106	63	33
40	1 1/4"	16	244 10 040 2	22,68 €		30	32	1000	73	66	127	67	42
50	1 1/2"	16	244 10 050 2	32,86 €	1	20	40	1600	82	75	153	86	46
63	2"	16	244 10 063 2	46,25 €	1,53	12	50	3100	95	89	172	101	58

### U-PVC Küresel Su Vanası (Tek Tarafı Pirinç Dış Diş)

U-PVC One Side Brass Male Threaded Solvent Cement True Union Ball Valve For Water

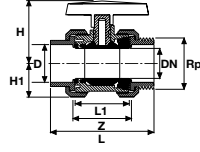

Çap Dia	Rp (Inch)	Basınç PN	Kod Code	Fiyat (Adet) Price (Pcs)	Kg/Adet Kg/Pcs	Koli/Adet Box/Pcs	DN (mm)	kv l/min	Z (mm)	L1 (mm)	L (mm)	H (mm)	H1 (mm)
20	1/2"	16	243 20 020 2	9,07 €	0,19	55	15	185	52	45	112	47	27
25	3/4"	16	243 20 025 2	11,35 €	0,26	75	20	350	58	49	113	51	31
32	1"	16	243 20 032 2	13,98 €	0,34	60	25	700	61	54	136	63	33
40	1 1/4"	16	243 20 040 2	22,30 €	0,57	30	32	1000	73	66	158	67	42
50	1 1/2"	16	243 20 050 2	32,15 €	0,86	20	40	1600	82	75	173	86	46
63	2"	16	243 20 063 2	46,36 €	1,45	12	50	3100	95	89	203	101	58

### U-PVC İç Diş Küresel Su Vanası (Tek Taraf Pirinç Dış Diş)

U-PVC One Side Female Threaded Other Side Brass Male Threaded True Union Ball Valve For Water

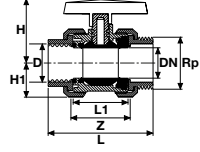

Çap Dia	Rp (Inch)	Basınç PN	Kod Code	Fiyat (Adet) Price (Pcs)	Kg/Adet Kg/Pcs	Koli/Adet Box/Pcs	DN (mm)	kv l/min	Z (mm)	L1 (mm)	L (mm)	H (mm)	H1 (mm)
20	1/2"	16	244 20 020 2	9,97 €	0,19	55	15	185	52	45	112	47	27
25	3/4"	16	244 20 025 2	12,35 €	0,26	75	20	350	58	49	113	51	31
32	1"	16	244 20 032 2	15,28 €	0,34	60	25	700	61	54	136	63	33
40	1 1/4"	16	244 20 040 2	23,60 €	0,57	30	32	1000	73	66	158	67	42
50	1 1/2"	16	244 20 050 2	33,45 €	0,87	20	40	1600	82	75	173	86	46
63	2"	16	244 20 063 2	47,66 €	1,48	12	50	3100	95	89	203	101	58

### U-PVC Küresel Su Vanası (Tek Tarafı İç Diş Tek Tarafı Pirinç Dış Diş)

U-PVC One Side Brass Female Threaded One Side Brass Male Threaded True Union Ball Valve For Water

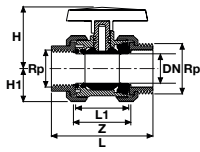

Çap Dia	Rp (Inch)	Basınç PN	Kod Code	Fiyat (Adet) Price (Pcs)	Kg/Adet Kg/Pcs	Koli/Adet Box/Pcs	DN (mm)	kv l/min	Z (mm)	L1 (mm)	L (mm)	H (mm)	H1 (mm)
20	1/2"	16	245 20 020 2	14,00 €	0,21	55	15	185	52	45	112	47	27
25	3/4"	16	245 20 025 2	17,00 €	0,36	75	20	350	58	49	113	51	31
32	1"	16	245 20 032 2	20,00 €	0,33	60	25	700	61	54	136	63	33
40	1 1/4"	16	245 20 040 2	28,00 €	0,66	30	32	1000	73	66	158	67	42
50	1 1/2"	16	245 20 050 2	42,80 €	0,96	20	40	1600	82	75	173	86	46
63	2"	16	245 20 063 2	59,00 €	1,62	12	50	3100	95	89	203	101	58

### U-PVC Tek Taraflı Küresel Vana Çift Taraflı Yapıştırma

U-PVC Solvent Cement Single Union Ball Valve Both Side Solvent Cement Socketed

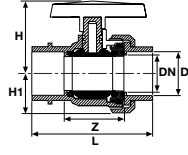

Çap Dia	Basınç PN	EPDM Conta Kod EPDM O-Ring Code	Fiyat (Adet) Price (Pcs)	Kg/Adet Kg/Pcs	Koli/Adet Box/Pcs	DN (mm)	Z (mm)	L (mm)	H (mm)	H1 (mm)
20	16	232 00 020 2	4,42 €	0,10	55	15	52	78	47	27
25	16	232 00 025 2	4,68 €	0,13	56	20	58	87	52	31
32	16	232 00 032 2	5,53 €	0,19	60	25	61	100	63	33
40	16	232 00 040 2	5,95 €	0,30	30	32	73	114	66	42
50	16	232 00 050 2	6,97 €	0,51	20	40	82	146	89	41
63	16	232 00 063 2	9,18 €	0,90	12	50	95	160	100	58
75	16	232 00 075 2	23,80 €	1,19	9	65	118	195	110	65
90	16	232 00 090 2	31,45 €	2,78	4	80	139	228	137	89
110	16	232 00 110 2	46,75 €	4,47	2	100	165	275	150	105

### U-PVC Y.M. Küresel Tek Taraflı Vana Tek Taraf İçten Dişli

U-PVC Solvent Cement One Side Female Threaded Single Union Ball Valve

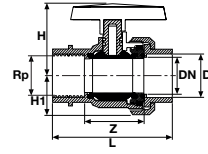

Çap Dia	Rp (Inch)	Basınç PN	EPDM Conta Kod EPDM O-Ring Code	Fiyat (Adet) Price (Pcs)	Kg/Adet Kg/Pcs	Koli/Adet Box/Pcs	DN (mm)	Z (mm)	L (mm)	H (mm)	H1 (mm)
20	1/2"	16	232 20 020 2	5,30 €	0,10	55	15	52	78	47	27
25	3/4"	16	232 20 025 2	5,65 €	0,14	56	20	58	87	52	31
32	1"	16	232 20 032 2	6,78 €	0,19	60	25	61	100	63	33
40	1 1/4"	16	232 20 040 2	7,22 €	0,31	30	32	73	114	66	42
50	1 1/2"	16	232 20 050 2	8,26 €	0,50	20	40	82	146	89	41
63	2"	16	232 20 063 2	10,52 €	0,91	12	50	95	160	100	58
75	2 1/2"	16	232 20 075 2	26,09 €	1,12	9	65	118	195	110	65
90	3"	16	232 20 090 2	33,91 €	2,82	4	80	139	228	137	89
110	4"	16	232 20 110 2	50,43 €	4,30	2	100	165	275	150	105

### U-PVC Y.M. Küresel Tek Taraflı Vana Çift Taraf İçten Dişli

U-PVC Solvent Cement Both Sides Female Threaded Single Union Ball Valve

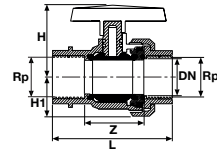

Rp (Inch)	Basınç PN	EPDM Conta Kod EPDM O-Ring Code	Fiyat (Adet) Price (Pcs)	Kg/Adet Kg/Pcs	Koli/Adet Box/Pcs	DN (mm)	Z (mm)	L (mm)	H (mm)	H1 (mm)
1/2"	16	232 40 020 2	6,09 €	0,10	55	15	52	78	47	27
3/4"	16	232 40 025 2	6,43 €	0,14	56	20	58	87	52	31
1"	16	232 40 032 2	7,74 €	0,19	60	25	61	100	63	33
1 1/4"	16	232 40 040 2	8,17 €	0,30	30	32	73	114	66	42
1 1/2"	16	232 40 050 2	9,39 €	0,51	20	40	82	146	89	41
2"	16	232 40 063 2	11,65 €	0,91	12	50	95	160	100	58
2 1/2"	16	232 40 075 2	27,83 €	1,22	9	65	118	195	110	65
3"	16	232 40 090 2	35,65 €	2,82	4	80	139	228	137	89
4"	16	232 40 110 2	53,04 €	4,37	2	100	165	275	150	105



### U-PVC Y.M. Küresel Tek Taraflı Vana Tek Taraf Dıştan Dişli

U-PVC Solvent Cement One Side Male Threaded Single Union Ball Valve

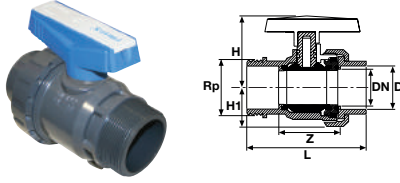

Çap Dia	Rp (Inch)	Basınç PN	EPDM Conta Kod EPDM O-Ring Code	Fiyat (Adet) Price (Pcs)	Kg/Adet Kg/Pcs	Koli/Adet Box/Pcs	DN (mm)	Z (mm)	L (mm)	H (mm)	H1 (mm)
20	1/2"	16	232 60 020 2	5,30 €	0,11	55	15	50	82	47	27
25	3/4"	16	232 60 025 2	5,65 €	0,14	56	20	52	92	52	31
32	1"	16	232 60 032 2	6,78 €	0,19	60	25	58	105	63	33
40	1 1/4"	16	232 60 040 2	7,22 €	0,31	30	32	73	125	66	42
50	1 1/2"	16	232 60 050 2	8,26 €	0,52	20	40	82	146	89	41
63	2"	16	232 60 063 2	10,52 €	0,90	12	50	95	160	100	58
75	2 1/2"	16	232 60 075 2	26,09 €		9	65	118	195	110	65
90	3"	16	232 60 090 2	33,91 €		4	80	139	228	137	89
110	4"	16	232 60 110 2	50,43 €		2	100	165	275	150	105

### U-PVC Küresel Tek Taraflı Vana Tek Taraf İçten Dişli Tek Taraf Dış Dişli

U-PVC One Side Female Threaded Other Side Male Threaded Single Union Ball Valve

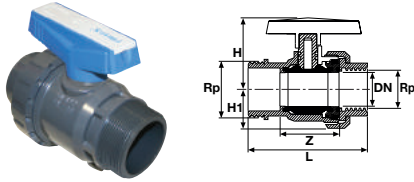

Çap Dia	Rp (Inch)	Basınç PN	EPDM Conta Kod EPDM O-Ring Code	Fiyat (Adet) Price (Pcs)	Kg/Adet Kg/Pcs	Koli/Adet Box/Pcs	DN (mm)	Z (mm)	L (mm)	H (mm)	H1 (mm)
20	1/2"	16	232 80 020 2	6,09 €	0,10	55	15	50	85	47	27
25	3/4"	16	232 80 025 2	6,43 €	0,14	56	20	52	92	52	31
32	1"	16	232 80 032 2	7,74 €	0,19	60	25	58	107	63	33
40	1 1/4"	16	232 80 040 2	8,17 €	0,31	30	32	73	114	66	42
50	1 1/2"	16	232 80 050 2	9,39 €	0,52	20	40	82	140	89	41
63	2"	16	232 80 063 2	11,65 €	0,92	12	50	95	163	100	58
75	2 1/2"	16	232 80 075 2	27,83 €		9	65	118	195	110	65
90	3"	16	232 80 090 2	35,65 €		4	80	139	228	137	89
110	4"	16	232 80 110 2	53,04 €		2	100	165	275	150	105

### U-PVC Yapıştırma Mufllu Küresel Tek Taraflı Vana Tek Taraf Flanş Çıkışlı

U-PVC Solvent Cement Single Union Ball Valve One Side Flanged

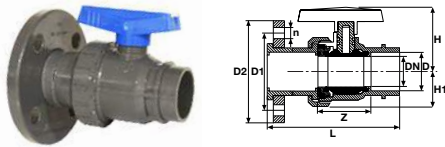

Çap Dia	Basınç PN	EPDM Conta Kod EPDM O-Ring Code	Fiyat (Adet) Price (Pcs)	Kg/Adet Kg/Pcs	Koli/Adet Box/Pcs	DN (mm)	Z (mm)	L (mm)	H (mm)	H1 (mm)	D1 (mm)	D2 (mm)	n (mm)	kv l/min
20	16	232 10 020 2	6,13 €		55	15	52	101	47	27	65	96	14x4	185
25	16	232 10 025 2	6,41 €		56	20	58	114	51	31	75	105	14x4	350
32	16	232 10 032 2	7,51 €		60	25	61	129	63	33	85	115	14x4	700
40	16	232 10 040 2	8,20 €		30	32	73	150	67	42	100	140	14x4	1000
50	16	232 10 050 2	9,32 €		24	40	82	188	86	46	100	150	18x4	1600
63	16	232 10 063 2	9,48 €		12	50	95	206	101	58	125	165	18x4	3100
75	16	232 10 075 2	28,55 €		9	65	118	242	110	64	145	185	22x4	5000
90	16	232 10 090 2	37,24 €		4	80	139	290	137	90	160	200	22x8	7000
110	16	232 10 110 2	54,23 €		2	100	165	353	150	106	180	220	24x8	11000

**U-PVC Y.M. Küresel Asit Vanası**

U-PVC Solvent Cement True Union Ball Valve For Acid

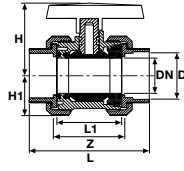

Düşük Dayanımlı Asit İçin  
For Low Strength Acid

Yüksek Dayanımlı Asit İçin  
For High Strength Acid

Çap Dia	Basınç PN	Kod / Code EPDM & PTFE O-Ring:	Fiyat (Adet) Price (Pcs)	Kod / Code EPDM & FPM O-Ring:	Fiyat (Adet) Price (Pcs)	Kg/Adet Kg/Pcs	Koli/Adet Box/Pcs	DN (mm)	Z (mm)	L1 (mm)	L (mm)	H (mm)	H1 (mm)	kv l/min
20	16	205 00 020 2	7,40 €	234 00 020 2	12,46 €	0,14	55	15	52	45	85	47	27	185
25	16	205 00 025 2	9,40 €	234 00 025 2	16,78 €	0,19	75	20	58	49	95	51	31	350
32	16	205 00 032 2	12,60 €	234 00 032 2	19,98 €	0,25	60	25	61	54	107	63	33	700
40	16	205 00 040 2	15,60 €	234 00 040 2	25,89 €	0,43	30	32	73	66	128	67	41	1000
50	16	205 00 050 2	18,20 €	234 00 050 2	32,29 €	0,66	24	40	82	75	154	86	46	1600
63	16	205 00 063 2	22,00 €	234 00 063 2	40,94 €	1,11	12	50	95	89	172	101	58	3100
75	16	205 00 075 2	52,00 €	234 00 075 2	92,45 €	1,48	10	65	118	111	196	110	73	5000
90	16	205 00 090 2	67,00 €	234 00 090 2	92,76 €	3,55	4	80	139	126	241	137	89	7000
110	16	205 00 110 2	86,00 €	234 00 110 2	130,50 €	5,48	2	100	165	153	289	150	105	11000

**U-PVC Küresel Asit Vanası (Tek Taraf İçten Dışlı)**

U-PVC One Side Female Threaded True Union Ball Valves For Acid

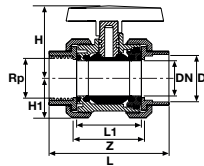

Düşük Dayanımlı Asit İçin  
For Low Strength Acid

Yüksek Dayanımlı Asit İçin  
For High Strength Acid

Çap Dia	Rp (Inch)	Basınç PN	Kod / Code EPDM & PTFE O-Ring:	Fiyat (Adet) Price (Pcs)	Kod / Code EPDM & FPM O-Ring:	Fiyat (Adet) Price (Pcs)	Kg/Adet Kg/Pcs	Koli/Adet Box/Pcs	DN (mm)	kv l/min	Z (mm)	L1 (mm)	L (mm)	H (mm)	H1 (mm)
20	1/2"	16	206 00 020 2	8,30 €	235 00 020 2	13,36 €	0,14	55	15	185	52	45	85	47	27
25	3/4"	16	206 00 025 2	10,40 €	235 00 025 2	17,78 €	0,19	75	20	350	58	49	95	51	31
32	1"	16	206 00 032 2	13,90 €	235 00 032 2	21,28 €	0,24	60	25	700	61	54	107	63	33
40	1 1/4"	16	206 00 040 2	16,90 €	235 00 040 2	27,19 €	0,42	30	32	1000	73	66	128	67	41
50	1 1/2"	16	206 00 050 2	19,50 €	235 00 050 2	33,59 €	0,66	24	40	1600	82	75	154	86	46
63	2"	16	206 00 063 2	23,30 €	235 00 063 2	42,24 €	1,19	12	50	3100	95	89	172	101	58
75	2 1/2"	16	206 00 075 2	54,00 €	235 00 075 2	94,45 €	1,51	10	65	5000	118	111	196	110	73
90	3"	16	206 00 090 2	69,00 €	235 00 090 2	94,76 €	3,57	4	80	7000	139	126	241	137	89
110	4"	16	206 00 110 2	89,00 €	235 00 110 2	133,50 €	5,36	2	100	11000	165	153	289	150	105

**U-PVC Küresel Asit Vanası (Çift Taraf İçten Dışlı)**

U-PVC Both Sides Female Threaded True Union Ball Valve For Acid

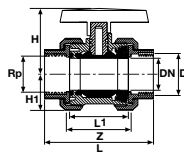

Düşük Dayanımlı Asit İçin  
For Low Strength Acid

Yüksek Dayanımlı Asit İçin  
For High Strength Acid

Rp (Inch)	Basınç PN	Kod / Code EPDM & PTFE O-Ring:	Fiyat (Adet) Price (Pcs)	Kod / Code EPDM & FMP O-Ring:	Fiyat (Adet) Price (Pcs)	Kg/Adet Kg/Pcs	Koli/Adet Box/Pcs	DN (mm)	Z (mm)	L1 (mm)	L (mm)	H (mm)	H1 (mm)	kv l/min
1/2"	16	207 00 020 2	9,20 €	236 00 020 2	14,26 €	0,14	55	15	52	45	85	47	27	185
3/4"	16	207 00 025 2	11,20 €	236 00 025 2	18,58 €	0,19	75	20	58	49	95	51	31	350
1"	16	207 00 032 2	14,20 €	236 00 032 2	21,58 €	0,24	60	25	61	54	107	63	33	700
1 1/4"	16	207 00 040 2	17,20 €	236 00 040 2	27,49 €	0,42	30	32	73	66	128	67	41	1000
1 1/2"	16	207 00 050 2	20,80 €	236 00 050 2	34,89 €	0,67	24	40	82	75	154	86	46	1600
2"	16	207 00 063 2	24,60 €	236 00 063 2	43,54 €	1,21	12	50	95	89	172	101	58	3100
2 1/2"	16	207 00 075 2	56,00 €	236 00 075 2	96,45 €	1,53	10	65	118	111	196	110	73	5000
3"	16	207 00 090 2	71,00 €	236 00 090 2	96,76 €	3,61	4	80	139	126	241	137	89	7000
4"	16	207 00 110 2	93,00 €	236 00 110 2	137,50 €	5,30	2	100	165	153	289	150	105	11000

### U-PVC Küresel Asit Vanası (Çift Taraf Flanş Bağlantılı)

U-PVC Both Sides Female Threaded Ball Valves For Acid

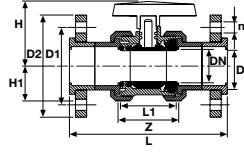

Düşük Dayanımlı Asit İçin  
For Low Strength Acid

Yüksek Dayanımlı Asit İçin  
For High Strength Acid

Çap Dia	Basınç PN	Kod / Code EPDM PTFE O-Ring	Fiyat (Adet) Price (Pcs)	Kod / Code EPDM FMP O-Ring	Fiyat (Adet) Price (Pcs)	Kg/Adet Kg/Pcs	Koli/Adet Box/Pcs	DN (mm)	Z (mm)	L1 (mm)	L (mm)	H (mm)	H1 (mm)	D1 (mm)	D2 (mm)	n (mmxAdet)
20	16	209 00 020 2	19,50 €	237 00 020 2	24,56 €	0,35	55	15	52	45	123	47	27	65	95	14 x 4
25	16	209 00 025 2	21,50 €	237 00 025 2	28,88 €	0,52	75	20	58	49	140	51	31	75	105	14 x 4
32	16	209 00 032 2	25,00 €	237 00 032 2	32,38 €	0,60	60	25	61	54	158	63	33	85	115	14 x 4
40	16	209 00 040 2	30,00 €	237 00 040 2	40,29 €	1,02	30	32	73	66	186	67	42	100	140	18 x 4
50	16	209 00 050 2	33,00 €	237 00 050 2	47,09 €	1,25	24	40	82	75	231	86	46	110	150	18 x 4
63	16	209 00 063 2	38,00 €	237 00 063 2	56,94 €	1,99	12	50	95	89	253	101	58	125	165	18 x 4
75	16	209 00 075 2	80,00 €	237 00 075 2	120,50 €	2,65	10	65	118	111	291	110	73	145	185	18 x 4
90	16	209 00 090 2	90,00 €	237 00 090 2	125,80 €	5,13	4	80	139	126	353	137	90	160	200	18 x 8
110	16	209 00 110 2	155,00 €	237 00 110 2	199,50 €	7,05	2	100	165	153	431	150	106	180	220	18 x 8

### U-PVC Üç Yollu Küresel Asit Vanası (T Port)

U-PVC Three Ways Ball Valve (T Port)

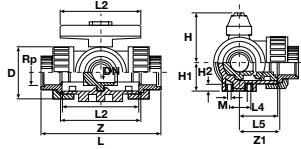

Çap Dia	Basınç PN	Kod Code	Fiyat (Adet) Price (Pcs)	Kg/Adet Kg/Pcs	Koli/Adet Box/Pcs	D (mm)	L (mm)	L1 (mm)	L2 (mm)	L3 (mm)	L4 (mm)	L5 (mm)	L6 (mm)	L7 (mm)	H (mm)
20	10	210 00 020 4	96,00 €	0,25	55	45	134	78	72	139	25	36	67	70	50
25	10	210 00 025 4	115,00 €	0,36	75	53	156	92	86	161	25	43	78	81	60
32	10	210 00 032 4	146,00 €	0,54	60	65	172	100	96	177	25	48	86	89	68
40	10	210 00 040 4	164,00 €	0,93	30	78	202	110	116	207	45	58	101	104	79
50	10	210 00 050 4	193,00 €	1,36	20	92	238	120	137	242	45	69	119	121	90
63	10	210 00 063 4	242,00 €	2,66	12	116	290	146	179	294	45	90	145	147	109

### U-PVC Üç Yollu İçten Dişli Küresel Asit Vanası (T Port)

U-PVC Three Ways Female Threaded Ball Valve (T Port)

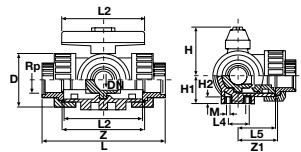

Çap Dia	Basınç PN	Kod Code	Fiyat (Adet) Price (Pcs)	Kg/Adet Kg/Pcs	Koli/Adet Box/Pcs	D (mm)	L (mm)	L1 (mm)	L2 (mm)	L4 (mm)	L5 (mm)	H (mm)	H1 (mm)
20	10	211 00 020 4	103,00 €	0,25	55	45	111	78	72	25	36	50	27
25	10	211 00 025 4	126,00 €	0,36	75	53	131	92	86	25	43	60	33
32	10	211 00 032 4	157,00 €	0,54	60	65	148	100	96	25	48	68	36
40	10	211 00 040 4	175,00 €	0,93	30	78	176	110	116	45	58	79	44
50	10	211 00 050 4	204,00 €	1,4	20	92	206	120	137	45	69	90	49
63	10	211 00 063 4	260,00 €	2,66	12	116	262	146	179	45	90	109	61

**U-PVC Küresel Asit Vanası (Pozisyon Ayarlı)**  
*U-PVC True Union Ball Valve Position Regulated For Acid*

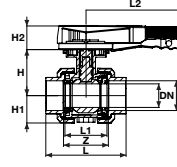

Düşük Dayanımlı Asit İçin  
*For Low Strength Acid*

Yüksek Dayanımlı Asit İçin  
*For High Strength Acid*

Çap Dia	Basınç PN	Kod / Code EPDM PTFE O-Ring	Fiyat (Adet) Price (Pcs)	Kod / Code EPDM PTFE O-Ring	Fiyat (Adet) Price (Pcs)	Kg/Adet Kg/Pcs	Koli/Adet Box/Pcs	DN (mm)	Z (mm)	L1 (mm)	L2 (mm)	L (mm)	H (mm)	H1 (mm)	H2 (mm)	kv l/min
63	16	205 10 063 2	27,40 €	234 10 063 2	41,10 €	1,16	12	50	98	87	207,5	172	101	58	48	3100
75	16	205 10 075 2	66,00 €	234 10 075 2	99,00 €	1,46	9	65	119	98	207,5	196	110	73	50	5000
90	16	205 10 090 2	85,50 €	234 10 090 2	128,25 €	3,51	4	80	156	126	207,5	241	137	89	52	7000
110	16	205 10 110 2	108,00 €	234 10 110 2	162,00 €	3,40	2	100	185	150	259,5	289	150	105	52	11000

**U-PVC Küresel Asit Vanası Tek Taraf İç Dişli (Pozisyon Ayarlı)**  
*U-PVC One Side Female Threaded True Union Ball Valve Position Regulated For Acid*

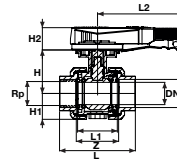

Düşük Dayanımlı Asit İçin  
*For Low Strength Acid*

Yüksek Dayanımlı Asit İçin  
*For High Strength Acid*

Çap Dia (Inch)	Rp	Basınç PN	Kod / Code EPDM PTFE O-Ring	Fiyat (Adet) Price (Pcs)	Kod / Code EPDM FMP O-Ring	Fiyat (Adet) Price (Pcs)	Kg/Adet Kg/Pcs	Koli/Adet Box/Pcs	DN (mm)	kv l/min	Z (mm)	L1 (mm)	L2 (mm)	L (mm)	H (mm)	H1 (mm)	H2 (mm)
63	2"	16	206 10 063 2	29,35 €	235 10 063 2	44,03 €	1,16	12	50	3100	98	87	207,5	172	101	58	48
75	2 1/2"	16	206 10 075 2	69,00 €	235 10 075 2	103,50 €	1,46	9	65	5000	119	98	207,5	196	110	73	50
90	3"	16	206 10 090 2	88,50 €	235 10 090 2	132,75 €	3,54	4	80	7000	156	126	207,5	241	137	89	52
110	4"	16	206 10 110 2	118,00 €	235 10 110 2	177,00 €	5,29	2	100	11000	185	150	259,5	289	150	105	52

**U-PVC Küresel Asit Vanası Çift Taraf İç Dişli (Pozisyon Ayarlı)**  
*U-PVC Both Sides Female Threaded True Union Ball Valve Position Regulated For Acid*

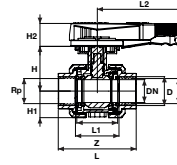

Düşük Dayanımlı Asit İçin  
*For Low Strength Acid*

Yüksek Dayanımlı Asit İçin  
*For High Strength Acid*

Rp (Inch)	Basınç PN	Kod / Code EPDM PTFE O-Ring	Fiyat (Adet) Price (Pcs)	Kod / Code EPDM FMP O-Ring	Fiyat (Adet) Price (Pcs)	Kg/Adet Kg/Pcs	Koli/Adet Box/Pcs	DN (mm)	Z (mm)	L1 (mm)	L2 (mm)	L (mm)	H (mm)	H1 (mm)	H2 (mm)	kv l/min
2"	16	207 10 063 2	31,30 €	236 10 063 2	46,95 €	1,19	12	50	98	87	207,5	172	101	58	48	3100
2 1/2"	16	207 10 075 2	72,00 €	236 10 075 2	108,00 €	1,19	9	65	119	98	207,5	196	110	73	50	5000
3"	16	207 10 090 2	91,50 €	236 10 090 2	137,25 €	1,19	4	80	156	126	207,5	241	137	89	52	7000
4"	16	207 10 110 2	123,50 €	236 10 110 2	185,25 €	1,19	2	100	185	150	259,5	289	150	105	52	11000

**U-PVC Küresel Asit Vanası Çift Taraf Flanş Bağlantılı (Pozisyon Ayarlı)**  
*U-PVC Both Sides Female Flanged True Union Ball Valve Position Regulated For Acid*

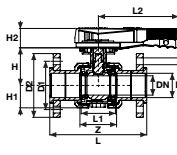

Düşük Dayanımlı Asit İçin  
*For Low Strength Acid*

Yüksek Dayanımlı Asit İçin  
*For High Strength Acid*

Çap Dia	Basınç PN	Kod / Code EPDM PTFE O-Ring	Fiyat (Adet) Price (Pcs)	Kod / Code EPDM FMP O-Ring	Fiyat (Adet) Price (Pcs)	Koli/Adet Box/Pcs	DN (mm)	Z (mm)	L1 (mm)	L2 (mm)	L (mm)	H (mm)	H1 (mm)	H2 (mm)	D1 (mm)	D2 (mm)	n (mmxAdet)
63	16	209 10 063 2	51,25 €	237 10 063 2	76,88 €	12	50	98	87	207,5	172	101	58	48	125	165	18 x 4
75	16	209 10 075 2	106,00 €	237 10 075 2	159,00 €	9	65	119	98	207,5	196	110	73	50	145	185	18 x 4
90	16	209 10 090 2	121,25 €	237 10 090 2	181,88 €	4	80	156	126	207,5	241	137	90	52	160	200	18 x 8
110	16	209 10 110 2	198,00 €	237 10 110 2	297,00 €	2	100	185	150	259,5	289	150	106	52	180	220	18 x 8



## U-PVC AKTÜATÖRLÜ KÜRESEL VANA AKTUATOR BALL VALVE

ÜRETİM STANDARDI / PRODUCTION STANDARD

TS EN ISO 16135  
ÇAP / SIZE Ø20 - Ø400



**U-PVC Aktüatör Uyumlu Küresel Vana**  
U-PVC Actuation Adaptor True Union Ball Valves

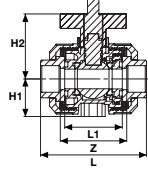

Çap Dia	Basınç PN	DN (mm)	kv l/min	Z mm	L1 (mm)	L (mm)	H1 (mm)	H2 (mm)	ISO 5211 Flanş ISO 5211 Interface	Kg/Adet Kg/Pcs	Koli/Adet Box/Pcs
20	16	15	185	52	45	85	27	79	F 03	0,156	1
25	16	20	350	58	49	95	31	87	F 03	0,206	1
32	16	25	700	61	54	107	33	91	F 05	0,267	1
40	16	32	1000	73	66	128	41	107	F 05	0,442	1
50	16	40	1600	82	75	154	46	127	F 05	0,69	1
63	16	50	3100	95	89	172	58	164	F 07	1,145	1
75	16	65	5000	118	111	196	65	178	F 07	1,51	1
90	16	80	7000	139	126	241	89	226	F 07	3,58	1
110	16	100	11000	165	153	289	105	258	F 07	5,48	1

**Su İçin**  
*For Water*

**Düşük Dayanımlı Asit İçin**  
*For Low Strength Acid*

**Yüksek Dayanımlı Asit İçin**  
*For High Strength Acid*

Çap Dia	EPDM Conta Kod EPDM O-Ring Code	Fiyat (Adet) Price (Pcs)
20	300 01 020 2	6,76 €
25	300 01 025 2	7,15 €
32	300 01 032 2	8,45 €
40	300 01 040 2	9,10 €
50	300 01 050 2	10,66 €
63	300 01 063 2	14,04 €
75	300 01 075 2	36,40 €
90	300 01 090 2	48,10 €
110	300 01 110 2	71,50 €

EPDM & PTFE Conta Kod EPDM & PTFE O-Ring Code	Fiyat (Adet) Price (Pcs)
300 02 020 2	9,62 €
300 02 025 2	12,22 €
300 02 032 2	16,38 €
300 02 040 2	20,28 €
300 02 050 2	23,66 €
300 02 063 2	28,60 €
300 02 075 2	67,60 €
300 02 090 2	87,10 €
300 02 110 2	111,80 €

FPM & PTFE Conta Kod FPM & PTFE O-Ring Code	Fiyat (€/Adet) Price (€/Pcs)
301 02 020 2	14,43 €
301 02 025 2	18,33 €
301 02 032 2	24,57 €
301 02 040 2	30,42 €
301 02 050 2	35,49 €
301 02 063 2	42,90 €
301 02 075 2	101,25 €
301 02 090 2	130,65 €
301 02 110 2	167,70 €



**U-PVC Aktüatör Uyumlu Küresel Vana (Tek Taraf İçten Dişli)**  
U-PVC Actuation Adaptor True Union Ball Valves (One Side Female Threaded)

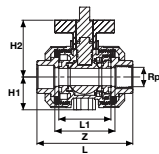

Çap Dia	Rp (Inch)	Basınç PN	DN (mm)	kv l/min	Z mm	L1 (mm)	L (mm)	H1 (mm)	H2 (mm)	ISO 5211 Flanş ISO 5211 Interface	Kg/Adet Kg/Pcs	Koli/Adet Box/Pcs
20	1/2"	16	15	185	52	45	85	27	79	F 03	0,15	1
25	3/4"	16	20	350	58	49	95	31	87	F 03	0,20	1
32	1"	16	25	700	61	54	107	33	91	F 05	0,26	1
40	1 1/4"	16	32	1000	73	66	128	41	107	F 05	0,44	1
50	1 1/2"	16	40	1600	82	75	154	46	127	F 05	0,69	1
63	2"	16	50	3100	95	89	172	58	164	F 07	1,14	1
75	2 1/2"	16	65	5000	118	111	196	65	178	F 07	1,51	1
90	3"	16	80	7000	139	126	241	89	226	F 07	3,58	1
110	4"	16	100	11000	165	153	289	105	258	F 07	5,48	1

**Su İçin**  
*For Water*

**Düşük Dayanımlı Asit İçin**  
*For Low Strength Acid*

**Yüksek Dayanımlı Asit İçin**  
*For High Strength Acid*

Çap Dia	Rp (Inch)	EPDM Conta Kod EPDM O-Ring Code	Fiyat (Adet) Price (Pcs)
20	1/2"	300 03 020 2	7,93 €
25	3/4"	300 03 025 2	8,45 €
32	1"	300 03 032 2	10,14 €
40	1 1/4"	300 03 040 2	10,79 €
50	1 1/2"	300 03 050 2	12,35 €
63	2"	300 03 063 2	15,73 €
75	2 1/2"	300 03 075 2	39,00 €
90	3"	300 03 090 2	50,70 €
110	4"	300 03 110 2	75,40 €

EPDM & PTFE Conta Kod EPDM & PTFE O-Ring Code	Fiyat (Adet) Price (Pcs)
300 04 020 2	10,76 €
300 04 025 2	13,52 €
300 04 032 2	18,07 €
300 04 040 2	21,97 €
300 04 050 2	25,35 €
300 04 063 2	30,29 €
300 04 075 2	70,20 €
300 04 090 2	89,70 €
300 04 110 2	115,70 €

FPM & PTFE Conta Kod FPM & PTFE O-Ring Code	Fiyat (Adet) Price (Pcs)
301 04 020 2	16,14 €
301 04 025 2	20,28 €
301 04 032 2	27,11 €
301 04 040 2	32,96 €
301 04 050 2	38,03 €
301 04 063 2	45,42 €
301 04 075 2	105,30 €
301 04 090 2	134,55 €
301 04 110 2	173,55 €

## U-PVC Aktüatör Uyumlu Küresel Vana (Çift Taraf İçten Dişli)

### U-PVC Actuation Adaptor True Union Ball Valves (Two Side Female Threaded)

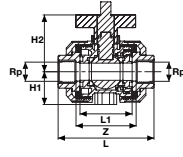

Çap Dia	Rp (Inch)	Basınç PN	DN (mm)	kv l/min	Z (mm)	L1 (mm)	L (mm)	H1 (mm)	H2 (mm)	ISO 5211 Flanş ISO 5211 Interface	Kg/Adet Kg/Pcs	Koli/Adet Box/Pcs
20	1/2"	16	15	185	52	45	85	27	79	F 03	0,15	1
25	3/4"	16	20	350	58	49	95	31	87	F 03	0,20	1
32	1"	16	25	700	61	54	107	33	91	F 05	0,26	1
40	1 1/4"	16	32	1000	73	66	128	41	107	F 05	0,44	1
50	1 1/2"	16	40	1600	82	75	154	46	127	F 05	0,69	1
63	2"	16	50	3100	95	89	172	58	164	F 07	1,14	1
75	2 1/2"	16	65	5000	118	111	196	65	178	F 07	1,51	1
90	3"	16	80	7000	139	126	241	89	226	F 07	3,58	1
110	4"	16	100	11000	165	153	289	105	258	F 07	5,48	1

#### Su İçin For Water

Rp (Inch)	EPDM Conta Kod EPDM O-Ring Code	Fiyat (Adet) Price (Pcs)
1/2"	300 05 020 2	9,10 €
3/4"	300 05 025 2	9,62 €
1"	300 05 032 2	11,57 €
1 1/4"	300 05 040 2	12,22 €
1 1/2"	300 05 050 2	14,04 €
2"	300 05 063 2	17,42 €
2 1/2"	300 05 075 2	41,60 €
3"	300 05 090 2	53,30 €
4"	300 05 110 2	79,30 €

#### Düşük Dayanımlı Asit İçin For Low Strength Acid

EPDM & PTFE Conta Kod EPDM & PTFE O-Ring Code	Fiyat (Adet) Price (Pcs)
300 06 020 2	11,96 €
300 06 025 2	14,56 €
300 06 032 2	18,46 €
300 06 040 2	22,36 €
300 06 050 2	27,04 €
300 06 063 2	31,98 €
300 06 075 2	72,80 €
300 06 090 2	92,30 €
300 06 110 2	120,90 €

#### Yüksek Dayanımlı Asit İçin For High Strength Acid

FPM & PTFE Conta Kod FPM & PTFE O-Ring Code	Fiyat (Adet) Price (Pcs)
301 06 020 2	17,94 €
301 06 025 2	21,84 €
301 06 032 2	27,69 €
301 06 040 2	33,54 €
301 06 050 2	40,56 €
301 06 063 2	47,94 €
301 06 075 2	109,20 €
301 06 090 2	138,45 €
301 06 110 2	181,35 €

## U-PVC Aktüatör Uyumlu Küresel Vana (Çift Taraf Flanş Bağlantılı)

### U-PVC Actuation Adaptor True Union Ball Valves (Both Side Flanged Ball Valve)

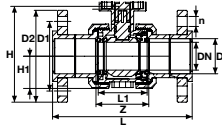

Çap Dia	Basınç PN	DN (mm)	kv l/min	Z (mm)	L1 (mm)	L (mm)	H (mm)	H1 (mm)	D1 (mm)	D2 (mm)	n (mm)	ISO 5211 Flanş ISO 5211 Interface	Kg/Adet Kg/Pcs	Koli/Adet Box/Pcs
20	16	15	185	52	45	123	131	27	65	96	14x4	F 03	0,37	1
25	16	20	350	58	49	140	133	31	75	105	14x4	F 03	0,49	1
32	16	25	700	61	54	158	141	33	85	115	14x4	F 05	0,68	1
40	16	32	1000	73	66	186	157	41	100	140	14x4	F 05	1,10	1
50	16	40	1600	82	75	231	182	46	100	150	18x4	F 05	1,48	1
63	16	50	3100	95	89	253	218	58	125	165	18x4	F 07	2,34	1
75	16	65	5000	118	111	291	228	65	145	185	22x4	F 07	3,03	1
90	16	80	7000	139	126	353	252	89	160	200	22x8	F 07	5,54	1
110	16	100	11000	165	153	431	276	105	180	220	24x8	F 07	8,10	1

#### Su İçin For Water

Çap Dia	EPDM Conta Kod EPDM O-Ring Code	Fiyat (Adet) Price (Pcs)
20	300 07 020 2	21,19 €
25	300 07 025 2	22,62 €
32	300 07 032 2	23,86 €
40	300 07 040 2	25,35 €
50	300 07 050 2	31,20 €
63	300 07 063 2	34,45 €
75	300 07 075 2	67,60 €
90	300 07 090 2	81,25 €
110	300 07 110 2	136,11 €

#### Düşük Dayanımlı Asit İçin For Low Strength Acid

EPDM & PTFE Conta Kod EPDM & PTFE O-Ring Code	Fiyat (Adet) Price (Pcs)
300 08 020 2	25,35 €
300 08 025 2	27,95 €
300 08 032 2	32,50 €
300 08 040 2	39,00 €
300 08 050 2	42,90 €
300 08 063 2	49,40 €
300 08 075 2	104,00 €
300 08 090 2	117,00 €
300 08 110 2	201,50 €

#### Yüksek Dayanımlı Asit İçin For High Strength Acid

FPM & PTFE Conta Kod FPM & PTFE O-Ring Code	Fiyat (Adet) Price (Pcs)
301 08 020 2	38,03 €
301 08 025 2	41,93 €
301 08 032 2	48,75 €
301 08 040 2	58,50 €
301 08 050 2	64,35 €
301 08 063 2	74,10 €
301 08 075 2	156,00 €
301 08 090 2	175,50 €
301 08 110 2	302,25 €

**U-PVC Elektrik Aktüatörlü Yapıştırma Mufllu Küresel Vana 24 V DC/24 V AC**  
*U-PVC Electric Actuator Solvent Cement True Union Ball Valve 24 V DC/24 V AC*

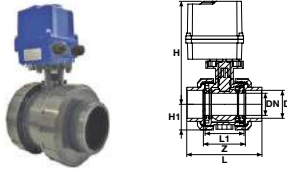

Çap Dia	Basınç PN	DN (mm)	kv l/min	Z (mm)	L1 (mm)	L (mm)	H1 (mm)	ISO 5211 Flanş ISO 5211 Interface	Kg/Adet Kg/Pcs	Koli/Adet Box/Pcs
20	16	15	185	52	45	85	27	F 03	1,44	1
25	16	20	350	58	49	95	31	F 03	1,49	1
32	16	25	700	61	54	107	33	F 05	1,54	1
40	16	32	1000	73	66	128	41	F 05	1,72	1
50	16	40	1600	82	75	154	46	F 05	1,95	1
63	16	50	3100	95	89	172	58	F 07	2,40	1
75	16	65	5000	118	111	196	65	F 07	3,96	1
90	16	80	7000	139	126	241	89	F 07	6,01	1
110	16	100	11000	165	153	289	105	F 07	7,91	1

**Su İçin**  
*For Water*

**Düşük Dayanımlı Asit İçin**  
*For Low Strength Acid*

**Yüksek Dayanımlı Asit İçin**  
*For High Strength Acid*

Çap Dia	EPDM Conta Kod EPDM O-Ring Code	Fiyat (Adet) Price (Pcs)	EPDM & PTFE Conta Kod EPDM & PTFE O-Ring Code	Fiyat (Adet) Price (Pcs)	FPM & PTFE Conta Kod FPM & PTFE O-Ring Code	Fiyat (Adet) Price (Pcs)
20	300 00 020 2	230,30 €	300 10 020 2	232,50 €	301 10 020 2	242,50 €
25	300 00 025 2	230,30 €	300 10 025 2	234,20 €	301 10 025 2	244,20 €
32	300 00 032 2	230,30 €	300 10 032 2	236,40 €	301 10 032 2	246,40 €
40	300 00 040 2	252,20 €	300 10 040 2	243,80 €	301 10 040 2	253,80 €
50	300 00 050 2	240,10 €	300 10 050 2	250,10 €	301 10 050 2	270,10 €
63	300 00 063 2	296,94 €	300 10 063 2	308,10 €	301 10 063 2	328,10 €
75	300 00 075 2	343,00 €	300 10 075 2	367,00 €	301 10 075 2	412,00 €
90	300 00 090 2	380,24 €	300 10 090 2	410,20 €	301 10 090 2	455,20 €
110	300 00 110 2	416,50 €	300 10 110 2	447,50 €	301 10 110 2	492,50 €

**U-PVC Elektrik Aktüatörlü Yapıştırma Mufllu Küresel Vana 110-260 V AC**  
*U-PVC Electric Actuator Solvent Cement True Union Ball Valve 110-260 V AC*

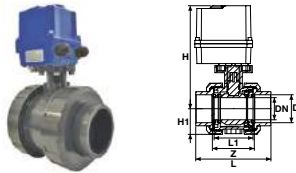

Çap Dia	Basınç PN	DN (mm)	kv l/min	Z (mm)	L1 (mm)	L (mm)	H (mm)	H1 (mm)	ISO 5211 Flanş ISO 5211 Interface	Kg/Adet Kg/Pcs	Koli/Adet Box/Pcs
20	16	15	185	52	45	85	209	27	F 03	1,44	1
25	16	20	350	58	49	95	215	31	F 03	1,49	1
32	16	25	700	61	54	107	225	33	F 05	1,54	1
40	16	32	1000	73	66	128	238	41	F 05	1,72	1
50	16	40	1600	82	75	154	253	46	F 05	1,95	1
63	16	50	3100	95	89	172	288	58	F 07	2,40	1
75	16	65	5000	118	111	196	305	65	F 07	3,96	1
90	16	80	7000	139	126	241	352	89	F 07	6,01	1
110	16	100	11000	165	153	289	385	105	F 07	7,91	1

**Su İçin**  
*For Water*

**Düşük Dayanımlı Asit İçin**  
*For Low Strength Acid*

**Yüksek Dayanımlı Asit İçin**  
*For High Strength Acid*

Çap Dia	EPDM Conta Kod EPDM O-Ring Code	Fiyat (Adet) Price (Pcs)	EPDM & PTFE Conta Kod EPDM & PTFE O-Ring Code	Fiyat (Adet) Price (Pcs)	FPM & PTFE Conta Kod FPM & PTFE O-Ring Code	Fiyat (Adet) Price (Pcs)
20	301 00 020 2	230,30 €	301 30 020 2	232,50 €	301 20 020 2	242,50 €
25	301 00 025 2	230,30 €	301 30 025 2	234,20 €	301 20 025 2	244,20 €
32	301 00 032 2	230,30 €	301 30 032 2	236,40 €	301 20 032 2	246,40 €
40	301 00 040 2	252,20 €	301 30 040 2	243,80 €	301 20 040 2	253,80 €
50	301 00 050 2	240,10 €	301 30 050 2	250,10 €	301 20 050 2	270,10 €
63	301 00 063 2	296,94 €	301 30 063 2	308,10 €	301 20 063 2	328,10 €
75	301 00 075 2	343,00 €	301 30 075 2	367,00 €	301 20 075 2	412,00 €
90	301 00 090 2	380,24 €	301 30 090 2	410,20 €	301 20 090 2	455,20 €
110	301 00 110 2	416,50 €	301 30 110 2	447,50 €	301 20 110 2	492,50 €



## U-PVC Elektrik Aktüatörlü Yapıştırma Muflu Küresel Vana Flanş Bağlantılı 24 V DC / 24 V AC

U-PVC True Ball Valve With Electric Actuator Two Side Flange Adaptor 24 V DC / 24 V AC

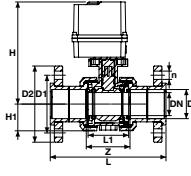

Çap Dia	Basınç PN	DN (mm)	kv l/min	Z (mm)	L1 (mm)	L (mm)	H (mm)	H1 (mm)	D1 (mm)	D2 (mm)	n (mm)	ISO 5211 Flanş ISO 5211 Interface	Kg/Adet Kg/Pcs	Koli/Adet Box/Pcs
20	16	15	185	60	48	123	209	27	65	96	14x4	F 03	1,66	1
25	16	20	350	58	45	140	215	31	75	105	14x4	F 03	1,77	1
32	16	25	700	68	49	158	225	33	85	115	14x4	F 05	1,96	1
40	16	32	1000	82	54	186	238	41	100	140	14x4	F 05	2,38	1
50	16	40	1600	94	65	231	253	46	100	150	18x4	F 05	2,74	1
63	16	50	3100	98	74	253	288	58	125	165	18x4	F 07	3,59	1
75	16	65	5000	119	87	291	305	65	145	185	22x4	F 07	5,49	1
90	16	80	7000	156	98	353	352	89	160	200	22x8	F 07	7,97	1
110	16	100	11000	185	150	431	385	105	180	220	24x8	F 07	10,5	1

### Su İçin For Water

Çap Dia	EPDM Conta Kod EPDM O-Ring Code	Fiyat (Adet) Price (Pcs)
20	306 00 020 2	241,40 €
25	306 00 025 2	242,20 €
32	306 00 032 2	242,20 €
40	306 00 040 2	247,70 €
50	306 00 050 2	255,90 €
63	306 00 063 2	312,60 €
75	306 00 075 2	367,00 €
90	306 00 090 2	405,70 €
110	306 00 110 2	466,20 €

### Düşük Dayanımlı Asit İçin For Low Strength Acid

EPDM & PTFE Conta Kod EPDM & PTFE O-Ring Code	Fiyat (Adet) Price (Pcs)
306 10 020 2	244,60 €
306 10 025 2	246,30 €
306 10 032 2	248,80 €
306 10 040 2	258,20 €
306 10 050 2	264,90 €
306 10 063 2	324,10 €
306 10 075 2	395,00 €
306 10 090 2	433,20 €
306 10 110 2	516,50 €

### Yüksek Dayanımlı Asit İçin For High Strength Acid

FPM & PTFE Conta Kod FPM & PTFE O-Ring Code	Fiyat (Adet) Price (Pcs)
306 20 020 2	254,60 €
306 20 025 2	256,30 €
306 20 032 2	258,80 €
306 20 040 2	268,20 €
306 20 050 2	284,90 €
306 20 063 2	344,10 €
306 20 075 2	440,00 €
306 20 090 2	478,20 €
306 20 110 2	561,50 €

## U-PVC Elektrik Aktüatörlü Yapıştırma Muflu Çift Taraf Flanşlı Küresel Vana 110- 260 V AC

U-PVC Both Sides Flanged Electric Actuator Ball Valve 110-260 V AC

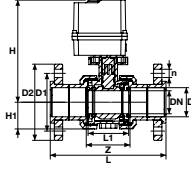

Çap Dia	Basınç PN	DN (mm)	kv l/min	Z (mm)	L1 (mm)	L (mm)	H (mm)	H1 (mm)	D1 (mm)	D2 (mm)	n (mm)	ISO 5211 Flanş ISO 5211 Interface	Kg/Adet Kg/Pcs	Koli/Adet Box/Pcs
20	16	15	185	52	45	123	209	27	65	96	14x4	F 03	1,66	1
25	16	20	350	58	49	140	215	31	75	105	14x4	F 03	1,77	1
32	16	25	700	61	54	158	225	33	85	115	14x4	F 05	1,96	1
40	16	32	1000	73	66	186	238	41	100	140	14x4	F 05	2,38	1
50	16	40	1600	82	75	231	253	46	100	150	18x4	F 05	2,74	1
63	16	50	3100	95	89	253	288	58	125	165	18x4	F 07	3,59	1
75	16	65	5000	118	111	291	305	65	145	185	22x4	F 07	5,49	1
90	16	80	7000	139	126	353	352	89	160	200	22x8	F 07	7,97	1
110	16	100	11000	165	153	431	385	105	180	220	24x8	F 07	10,5	1

### Su İçin For Water

Çap Dia	EPDM Conta Kod EPDM O-Ring Code	Fiyat (Adet) Price (Pcs)
20	307 00 020 2	241,40 €
25	307 00 025 2	242,20 €
32	307 00 032 2	242,20 €
40	307 00 040 2	247,70 €
50	307 00 050 2	255,90 €
63	307 00 063 2	312,60 €
75	307 00 075 2	367,00 €
90	307 00 090 2	405,70 €
110	307 00 110 2	466,20 €

### Düşük Dayanımlı Asit İçin For Low Strength Acid

EPDM & PTFE Conta Kod EPDM & PTFE O-Ring Code	Fiyat (Adet) Price (Pcs)
307 10 020 2	244,60 €
307 10 025 2	246,30 €
307 10 032 2	248,80 €
307 10 040 2	258,20 €
307 10 050 2	264,90 €
307 10 063 2	324,10 €
307 10 075 2	395,00 €
307 10 090 2	433,20 €
307 10 110 2	516,50 €

### Yüksek Dayanımlı Asit İçin For High Strength Acid

FPM & PTFE Conta Kod FPM & PTFE O-Ring Code	Fiyat (Adet) Price (Pcs)
307 20 020 2	254,60 €
307 20 025 2	256,30 €
307 20 032 2	258,80 €
307 20 040 2	268,20 €
307 20 050 2	284,90 €
307 20 063 2	344,10 €
307 20 075 2	440,00 €
307 20 090 2	478,20 €
307 20 110 2	561,50 €

**U-PVC Elektrik Aktüatörlü Yapıştırma Mufllu Küresel Vana Tek Taraf İç Dişli 24 V DC**  
*U-PVC True Ball Valve With Electric Actuator One Side Female Threaded 24 V DC*

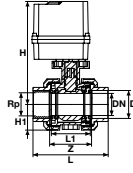

Çap Dia	Rp (Inch)	Basınç PN	DN (mm)	kv l/min	Z (mm)	L1 (mm)	L (mm)	H (mm)	H1 (mm)	ISO 5211 Flanş ISO 5211 Interface	Kg/Adet Kg/Pcs	Koli/Adet Box/Pcs
20	1/2"	16	15	185	52	45	85	209	27	F 03	1,44	1
25	3/4"	16	20	350	58	49	95	215	31	F 03	1,49	1
32	1"	16	25	700	61	54	107	225	33	F 05	1,54	1
40	1 1/4"	16	32	1000	73	66	128	238	41	F 05	1,72	1
50	1 1/2"	16	40	1600	82	75	154	253	46	F 05	1,95	1
63	2"	16	50	3100	95	89	172	288	58	F 07	2,40	1
75	2 1/2"	16	65	5000	118	111	196	305	65	F 07	3,96	1
90	3"	16	80	7000	139	126	241	352	89	F 07	6,01	1
110	4"	16	100	11000	165	153	289	385	105	F 07	7,91	1

**Su İçin**  
*For Water*

**Düşük Dayanımlı Asit İçin**  
*For Low Strength Acid*

**Yüksek Dayanımlı Asit İçin**  
*For High Strength Acid*

Çap Dia	Rp (Inch)	EPDM Conta Kod EPDM O-Ring Code	Fiyat (Adet) Price (Pcs)	EPDM & PTFE Conta Kod EPDM & PTFE O-Ring Code	Fiyat (Adet) Price (Pcs)	FPM & PTFE Conta Kod FPM & PTFE O-Ring Code	Fiyat (Adet) Price (Pcs)
20	1/2"	302 00 020 2	231,20 €	302 10 020 2	233,40 €	302 20 020 2	243,40 €
25	3/4"	302 00 025 2	231,30 €	302 10 025 2	235,20 €	302 20 025 2	245,20 €
32	1"	302 00 032 2	231,60 €	302 10 032 2	237,70 €	302 20 032 2	247,70 €
40	1 1/4"	302 00 040 2	236,50 €	302 10 040 2	245,10 €	302 20 040 2	255,10 €
50	1 1/2"	302 00 050 2	241,40 €	302 10 050 2	251,40 €	302 20 050 2	271,40 €
63	2"	302 00 063 2	298,20 €	302 10 063 2	309,40 €	302 20 063 2	329,40 €
75	2 1/2"	302 00 075 2	345,00 €	302 10 075 2	369,00 €	302 20 075 2	414,00 €
90	3"	302 00 090 2	382,20 €	302 10 090 2	412,20 €	302 20 090 2	457,20 €
110	4"	302 00 110 2	419,50 €	302 10 110 2	450,50 €	302 20 110 2	495,50 €

**U-PVC Elektrik Aktüatörlü Yapıştırma Mufllu Küresel Vana Tek Taraf İç Dişli 110-260 V AC**  
*U-PVC True Ball Valve With Electric Actuator One Side Female Threaded 110-260 V AC*

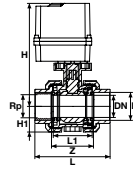

Çap Dia	Rp (Inch)	Basınç PN	DN (mm)	kv l/min	Z (mm)	L1 (mm)	L (mm)	H (mm)	H1 (mm)	ISO 5211 Flanş ISO 5211 Interface	Kg/Adet Kg/Pcs	Koli/Adet Box/Pcs
20	1/2"	16	15	185	52	45	85	209	27	F 03	1,44	1
25	3/4"	16	20	350	58	49	95	215	31	F 03	1,49	1
32	1"	16	25	700	61	54	107	225	33	F 05	1,54	1
40	1 1/4"	16	32	1000	73	66	128	238	41	F 05	1,72	1
50	1 1/2"	16	40	1600	82	75	154	253	46	F 05	1,95	1
63	2"	16	50	3100	95	89	172	288	58	F 07	2,40	1
75	2 1/2"	16	65	5000	118	111	196	305	65	F 07	3,96	1
90	3"	16	80	7000	139	126	241	352	89	F 07	6,01	1
110	4"	16	100	11000	165	153	289	385	105	F 07	7,91	1

**Su İçin**  
*For Water*

**Düşük Dayanımlı Asit İçin**  
*For Low Strength Acid*

**Yüksek Dayanımlı Asit İçin**  
*For High Strength Acid*

Çap Dia	Rp (Inch)	EPDM Conta Kod EPDM O-Ring Code	Fiyat (Adet) Price (Pcs)	EPDM & PTFE Conta Kod EPDM & PTFE O-Ring Code	Fiyat (Adet) Price (Pcs)	FPM & PTFE Conta Kod FPM & PTFE O-Ring Code	Fiyat (Adet) Price (Pcs)
20	1/2"	303 00 020 2	231,20 €	303 10 020 2	233,40 €	303 20 020 2	243,40 €
25	3/4"	303 00 025 2	231,30 €	303 10 025 2	235,20 €	303 20 025 2	245,20 €
32	1"	303 00 032 2	231,60 €	303 10 032 2	237,70 €	303 20 032 2	247,70 €
40	1 1/4"	303 00 040 2	236,50 €	303 10 040 2	245,10 €	303 20 040 2	255,10 €
50	1 1/2"	303 00 050 2	241,40 €	303 10 050 2	251,40 €	303 20 050 2	271,40 €
63	2"	303 00 063 2	298,20 €	303 10 063 2	309,40 €	303 20 063 2	329,40 €
75	2 1/2"	303 00 075 2	345,00 €	303 10 075 2	369,00 €	303 20 075 2	414,00 €
90	3"	303 00 090 2	404,84 €	303 10 090 2	412,20 €	303 20 090 2	457,20 €
110	4"	303 00 110 2	419,50 €	303 10 110 2	450,50 €	303 20 110 2	495,50 €

## U-PVC Elektrik Aktüatörlü Yapıştırma Muflu Küresel Vana Çift Taraf İç Dişli 24 V DC/24 V AC

### U-PVC True Ball Valve With Electric Actuator Two Side Female Threaded 24 V DC/24 V AC

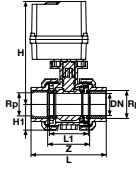

Rp (Inch)	Basınç PN	DN (mm)	kv l/min	Z (mm)	L1 (mm)	L (mm)	H (mm)	H1 (mm)	ISO 5211 Flanş ISO 5211 Interface	Kg/Adet Kg/Pcs	Koli/Adet Box/Pcs
1/2"	16	15	185	52	45	85	209	27	F 03	1,44	1
3/4"	16	20	350	58	49	95	215	31	F 03	1,49	1
1"	16	25	700	61	54	107	225	33	F 05	1,54	1
1 1/4"	16	32	1000	73	66	128	238	41	F 05	1,72	1
1 1/2"	16	40	1600	82	75	154	253	46	F 05	1,95	1
2"	16	50	3100	95	89	172	288	58	F 07	2,40	1
2 1/2"	16	65	5000	118	111	196	305	65	F 07	3,96	1
3"	16	80	7000	139	126	241	352	89	F 07	6,01	1
4"	16	100	11000	165	153	289	385	105	F 07	7,91	1

#### Su İçin For Water

Rp (Inch)	EPDM Conta Kod EPDM O-Ring Code	Fiyat (Adet) Price (Pcs)
1/2"	304 00 020 2	232,10 €
3/4"	304 00 025 2	232,20 €
1"	304 00 032 2	232,70 €
1 1/4"	304 00 040 2	237,60 €
1 1/2"	304 00 050 2	242,70 €
2"	304 00 063 2	299,50 €
2 1/2"	304 00 075 2	347,00 €
3"	304 00 090 2	384,20 €
4"	304 00 110 2	422,50 €

#### Düşük Dayanımlı Asit İçin For Low Strength Acid

EPDM & PTFE Conta Kod EPDM & PTFE O-Ring Code	Fiyat (Adet) Price (Pcs)
304 10 020 2	234,30 €
304 10 025 2	236,00 €
304 10 032 2	238,00 €
304 10 040 2	245,40 €
304 10 050 2	252,70 €
304 10 063 2	310,70 €
304 10 075 2	371,00 €
304 10 090 2	414,20 €
304 10 110 2	454,50 €

#### Yüksek Dayanımlı Asit İçin For High Strength Acid

FPM & PTFE Conta Kod FPM & PTFE O-Ring Code	Fiyat (Adet) Price (Pcs)
304 20 020 2	244,30 €
304 20 025 2	246,00 €
304 20 032 2	248,00 €
304 20 040 2	255,40 €
304 20 050 2	272,70 €
304 20 063 2	309,70 €
304 20 075 2	416,00 €
304 20 090 2	459,20 €
304 20 110 2	499,50 €



## U-PVC Elektrik Aktüatörlü Yapıştırma Muflu Küresel Vana Çift Taraf İç Dişli 110-260 V AC

### U-PVC True Ball Valve With Electric Actuator Two Side Female Threaded 110-260 V AC

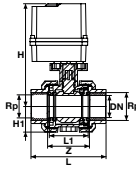

Rp (Inch)	Basınç PN	DN (mm)	kv l/min	Z (mm)	L1 (mm)	L (mm)	H (mm)	H1 (mm)	ISO 5211 Flanş ISO 5211 Interface	Kg/Adet Kg/Pcs	Koli/Adet Box/Pcs
1/2"	16	15	185	52	45	85	209	27	F 03	1,44	1
3/4"	16	20	350	58	49	95	215	31	F 03	1,49	1
1"	16	25	700	61	54	107	225	33	F 05	1,54	1
1 1/4"	16	32	1000	73	66	128	238	41	F 05	1,72	1
1 1/2"	16	40	1600	82	75	154	253	46	F 05	1,95	1
2"	16	50	3100	95	89	172	288	58	F 07	2,40	1
2 1/2"	16	65	5000	118	111	196	305	65	F 07	3,96	1
3"	16	80	7000	139	126	241	352	89	F 07	6,01	1
4"	16	100	11000	165	153	289	385	105	F 07	7,91	1

#### Su İçin For Water

Rp (Inch)	EPDM Conta Kod EPDM O-Ring Code	Fiyat (Adet) Price (Pcs)
1/2"	305 00 020 2	232,10 €
3/4"	305 00 025 2	232,20 €
1"	305 00 032 2	232,70 €
1 1/4"	305 00 040 2	237,60 €
1 1/2"	305 00 050 2	242,70 €
2"	305 00 063 2	299,50 €
2 1/2"	305 00 075 2	347,00 €
3"	305 00 090 2	384,20 €
4"	305 00 110 2	422,50 €

#### Düşük Dayanımlı Asit İçin For Low Strength Acid

EPDM & PTFE Conta Kod EPDM & PTFE O-Ring Code	Fiyat (Adet) Price (Pcs)
305 10 020 2	234,30 €
305 10 025 2	236,00 €
305 10 032 2	238,00 €
305 10 040 2	245,40 €
305 10 050 2	252,70 €
305 10 063 2	324,10 €
305 10 075 2	371,00 €
305 10 090 2	414,20 €
305 10 110 2	454,50 €

#### Yüksek Dayanımlı Asit İçin For High Strength Acid

FPM & PTFE Conta Kod FPM & PTFE O-Ring Code	Fiyat (Adet) Price (Pcs)
305 20 020 2	244,30 €
305 20 025 2	246,00 €
305 20 032 2	248,00 €
305 20 040 2	255,40 €
305 20 050 2	272,70 €
305 20 063 2	309,70 €
305 20 075 2	416,00 €
305 20 090 2	459,20 €
305 20 110 2	499,50 €

**U-PVC Pnömatik Aktüatörlü Tek Etkili Küresel Vana**  
U-PVC Pneumatic Actuator True Union Ball Valve

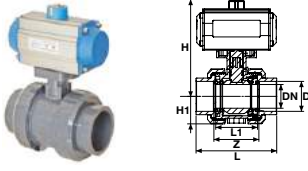

Çap Dia	Basınç PN	DN (mm)	kv l/min	Z (mm)	L1 (mm)	L (mm)	H (mm)	H1 (mm)	ISO 5211 Flanş ISO 5211 Interface	Kg/Adet Kg/Pcs	Koli/Adet Box/Pcs
20	16	15	185	52	45	85	131	27	F 03	0,61	1
25	16	20	350	58	49	95	133	31	F 03	0,66	1
32	16	25	700	61	54	107	141	33	F 05	0,71	1
40	16	32	1000	73	66	128	157	41	F 05	1,55	1
50	16	40	1600	82	75	154	182	46	F 05	1,78	1
63	16	50	3100	95	89	172	218	58	F 07	2,23	1
75	16	65	5000	118	111	196	228	65	F 07	3,43	1
90	16	80	7000	139	126	241	252	89	F 07	6,44	1
110	16	100	11000	165	153	289	276	105	F 07	9,19	1

Su İçin  
For Water

Düşük Dayanımlı Asit İçin  
For Low Strength Acid

Yüksek Dayanımlı Asit İçin  
For High Strength Acid

Çap Dia	EPDM Conta Kod EPDM O-Ring Code	Fiyat (Adet) Price (Pcs)	EPDM & PTFE Conta Kod EPDM & PTFE O-Ring Code	Fiyat (Adet) Price (Pcs)	FPM & PTFE Conta Kod FPM & PTFE O-Ring Code	Fiyat (Adet) Price (Pcs)
20	318 00 020 2	207,60 €	318 10 020 2	209,80 €	318 20 020 2	214,86 €
25	318 00 025 2	209,90 €	318 10 025 2	211,20 €	318 20 025 2	218,58 €
32	318 00 032 2	208,30 €	318 10 032 2	212,40 €	318 20 032 2	219,78 €
40	318 00 040 2	219,10 €	318 10 040 2	227,70 €	318 20 040 2	237,99 €
50	318 00 050 2	248,30 €	318 10 050 2	258,30 €	318 20 050 2	272,39 €
63	318 00 063 2	255,20 €	318 10 063 2	266,40 €	318 20 063 2	285,34 €
75	318 00 075 2	334,14 €	318 10 075 2	358,10 €	318 20 075 2	398,59 €
90	318 00 090 2	363,72 €	318 10 090 2	393,70 €	318 20 090 2	419,48 €
110	318 00 110 2	427,41 €	318 10 110 2	458,40 €	318 20 110 2	502,91 €

**U-PVC Pnömatik Aktüatörlü Çift Etkili Küresel Vana**  
U-PVC Pneumatic Actuator Double Acting True Union Ball Valve

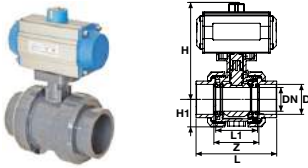

Çap Dia	Basınç PN	DN (mm)	kv l/min	Z (mm)	L1 (mm)	L (mm)	H (mm)	H1 (mm)	ISO 5211 Flanş ISO 5211 Interface	Kg/Adet Kg/Pcs	Koli/Adet Box/Pcs
20	16	15	185	52	45	85	131	27	F 03	0,61	1
25	16	20	350	58	49	95	133	31	F 03	0,66	1
32	16	25	700	61	54	107	141	33	F 05	0,71	1
40	16	32	1000	73	66	128	157	41	F 05	1,55	1
50	16	40	1600	82	75	154	182	46	F 05	1,78	1
63	16	50	3100	95	89	172	218	58	F 07	2,23	1
75	16	65	5000	118	111	196	228	65	F 07	3,43	1
90	16	80	7000	139	126	241	252	89	F 07	6,44	1
110	16	100	11000	165	153	289	276	105	F 07	9,19	1

Su İçin  
For Water

Düşük Dayanımlı Asit İçin  
For Low Strength Acid

Yüksek Dayanımlı Asit İçin  
For High Strength Acid

Çap Dia	EPDM Conta Kod EPDM O-Ring Code	Fiyat (Adet) Price (Pcs)	EPDM & PTFE Conta Kod EPDM & PTFE O-Ring Code	Fiyat (Adet) Price (Pcs)	FPM & PTFE Conta Kod FPM & PTFE O-Ring Code	Fiyat (Adet) Price (Pcs)
20	336 00 020 2	106,40 €	336 10 020 2	108,60 €	336 20 020 2	118,60 €
25	336 00 025 2	106,40 €	336 10 025 2	110,30 €	336 20 025 2	120,30 €
32	336 00 032 2	106,40 €	336 10 032 2	112,50 €	336 20 032 2	122,50 €
40	336 00 040 2	113,05 €	336 10 040 2	121,70 €	336 20 040 2	131,70 €
50	336 00 050 2	128,25 €	336 10 050 2	138,30 €	336 20 050 2	158,30 €
63	336 00 063 2	133,00 €	336 10 063 2	144,20 €	336 20 063 2	164,20 €
75	336 00 075 2	181,07 €	336 10 075 2	205,10 €	336 20 075 2	250,10 €
90	336 00 090 2	200,36 €	336 10 090 2	230,40 €	336 20 090 2	275,40 €
110	336 00 110 2	241,21 €	336 10 110 2	272,20 €	336 20 110 2	317,20 €

## U-PVC Tek Etkili Pnömatik Aktüatörlü Küresel Vana Çift Taraf Flanş Bağlantılı

U-PVC Pneumatic Actuator Double Acting True Union Ball Valves Both Side Flanged Ball Valve

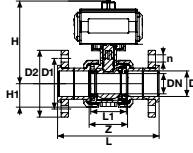

Çap Dia	Basınç PN	DN (mm)	kv l/min	Z (mm)	L1 (mm)	L (mm)	H (mm)	H1 (mm)	D1 (mm)	D2 (mm)	n (mm)	ISO 5211 Flanş ISO 5211 Interface	Kg/Adet Kg/Pcs	Koli/Adet Box/Pcs
20	16	15	185	52	45	123	131	27	65	96	14x4	F 03	0,83	1
25	16	20	350	58	49	140	133	31	75	105	14x4	F 03	0,94	1
32	16	25	700	61	54	158	141	33	85	115	14x4	F 05	1,13	1
40	16	32	1000	73	66	186	157	41	100	140	14x4	F 05	2,21	1
50	16	40	1600	82	75	231	182	46	100	150	18x4	F 05	2,57	1
63	16	50	3100	95	89	253	218	58	125	165	18x4	F 07	3,42	1
75	16	65	5000	118	111	291	228	65	145	185	22x4	F 07	4,96	1
90	16	80	7000	139	126	353	252	89	160	200	22x8	F 07	8,40	1
110	16	100	11000	165	153	431	276	105	180	220	24x8	F 07	11,8	1

Su İçin  
For Water

Düşük Dayanımlı Asit İçin  
For Low Strength Acid

Yüksek Dayanımlı Asit İçin  
For High Strength Acid

Çap Dia	EPDM Conta Kod EPDM O-Ring Code	Fiyat (Adet) Price (Pcs)	EPDM & PTFE Conta Kod EPDM & PTFE O-Ring Code	Fiyat (Adet) Price (Pcs)	FPM & PTFE Conta Kod FPM & PTFE O-Ring Code	Fiyat (Adet) Price (Pcs)
20	324 00 020 2	235,00 €	324 10 020 2	241,40 €	324 20 020 2	251,40 €
25	324 00 025 2	236,60 €	324 10 025 2	244,80 €	324 20 025 2	254,80 €
32	324 00 032 2	236,60 €	324 10 032 2	249,80 €	324 20 032 2	259,80 €
40	324 00 040 2	251,10 €	324 10 040 2	272,10 €	324 20 040 2	282,10 €
50	324 00 050 2	288,10 €	324 10 050 2	306,10 €	324 20 050 2	326,10 €
63	324 00 063 2	297,40 €	324 10 063 2	320,40 €	324 20 063 2	340,40 €
75	324 00 075 2	410,14 €	324 10 075 2	466,14 €	324 20 075 2	511,14 €
90	324 00 090 2	451,72 €	324 10 090 2	506,72 €	324 20 090 2	551,72 €
110	324 00 110 2	581,81 €	324 10 110 2	682,41 €	324 20 110 2	724,41 €

## U-PVC Çift Etkili Pnömatik Aktüatörlü Küresel Vana Çift Taraf Flanş Bağlantılı

U-PVC Pneumatic Actuator Double Acting True Union Ball Valves Both Side Flanged Ball Valve

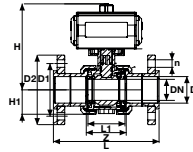

Çap Dia	Basınç PN	DN (mm)	kv l/min	Z (mm)	L1 (mm)	L (mm)	H (mm)	H1 (mm)	D1 (mm)	D2 (mm)	n (mm)	ISO 5211 Flanş ISO 5211 Interface	Kg/Adet Kg/Pcs	Koli/Adet Box/Pcs
20	16	15	185	52	45	123	131	27	65	96	14x4	F 03	0,83	1
25	16	20	350	58	49	140	133	31	75	105	14x4	F 03	0,94	1
32	16	25	700	61	54	158	141	33	85	115	14x4	F 05	1,13	1
40	16	32	1000	73	66	186	157	41	100	140	14x4	F 05	2,21	1
50	16	40	1600	82	75	231	182	46	100	150	18x4	F 05	2,57	1
63	16	50	3100	95	89	253	218	58	125	165	18x4	F 07	3,42	1
75	16	65	5000	118	111	291	228	65	145	185	22x4	F 07	4,96	1
90	16	80	7000	139	126	353	252	89	160	200	22x8	F 07	8,40	1
110	16	100	11000	165	153	431	276	105	180	220	24x8	F 07	11,8	1

Su İçin  
For Water

Düşük Dayanımlı Asit İçin  
For Low Strength Acid

Yüksek Dayanımlı Asit İçin  
For High Strength Acid

Çap Dia	EPDM Conta Kod EPDM O-Ring Code	Fiyat (Adet) Price (Pcs)	EPDM & PTFE Conta Kod EPDM & PTFE O-Ring Code	Fiyat (Adet) Price (Pcs)	FPM & PTFE Conta Kod FPM & PTFE O-Ring Code	Fiyat (Adet) Price (Pcs)
20	336 30 020 2	117,50 €	336 40 020 2	120,70 €	336 50 020 2	130,70 €
25	336 30 025 2	118,30 €	336 40 025 2	122,40 €	336 50 025 2	132,40 €
32	336 30 032 2	118,30 €	336 40 032 2	124,90 €	336 50 032 2	134,90 €
40	336 30 040 2	125,60 €	336 40 040 2	136,10 €	336 50 040 2	146,10 €
50	336 30 050 2	144,10 €	336 40 050 2	153,10 €	336 50 050 2	173,10 €
63	336 30 063 2	148,70 €	336 40 063 2	160,20 €	336 50 063 2	180,20 €
75	336 30 075 2	205,10 €	336 40 075 2	233,10 €	336 50 075 2	278,10 €
90	336 30 090 2	225,90 €	336 40 090 2	253,40 €	336 50 090 2	298,40 €
110	336 30 110 2	290,90 €	336 40 110 2	341,20 €	336 50 110 2	386,20 €

**U-PVC Pnömatik Aktüatörlü Tek Etkili Küresel Vana (Tek Taraf İçten Dişli)**

*U-PVC Pneumatic Actuator Double Acting True Union Ball Valves (One Side Female Threaded)*

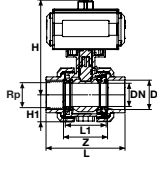

Çap Dia	Rp (Inch)	Basınç PN	DN (mm)	kv l/min	Z (mm)	L1 (mm)	L (mm)	H (mm)	H1 (mm)	ISO 5211 Flanş ISO 5211 Interface	Kg/Adet Kg/Pcs	Koli/Adet Box/Pcs
20	1/2"	16	15	185	52	45	85	131	27	F 03	0,61	1
25	3/4"	16	20	350	58	49	95	133	31	F 03	0,66	1
32	1"	16	25	700	61	54	107	141	33	F 05	0,71	1
40	1 1/4"	16	32	1000	73	66	128	157	41	F 05	1,55	1
50	1 1/2"	16	40	1600	82	75	154	182	46	F 05	1,78	1
63	2"	16	50	3100	95	89	172	218	58	F 07	2,23	1
75	2 1/2"	16	65	5000	118	111	196	228	65	F 07	3,43	1
90	3"	16	80	7000	139	126	241	252	89	F 07	6,44	1
110	4"	16	100	11000	165	153	289	276	105	F 07	9,19	1

Su İçin  
For Water

Düşük Dayanımlı Asit İçin  
For Low Strength Acid

Yüksek Dayanımlı Asit İçin  
For High Strength Acid

Çap Dia	Rp (Inch)	EPDM Conta Kod EPDM O-Ring Code	Fiyat (Adet) Price (Pcs)	EPDM & PTFE Conta Kod EPDM & PTFE O-Ring Code	Fiyat (Adet) Price (Pcs)	FPM & PTFE Conta Kod FPM & PTFE O-Ring Code	Fiyat (Adet) Price (Pcs)
20	1/2"	336 60 020 2	214,60 €	336 70 020 2	219,00 €	336 80 020 2	229,00 €
25	3/4"	336 60 025 2	214,80 €	336 70 025 2	222,60 €	336 80 025 2	232,60 €
32	1"	336 60 032 2	215,40 €	336 70 032 2	227,60 €	336 80 032 2	237,60 €
40	1 1/4"	336 60 040 2	228,70 €	336 70 040 2	245,90 €	336 80 040 2	255,90 €
50	1 1/2"	336 60 050 2	259,10 €	336 70 050 2	279,10 €	336 80 050 2	299,10 €
63	2"	336 60 063 2	268,60 €	336 70 063 2	291,00 €	336 80 063 2	311,00 €
75	2 1/2"	336 60 075 2	366,10 €	336 70 075 2	414,10 €	336 80 075 2	459,10 €
90	3"	336 60 090 2	404,70 €	336 70 090 2	464,70 €	336 80 090 2	509,70 €
110	4"	336 60 110 2	488,40 €	336 70 110 2	550,40 €	336 80 110 2	595,40 €

**U-PVC Pnömatik Aktüatörlü Çift Etkili Küresel Vana (Tek Taraf İçten Dişli)**

*U-PVC Pneumatic Actuator Double Acting True Union Ball Valves (One Side Female Threaded)*

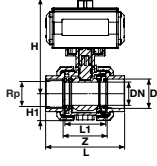

Çap Dia	Rp (Inch)	Basınç PN	DN (mm)	kv l/min	Z (mm)	L1 (mm)	L (mm)	H (mm)	H1 (mm)	ISO 5211 Flanş ISO 5211 Interface	Kg/Adet Kg/Pcs	Koli/Adet Box/Pcs
20	1/2"	16	15	185	52	45	85	131	27	F 03	0,61	1
25	3/4"	16	20	350	58	49	95	133	31	F 03	0,66	1
32	1"	16	25	700	61	54	107	141	33	F 05	0,71	1
40	1 1/4"	16	32	1000	73	66	128	157	41	F 05	1,55	1
50	1 1/2"	16	40	1600	82	75	154	182	46	F 05	1,78	1
63	2"	16	50	3100	95	89	172	218	58	F 07	2,23	1
75	2 1/2"	16	65	5000	118	111	196	228	65	F 07	3,43	1
90	3"	16	80	7000	139	126	241	252	89	F 07	6,44	1
110	4"	16	100	11000	165	153	289	276	105	F 07	9,19	1

Su İçin  
For Water

Düşük Dayanımlı Asit İçin  
For Low Strength Acid

Yüksek Dayanımlı Asit İçin  
For High Strength Acid

Çap Dia	Rp (Inch)	EPDM Conta Kod EPDM O-Ring Code	Fiyat (Adet) Price (Pcs)	EPDM & PTFE Conta Kod EPDM & PTFE O-Ring Code	Fiyat (Adet) Price (Pcs)	FPM & PTFE Conta Kod FPM & PTFE O-Ring Code	Fiyat (Adet) Price (Pcs)
20	1/2"	339 00 020 2	107,30 €	339 10 020 2	109,50 €	339 20 020 2	119,50 €
25	3/4"	339 00 025 2	107,40 €	339 10 025 2	111,30 €	339 20 025 2	121,30 €
32	1"	339 00 032 2	107,70 €	339 10 032 2	113,80 €	339 20 032 2	123,80 €
40	1 1/4"	339 00 040 2	114,40 €	339 10 040 2	123,00 €	339 20 040 2	133,00 €
50	1 1/2"	339 00 050 2	129,60 €	339 10 050 2	139,60 €	339 20 050 2	159,60 €
63	2"	339 00 063 2	134,30 €	339 10 063 2	145,50 €	339 20 063 2	165,50 €
75	2 1/2"	339 00 075 2	183,10 €	339 10 075 2	207,10 €	339 20 075 2	252,10 €
90	3"	339 00 090 2	202,40 €	339 10 090 2	232,40 €	339 20 090 2	277,40 €
110	4"	339 00 110 2	244,20 €	339 10 110 2	275,20 €	339 20 110 2	320,20 €

## U-PVC Pnömatik Aktüatörlü Tek Etkili Küresel Vana (Çift Taraf İçten Dişli)

U-PVC Pneumatic Actuator Double Acting True Union Ball Valves (Two Side Female Threaded)

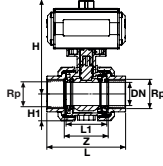

Rp (Inch)	Basınç PN	DN (mm)	kv l/min	Z (mm)	L1 (mm)	L (mm)	H (mm)	H1 (mm)	ISO 5211 Flanş ISO 5211 Interface	Kg/Adet Kg/Pcs	Koli/Adet Box/Pcs
1/2"	16	15	185	52	45	85	131	27	F 03	0,61	1
3/4"	16	20	350	58	49	95	133	31	F 03	0,66	1
1"	16	25	700	61	54	107	141	33	F 05	0,71	1
1 1/4"	16	32	1000	73	66	128	157	41	F 05	1,55	1
1 1/2"	16	40	1600	82	75	154	182	46	F 05	1,78	1
2"	16	50	3100	95	89	172	218	58	F 07	2,23	1
2 1/2"	16	65	5000	118	111	196	228	65	F 07	3,43	1
3"	16	80	7000	139	126	241	252	89	F 07	6,44	1
4"	16	100	11000	165	153	289	276	105	F 07	9,19	1

### Su İçin For Water

### Düşük Dayanımlı Asit İçin For Low Strength Acid

### Yüksek Dayanımlı Asit İçin For High Strength Acid

Rp (Inch)	EPDM Conta Kod EPDM O-Ring Code	Fiyat (Adet) Price (Pcs)	EPDM & PTFE Conta Kod EPDM & PTFE O-Ring Code	Fiyat (Adet) Price (Pcs)	FPM & PTFE Conta Kod FPM & PTFE O-Ring Code	Fiyat (Adet) Price (Pcs)
1/2"	337 30 020 2	216,40 €	337 40 020 2	220,80 €	337 50 020 2	230,80 €
3/4"	337 30 025 2	216,60 €	337 40 025 2	224,20 €	337 50 025 2	234,20 €
1"	337 30 032 2	217,60 €	337 40 032 2	228,20 €	337 50 032 2	238,20 €
1 1/4"	337 30 040 2	230,90 €	337 40 040 2	246,50 €	337 50 040 2	256,50 €
1 1/2"	337 30 050 2	261,70 €	337 40 050 2	281,70 €	337 50 050 2	301,70 €
2"	337 30 063 2	271,20 €	337 40 063 2	293,60 €	337 50 063 2	313,60 €
2 1/2"	337 30 075 2	370,10 €	337 40 075 2	418,10 €	337 50 075 2	463,10 €
3"	337 30 090 2	408,70 €	337 40 090 2	468,70 €	337 50 090 2	531,70 €
4"	337 30 110 2	494,40 €	337 40 110 2	558,40 €	337 50 110 2	603,40 €

## U-PVC Pnömatik Aktüatörlü Çift Etkili Küresel Vana (Çift Taraf İçten Dişli)

U-PVC Pneumatic Actuator Double Acting True Union Ball Valves (Two Side Female Threaded)

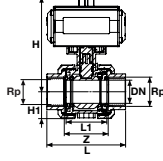

Rp (Inch)	Basınç PN	DN (mm)	kv l/min	Z (mm)	L1 (mm)	L (mm)	H (mm)	H1 (mm)	ISO 5211 Flanş ISO 5211 Interface	Kg/Adet Kg/Pcs	Koli/Adet Box/Pcs
1/2"	16	15	185	52	45	85	131	27	F 03	0,61	1
3/4"	16	20	350	58	49	95	133	31	F 03	0,66	1
1"	16	25	700	61	54	107	141	33	F 05	0,71	1
1 1/4"	16	32	1000	73	66	128	157	41	F 05	1,55	1
1 1/2"	16	40	1600	82	75	154	182	46	F 05	1,78	1
2"	16	50	3100	95	89	172	218	58	F 07	2,23	1
2 1/2"	16	65	5000	118	111	196	228	65	F 07	3,43	1
3"	16	80	7000	139	126	241	252	89	F 07	6,44	1
4"	16	100	11000	165	153	289	276	105	F 07	9,19	1

### Su İçin For Water

### Düşük Dayanımlı Asit İçin For Low Strength Acid

### Yüksek Dayanımlı Asit İçin For High Strength Acid

Rp (Inch)	EPDM Conta Kod EPDM O-Ring Code	Fiyat (Adet) Price (Pcs)	EPDM & PTFE Conta Kod EPDM & PTFE O-Ring Code	Fiyat (Adet) Price (Pcs)	FPM & PTFE Conta Kod FPM & PTFE O-Ring Code	Fiyat (Adet) Price (Pcs)
1/2"	337 60 020 2	108,20 €	337 70 020 2	110,40 €	337 80 020 2	120,40 €
3/4"	337 60 025 2	108,30 €	337 70 025 2	112,10 €	337 80 025 2	122,10 €
1"	337 60 032 2	108,80 €	337 70 032 2	114,10 €	337 80 032 2	124,10 €
1 1/4"	337 60 040 2	115,50 €	337 70 040 2	123,30 €	337 80 040 2	133,30 €
1 1/2"	337 60 050 2	130,90 €	337 70 050 2	140,90 €	337 80 050 2	160,90 €
2"	337 60 063 2	135,60 €	337 70 063 2	146,80 €	337 80 063 2	166,80 €
2 1/2"	337 60 075 2	185,10 €	337 70 075 2	209,10 €	337 80 075 2	254,10 €
3"	337 60 090 2	204,40 €	337 70 090 2	234,40 €	337 80 090 2	279,40 €
4"	337 60 110 2	247,20 €	337 70 110 2	279,20 €	337 80 110 2	324,20 €







**U-PVC**

**ÇEKVALF / CHECKVALVE**

**ÜRETİM STANDARDI / PRODUCTION STANDARD**

**EN 1452-3**

**ÇAP / SIZE Ø20 - Ø400**

**U-PVC Çıplak Çalparalı Çekvalf**  
U-PVC Wafer Check Valve

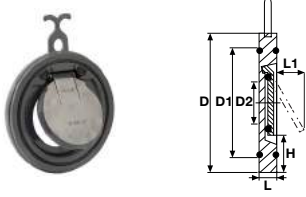

Su için / For Water

Asit için / For Acid

Çap Dia	Basınç PN	EPDM Conta Kod EPDM O-Ring Code	Fiyat (Adet) Price (Pcs)	FPM Conta Kod FPM O-Ring Code	Fiyat (Adet) Price (Pcs)	Kg /Adet Kg/Pcs	Koli/Ad. Box/Pcs	DN (mm)	D (mm)	D1 (mm)	D2 (mm)	L (mm)	L1 (mm)	H (mm)
63	10	221 01 063 9	20,75 €	221 02 063 9	28,20 €	0,19	30	50	90	75	32	16	40	18
75	10	221 01 075 9	25,75 €	221 02 075 9	34,70 €	0,26	30	65	110	95	40	16	55	20
90	10	221 01 090 9	28,75 €	221 02 090 9	38,60 €	0,34	10	80	125	115	54	16	67	23
110	10	221 01 110 9	33,85 €	221 02 110 9	45,30 €	0,48	10	100	184	135	70	19	67	35
125	10	221 01 125 9	38,80 €	221 02 125 9	51,70 €	0,55	10	100	213	160	92	21	94	37
140	10	221 01 140 9	44,40 €	221 02 140 9	60,30 €	0,64	15	125	213	160	92	21	94	37
160	10	221 01 160 9	50,00 €	221 02 160 9	68,20 €	0,95	15	150	251	175	105	23	100	47
200	10	221 01 200 9	62,00 €	221 02 200 9	85,15 €	1,32	10	200	280	235	155	27	152	41
225	10	221 01 225 9	71,00 €	221 02 225 9	92,30 €	1,57	10	200	280	235	155	27	152	41
250	10	221 01 250 9	135,00 €	221 02 250 9	195,00 €	2,57	5	250	330	285	330	40	180	41
280	10	221 01 280 9	203,00 €	221 02 280 9	248,00 €	2,58	1	250	330	285	330	40	180	41
315	10	221 01 315 9	275,00 €	221 02 315 9	377,00 €	3,87	1	300	380	325	380	45	215	41

**U-PVC Flanş Bağlantılı Çalparalı Çekvalf**  
U-PVC Wafer Check Valve With Flange

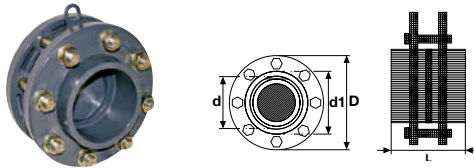

Su için / For Water

Asit için / For Acid

Çap Dia	Basınç PN	EPDM Conta Kod EPDM O-Ring Code	Fiyat (Adet) Price (Pcs)	FPM Conta Kod FPM O-Ring Code	Fiyat (Adet) Price (Pcs)	Kg /Adet Kg/Pcs	Koli/Ad. Box/Pcs	DN (mm)	D (mm)	D1 (mm)	L (mm)	nQe (mm)
63	10	221 00 063 2	38,00 €	221 08 063 2	49,40 €	1,83	4	50	165	77	90	4 x 16
75	10	221 00 075 2	42,00 €	221 08 075 2	54,60 €	2,31	4	65	185	90	110	4 x 16
90	10	221 00 090 2	48,00 €	221 08 090 2	62,40 €	3,75	4	80	200	107	126	8 x 16
110	10	221 00 110 2	58,00 €	221 08 110 2	75,40 €	4,35	4	100	220	129	155	8 x 16
125	10	221 00 125 2	63,00 €	221 08 125 2	81,90 €	5,35	2	100	250	147	173	8 x 16
140	10	221 00 140 2	73,00 €	221 08 140 2	95,00 €	5,87	2	125	250	164	182	8 x 16
160	10	221 00 160 2	83,00 €	221 08 160 2	108,00 €	7,03	1	150	285	188	209	8 x 20
200	10	221 00 200 2	124,00 €	221 08 200 2	161,00 €	10,0	1	200	340	230	253	8 x 20
225	10	221 00 225 2	144,00 €	221 08 225 2	187,00 €	10,5	1	200	340	245	285	8 x 20
250	10	221 00 250 2	304,00 €	221 08 250 2	395,00 €	16,2	1	250	395	269	375	12 x 20
280	10	221 00 280 2	378,00 €	221 08 280 2	491,00 €	15,5	1	250	395	304	375	12 x 20
315	10	221 00 315 2	531,00 €	221 08 315 2	690,00 €	19,8	1	300	445	341	415	12 x 20
400	10	221 00 400 2	1,200,00 €	221 08 400 2	1,560,00 €		1	400	565	450	482	16 x 24

### U-PVC Flanş Bağlanılı Çalparalı Çekvalf (Takım-304 Paslanmaz Civata-Somun-Pul) U-PVC Wafer Checkvalve With Flange (304 S.S. Screw, Nut, Washer)

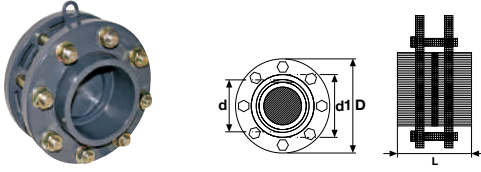

Su için / For Water

Asit için / For Acid

Çap Dia	Basınç PN	EPDM Conta Kod EPDM O-Ring Code	Fiyat (Adet) Price (Pcs)	FPM Conta Kod FPM O-Ring Code	Fiyat (Adet) Price (Pcs)	Kg /Adet Kg/Pcs	Koli/Ad. Box/Pcs	DN (mm)	D1 (mm)	D (mm)	L (mm)	nQe (mm)
63	10	221 04 063 2	53,20 €	221 05 063 2	63,84 €	3,10	4	50	77	165	90	4 x 16
75	10	221 04 075 2	58,80 €	221 05 075 2	70,56 €	3,40	4	65	90	185	110	4 x 16
90	10	221 04 090 2	67,20 €	221 05 090 2	80,64 €	3,71	4	80	107	200	126	8 x 16
110	10	221 04 110 2	81,20 €	221 05 110 2	97,44 €	4,56	4	100	129	220	155	8 x 16
125	10	221 04 125 2	88,20 €	221 05 125 2	105,84 €	5,55	2	100	147	250	173	8 x 16
140	10	221 04 140 2	102,20 €	221 05 140 2	122,64 €	5,77	2	125	164	250	182	8 x 16
160	10	221 04 160 2	116,20 €	221 05 160 2	139,44 €	7,47	1	150	188	285	209	8 x 20
200	10	221 04 200 2	173,60 €	221 05 200 2	208,32 €	10,0	1	200	230	340	253	8 x 20
225	10	221 04 225 2	201,60 €	221 05 225 2	241,92 €	10,1	1	200	245	340	285	8 x 20
250	10	221 04 250 2	425,60 €	221 05 250 2	510,72 €	20,6	1	250	269	395	375	12 x 20
280	10	221 04 280 2	529,20 €	221 05 280 2	635,04 €	20,5	1	250	304	395	375	12 x 20
315	10	221 04 315 2	742,40 €	221 05 315 2	892,08 €	25,1	1	300	341	445	415	12 x 20
400	10	221 04 400 2	1,680,00 €	221 05 400 2	2,016,00 €		1	400	450	565	482	16 x 24

### U-PVC Flanş Bağlanılı Çalparalı Çekvalf (Takım-316 Paslanmaz Civata-Somun-Pul) U-PVC Wafer Checkvalve With Flange (316 S.S. Screw, Nut, Washer)

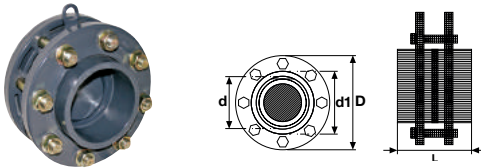

Su için / For Water

Asit için / For Acid

Çap Dia	Basınç PN	EPDM Conta Kod EPDM O-Ring Code	Fiyat (Adet) Price (Pcs)	FPM Conta Kod FPM O-Ring Code	Fiyat (Adet) Price (Pcs)	Kg /Adet Kg/Pcs	Koli/Ad. Box/Pcs	DN (mm)	D1 (mm)	D (mm)	L (mm)	nQe (mm)
63	10	221 06 063 2	74,48 €	221 07 063 2	89,38 €	3,10	4	50	77	165	90	4 x 16
75	10	221 06 075 2	82,32 €	221 07 075 2	98,78 €	3,40	4	65	90	185	110	4 x 16
90	10	221 06 090 2	94,08 €	221 07 090 2	112,90 €	3,71	4	80	107	200	126	8 x 16
110	10	221 06 110 2	113,68 €	221 07 110 2	136,42 €	4,56	4	100	129	220	155	8 x 16
125	10	221 06 125 2	123,48 €	221 07 125 2	148,18 €	5,55	2	100	147	250	173	8 x 16
140	10	221 06 140 2	143,08 €	221 07 140 2	171,70 €	5,77	2	125	164	250	182	8 x 16
160	10	221 06 160 2	162,68 €	221 07 160 2	195,22 €	7,47	1	150	188	285	209	8 x 20
200	10	221 06 200 2	243,04 €	221 07 200 2	291,65 €	10,0	1	200	230	340	253	8 x 20
225	10	221 06 225 2	282,24 €	221 07 225 2	338,69 €	10,1	1	200	245	340	285	8 x 20
250	10	221 06 250 2	595,84 €	221 07 250 2	715,00 €	20,6	1	250	269	395	375	12 x 20
280	10	221 06 280 2	740,88 €	221 07 280 2	889,06 €	20,5	1	250	304	395	375	12 x 20
315	10	221 06 315 2	1,040,76 €	221 07 315 2	1,248,91 €	25,1	1	300	341	445	415	12 x 20
400	10	221 06 400 2	2,352,00 €	221 07 400 2	2,822,40 €		1	400	450	565	482	16 x 24



**U-PVC Yapıştırma Muflu Yaylı Çekvalf**  
U-PVC Solvent Cement Spring Checkvalve

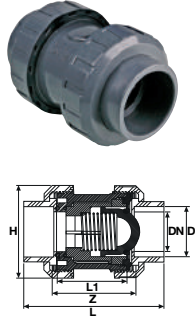

Çap Dia	Basınç PN	EPDM Conta Kod EPDM O-Ring Code	Fiyat (Adet) Price (Pcs)	Kg/Adet Kg/Pcs	Koli/Adet Box/Pcs	DN (mm)	H (mm)	L (mm)	L1 (mm)	Z (mm)
16	16	214 00 016 2	6,25 €	0,10	70	12	54	80	42	50
20	16	214 00 020 2	5,25 €	0,11	70	16	54	85	45	52
25	16	214 00 025 2	5,75 €	0,14	85	20	62	95	49	58
32	16	214 00 032 2	7,15 €	0,20	72	25	66	107	54	61
40	16	214 00 040 2	7,85 €	0,37	32	32	84	128	66	73
50	16	214 00 050 2	8,85 €	0,53	24	40	92	154	75	82
63	16	214 00 063 2	11,75 €	0,95	13	50	116	172	89	95
75	16	214 00 075 2	27,50 €	1,21	10	65	146	196	111	118
90	16	214 00 090 2	30,50 €	3,15	4	80	178	241	126	139
110	16	214 00 110 2	53,50 €	4,59	2	100	210	289	153	165

**U-PVC Tek Taraf İçten Dişli Yaylı Çekvalf**  
U-PVC One Side Female Threaded Spring Checkvalve

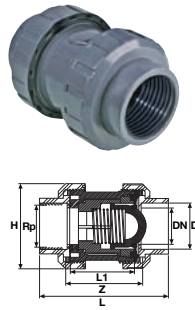

Çap Dia	Rp Inch	Basınç PN	EPDM Conta Kod EPDM O-Ring Code	Fiyat (Adet) Price (Pcs)	Kg/Adet Kg/Pcs	Koli/Adet Box/Pcs	DN (mm)	H (mm)	L (mm)	L1 (mm)	Z (mm)
16	3/8"	16	215 00 016 2	6,85 €	0,10	70	12	54	80	42	50
20	1/2"	16	215 00 020 2	5,85 €	0,11	70	16	54	85	45	52
25	3/4"	16	215 00 025 2	6,35 €	0,14	85	20	62	95	49	58
32	1"	16	215 00 032 2	7,85 €	0,20	72	25	66	107	54	61
40	1 1/4"	16	215 00 040 2	8,55 €	0,37	32	32	84	128	66	73
50	1 1/2"	16	215 00 050 2	9,75 €	0,53	24	40	92	154	75	82
63	2"	16	215 00 063 2	12,65 €	0,95	13	50	116	172	89	95
75	2 1/2"	16	215 00 075 2	29,05 €	1,21	10	65	146	196	111	118
90	3"	16	215 00 090 2	32,05 €	3,15	4	80	178	241	126	139
110	4"	16	215 00 110 2	55,00 €	4,59	2	100	210	289	153	165

**U-PVC Çift Taraf İçten Dişli Yaylı Çekvalf**  
U-PVC Both Sides Female Threaded Spring Checkvalve

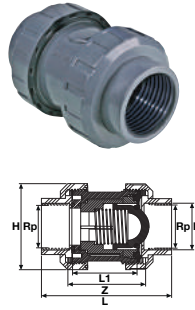

Rp Inch	Basınç PN	EPDM Conta Kod EPDM O-Ring Code	Fiyat (Adet) Price (Pcs)	Kg/Adet Kg/Pcs	Koli/Adet Box/Pcs	DN (mm)	H (mm)	L (mm)	L1 (mm)	Z (mm)
3/8"	16	216 00 016 2	7,45 €	0,10	70	12	54	80	42	50
1/2"	16	216 00 020 2	6,45 €	0,11	70	16	54	85	45	52
3/4"	16	216 00 025 2	6,95 €	0,14	85	20	62	95	49	58
1"	16	216 00 032 2	8,55 €	0,20	72	25	66	107	54	61
1 1/4"	16	216 00 040 2	9,25 €	0,37	32	32	84	128	66	73
1 1/2"	16	216 00 050 2	10,65 €	0,53	24	40	92	154	75	82
2"	16	216 00 063 2	13,55 €	0,95	13	50	116	172	89	95
2 1/2"	16	216 00 075 2	30,00 €	1,21	10	65	146	196	111	118
3"	16	216 00 090 2	33,00 €	3,15	4	80	178	241	126	139
4"	16	216 00 110 2	56,00 €	4,59	2	100	210	289	153	165

**U-PVC Flanş Bağlantılı Yaylı Çekvalf**  
U-PVC Both Sides Flanged Spring Checkvalve

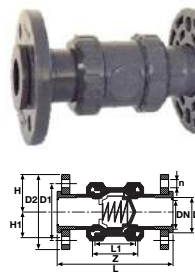

Çap Dia	Basınç PN	EPDM Conta Kod EPDM O-Ring Code	Fiyat (Adet) Price (Pcs)	Koli/Adet Box/Pcs	DN (mm)	Z (mm)	L1 (mm)	L (mm)	H (mm)	D1 (mm)	D2 (mm)	n (mm)
20	16	216 01 020 2	7,41 €	60	16	52	45	123	54	65	96	14x4
25	16	216 01 025 2	7,99 €	75	20	58	49	140	62	75	105	14x4
32	16	216 01 032 2	9,83 €	60	25	61	54	158	66	85	115	14x4
40	16	216 01 040 2	10,63 €	32	32	73	66	186	84	100	140	14x4
50	16	216 01 050 2	12,24 €	24	40	82	75	231	92	100	150	18x4
63	16	216 01 063 2	15,58 €	13	50	95	89	253	116	125	165	18x4
75	16	216 01 075 2	34,50 €	9	65	118	111	291	146	145	185	18x4
90	16	216 01 090 2	37,95 €	4	80	139	126	353	178	160	200	18x8
110	16	216 01 110 2	64,40 €	2	100	165	153	431	210	180	220	18x8

### U-PVC Yapıştırma Mufllu Toplu Çekvalf

#### U-PVC Solvent Cement Ball Checkvalve

NEW

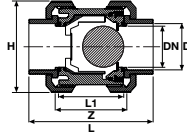

Çap Dia	Basınç PN	EPDM Conta Kod EPDM O-Ring Code	Fiyat (Adet) Price (Pcs)	Kg/Adet Kg/Pcs	Koli/Adet Box/Pcs	DN (mm)	H (mm)	L (mm)	L1 (mm)	Z (mm)
16	16	217 00 016 2	18,75 €	0,10	70	12	54	80	42	50
20	16	217 00 020 2	15,75 €	0,10	70	16	54	85	45	52
25	16	217 00 025 2	17,25 €	0,10	85	20	62	95	49	58
32	16	217 00 032 2	21,45 €	0,15	72	25	66	107	54	61
40	16	217 00 040 2	23,55 €	0,54	32	32	84	128	66	73
50	16	217 00 050 2	26,55 €	0,54	24	40	92	154	75	82
63	16	217 00 063 2	35,25 €	0,54	13	50	116	172	89	95

### U-PVC Tek Taraf İçten Dişli Toplu Çekvalf

#### U-PVC One Side Female Threaded Ball Checkvalve

NEW

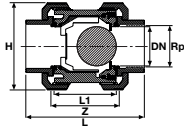

Çap Dia	Rp Inch	Basınç PN	EPDM Conta Kod EPDM O-Ring Code	Fiyat (Adet) Price (Pcs)	Kg/Adet Kg/Pcs	Koli/Adet Box/Pcs	DN (mm)	H (mm)	L (mm)	L1 (mm)	Z (mm)
16	3/8"	16	217 01 016 2	20,55 €	0,12	70	12	54	80	42	50
20	1/2"	16	217 01 020 2	17,55 €	0,10	70	16	54	85	45	52
25	3/4"	16	217 01 025 2	19,05 €	0,15	85	20	62	95	49	58
32	1"	16	217 01 032 2	23,55 €	0,19	72	25	66	107	54	61
40	1 1/4"	16	217 01 040 2	25,65 €	0,35	32	32	84	128	66	73
50	1 1/2"	16	217 01 050 2	29,25 €	0,54	24	40	92	154	75	82
63	2"	16	217 01 063 2	37,95 €	0,91	13	50	116	172	89	95



### U-PVC Çift Taraf İçten Dişli Toplu Çekvalf

#### U-PVC Both Sides Female Threaded Ball Checkvalve

NEW

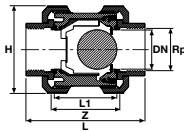

Rp Inch	Basınç PN	EPDM Conta Kod EPDM O-Ring Code	Fiyat (Adet) Price (Pcs)	Kg/Adet Kg/Pcs	Koli/Adet Box/Pcs	DN (mm)	H (mm)	L (mm)	L1 (mm)	Z (mm)
3/8"	16	217 02 016 2	22,35 €	0,12	70	12	54	80	42	50
1/2"	16	217 02 020 2	19,35 €	0,10	70	16	54	85	45	52
3/4"	16	217 02 025 2	20,85 €	0,15	85	20	62	95	49	58
1"	16	217 02 032 2	25,65 €	0,19	72	25	66	107	54	61
1 1/4"	16	217 02 040 2	27,75 €	0,35	32	32	84	128	66	73
1 1/2"	16	217 02 050 2	31,95 €	0,54	24	40	92	154	75	82
2"	16	217 02 063 2	40,65 €	0,91	13	50	116	172	89	95

### U-PVC Yapıştırma Mufllu Tek Taraflı Yaylı Çekvalf

U-PVC Single Union Spring Checkvalve

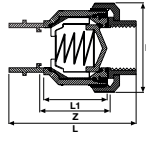

Çap Dia	Basınç PN	EPDM Conta Kod EPDM O-Ring Code	Fiyat (Adet) Price (Pcs)	Kg/Adet Kg/Pcs	Koli/Adet Box/Pcs	DN (mm)	H (mm)	L (mm)	L1 (mm)	Z (mm)
20	16	214 10 020 2	4,42 €	0,09	60	16	47	47	45	55
25	16	214 10 025 2	4,68 €	0,16	75	20	52	52	49	59
32	16	214 10 032 2	5,53 €	0,20	60	25	63	63	54	69
40	16	214 10 040 2	5,95 €	0,45	32	32	66	66	66	72
50	16	214 10 050 2	6,97 €	0,54	20	40	89	89	75	91
63	16	214 10 063 2	9,18 €	0,95	13	50	100	100	89	103
75	16	214 10 075 2	25,50 €		9	65	146	128	111	111
90	16	214 10 090 2	29,05 €		4	80	178	227	125	141
110	16	214 10 110 2	50,10 €		2	100	210	275	155	171

### U-PVC Tek Taraf İç Dişli Tek Taraflı Yaylı Çekvalf

U-PVC One Side Female Threaded Single Union Spring Checkvalve

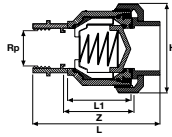

Çap Dia	Rp Inch	Basınç PN	EPDM Conta Kod EPDM O-Ring Code	Fiyat (Adet) Price (Pcs)	Kg/Adet Kg/Pcs	Koli/Adet Box/Pcs	DN (mm)	H (mm)	L (mm)	L1 (mm)	Z (mm)
20	1/2"	16	215 10 020 2	5,30 €	0,09	60	16	47	47	45	55
25	3/4"	16	215 10 025 2	5,65 €	0,16	75	20	52	52	49	59
32	1"	16	215 10 032 2	6,78 €	0,20	60	25	63	63	54	69
40	1 1/4"	16	215 10 040 2	7,22 €	0,45	32	32	66	66	66	72
50	1 1/2"	16	215 10 050 2	8,26 €	0,54	20	40	89	89	75	91
63	2"	16	215 10 063 2	10,52 €	0,95	13	50	100	100	89	103
75	2 1/2"	16	215 10 075 2	27,00 €		9	65	146	128	111	111
90	3"	16	215 10 090 2	31,50 €		4	80	178	227	125	141
110	4"	16	215 10 110 2	52,10 €		2	100	210	275	155	171

### U-PVC Çift Taraf İç Dişli Tek Taraflı Yaylı Çekvalf

U-PVC Both Sides Female Threaded Single Union Spring Checkvalve

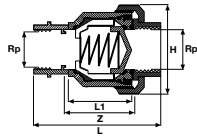

Rp Inch	Basınç PN	EPDM Conta Kod EPDM O-Ring Code	Fiyat (Adet) Price (Pcs)	Kg/Adet Kg/Pcs	Koli/Adet Box/Pcs	DN (mm)	H (mm)	L (mm)	L1 (mm)	Z (mm)
1/2"	16	216 10 020 2	6,09 €	0,09	60	16	47	78	45	55
3/4"	16	216 10 025 2	6,43 €	0,16	75	20	52	87	49	59
1"	16	216 10 032 2	7,74 €	0,20	60	25	63	100	54	69
1 1/4"	16	216 10 040 2	8,17 €	0,45	32	32	66	114	66	72
1 1/2"	16	216 10 050 2	9,39 €	0,54	20	40	89	140	75	91
2"	16	216 10 063 2	11,65 €	0,95	13	50	100	163	89	103
2 1/2"	16	216 10 075 2	27,00 €		9	65	146	196	111	111
3"	16	216 10 090 2	31,50 €		4	80	178	227	125	141
4"	16	216 10 110 2	52,10 €		2	100	210	275	155	171

### U-PVC Tek Taraf Dış Dişli Tek Taraflı Yaylı Çekvalf

U-PVC One Side Male Threaded Single Union Spring Checkvalve

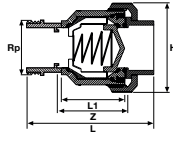

Çap Dia	Rp Inch	Basınç PN	EPDM Conta Kod EPDM O-Ring Code	Fiyat (Adet) Price (Pcs)	Kg/Adet Kg/Pcs	Koli/Adet Box/Pcs	DN (mm)	H (mm)	L (mm)	L1 (mm)	Z (mm)
20	1/2"	16	215 20 020 2	5,30 €	0,09	60	16	47	78	45	55
25	3/4"	16	215 20 025 2	5,65 €	0,16	75	20	52	87	49	59
32	1"	16	215 20 032 2	6,78 €	0,20	60	25	63	100	54	69
40	1 1/4"	16	215 20 040 2	7,22 €	0,45	32	32	66	114	66	72
50	1 1/2"	16	215 20 050 2	8,26 €	0,54	20	40	89	140	75	91
63	2"	16	215 20 063 2	10,52 €	0,95	13	50	100	163	89	103
75	2 1/2"	16	215 20 075 2	27,00 €		9	65	146	196	111	111
90	3"	16	215 20 090 2	31,50 €		4	80	178	227	125	141
110	4"	16	215 20 110 2	52,10 €		2	100	210	275	155	171

### U-PVC Tek Taraf Dış Dişli Tek Taraf İç Dişli Yaylı Çekvalf

U-PVC One Side Male Threaded One Side Female Threaded Single Union Spring Checkvalve

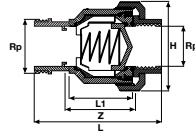

Çap Dia	Rp Inch	Basınç PN	EPDM Conta Kod EPDM O-Ring Code	Fiyat (Adet) Price (Pcs)	Kg/Adet Kg/Pcs	Koli/Adet Box/Pcs	DN (mm)	H (mm)	L (mm)	L1 (mm)	Z (mm)
20	1/2"	16	216 20 020 2	6,09 €	0,09	60	16	47	78	45	55
25	3/4"	16	216 20 025 2	6,43 €	0,16	75	20	52	87	49	59
32	1"	16	216 20 032 2	7,74 €	0,20	60	25	63	100	54	69
40	1 1/4"	16	216 20 040 2	8,17 €	0,45	32	32	66	114	66	72
50	1 1/2"	16	216 20 050 2	9,39 €	0,54	20	40	89	140	75	91
63	2"	16	216 20 063 2	11,65 €	0,95	13	50	100	163	89	103
75	2 1/2"	16	216 20 075 2	27,00 €		9	65	146	196	111	111
90	3"	16	216 20 090 2	31,50 €		4	80	178	227	125	141
110	4"	16	216 20 110 2	52,10 €		2	100	210	275	155	171

### U-PVC Y Çekvalf

U-PVC Angle Seat Valve

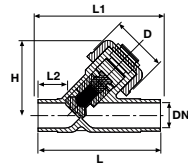

Çap Dia	Basınç PN	EPDM Conta Kod EPDM O-Ring Code	Fiyat (Adet) Price (Pcs)	Kg/Adet Kg/Pcs	Koli/Adet Box/Pcs	DN (mm)	D (mm)	L (mm)	L1 (mm)	L2 (mm)	H (mm)
20	16	222 00 020 4	51,00 €	0,13	1	15	43	124	130	28	65
25	16	222 00 025 4	60,00 €	0,20	1	20	47	144	150	37	75
32	16	222 00 032 4	72,00 €	0,32	1	25	56	154	160	37	90
40	16	222 00 040 4	89,00 €	0,49	1	32	64	174	180	44	102
50	16	222 00 050 4	129,00 €	0,86	1	40	82	194	200	48	123
63	16	222 00 063 4	187,00 €	1,45	1	50	95	224	230	60	144
75	16	222 00 075 4	321,00 €	2,49	1	65	92	284	290	74	186
90	16	222 00 090 4	417,00 €	3,51	1	80	104	300	310	85	204



### U-PVC Yapıştırma Mufllu T Çekvalf

U-PVC T Checkvalve

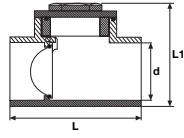

Su için / For Water

Asit için / For Acid

Çap Dia	Basınç PN	FPM Conta Kod FPM O-Ring Code	Fiyat (Adet) Price (Pcs)	FPM Conta Kod FPM O-Ring Code	Fiyat (Adet) Price (Pcs)	Kg/Adet Kg/Pcs	Koli/Adet Box/Pcs	DN (mm)	L (mm)	L1 (mm)
50	10	218 00 050 2	5,50 €	218 01 050 2	7,15 €	0,30	40	40	124	96
63	10	218 00 063 2	7,00 €	218 01 063 2	9,10 €	0,46	22	50	144	112
75	10	218 00 075 2	17,00 €	218 01 075 2	22,10 €		10	65	168	140
90	10	218 00 090 2	25,93 €	218 01 090 2	33,70 €		10	80	195	161

### U-PVC Tek Taraf İç Dişli T Çekvalf

U-PVC One Side Female Threaded T Check Valve

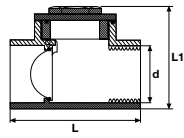

Su için / For Water

Asit için / For Acid

Çap Dia	DN (mm)	Basınç PN	FPM Conta Kod FPM O-Ring Code	Fiyat (Adet) Price (Pcs)	FPM Conta Kod FPM O-Ring Code	Fiyat (Adet) Price (Pcs)	Kg/Adet Kg/Pcs	Koli/Adet Box/Pcs	L (mm)	L1 (mm)
50	1 1/2"	10	219 00 050 2	6,50 €	219 01 050 2	8,45 €	0,32	40	124	96
63	2"	10	219 00 063 2	8,00 €	219 01 063 2	10,40 €	0,49	22	144	112
75	2 1/2"	10	219 00 075 2	18,50 €	219 01 075 2	24,05 €			168	140
90	3"	10	219 00 090 2	27,25 €	219 01 090 2	35,50 €			195	161

### U-PVC Çift Taraf İç Dişli T Çekvalf

U-PVC Both Side Female Threaded T Check Valve

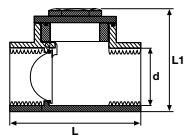

Su için / For Water

Asit için / For Acid

Rp Inch	Basınç PN	FPM Conta Kod FPM O-Ring Code	Fiyat (Adet) Price (Pcs)	FPM Conta Kod FPM O-Ring Code	Fiyat (Adet) Price (Pcs)	Kg/Adet Kg/Pcs	Koli/Adet Box/Pcs	L (mm)	L1 (mm)
1 1/2"	10	219 10 050 2	7,50 €	219 11 050 2	9,75 €	0,30	40	124	96
2"	10	219 10 063 2	9,00 €	219 11 063 2	11,70 €	0,46	22	144	112
2 1/2"	10	219 10 075 2	19,50 €	219 11 075 2	25,35 €			168	140
3"	10	219 10 090 2	28,05 €	219 11 090 2	37,00 €			195	161



### U-PVC Tek Taraf Rakorlu Kuyu Çekvalfi

#### U-PVC Single Union Foot Checkvalve

NEW

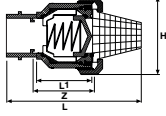

Çap Dia	Basınç PN	EPDM Conta Kod EPDM O-Ring Code	Fiyat (Adet) Price (Pcs)	Kg/Adet Kg/Pcs	Koli/Adet Box/Pcs	DN (mm)	H (mm)	L (mm)	L1 (mm)	Z (mm)
20	16	214 30 020 2	5,25 €		60	16	47	108	45	55
25	16	214 30 025 2	5,75 €		75	20	52	115	49	59
32	16	214 30 032 2	7,15 €		60	25	63	140	54	69
40	16	214 30 040 2	7,85 €		32	32	66	160	66	72
50	16	214 30 050 2	8,85 €		24	40	89	180	75	91
63	16	214 30 063 2	11,75 €		13	50	100	220	89	103
75	16	214 30 075 2	27,50 €		9	65	146	270	111	111
90	16	214 30 090 2	30,50 €		4	80	178	335	125	141
110	16	214 30 110 2	53,50 €		2	100	210	345	155	171

### U-PVC Tek Taraf Rakorlu İç Dişli Kuyu Çekvalfi

#### U-PVC Single Union Female Threaded Foot Checkvalve

NEW

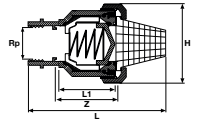

Rp Inch	Basınç PN	EPDM Conta Kod EPDM O-Ring Code	Fiyat (Adet) Price (Pcs)	Kg/Adet Kg/Pcs	Koli/Adet Box/Pcs	DN (mm)	H (mm)	L (mm)	L1 (mm)	Z (mm)
1/2"	16	215 30 020 2	5,85 €		60	16	47	108	45	55
3/4"	16	215 30 025 2	6,35 €		75	20	52	115	49	59
1"	16	215 300 32 2	7,85 €		60	25	63	140	54	69
1 1/4"	16	215 300 40 2	8,55 €		32	32	66	160	66	72
1 1/2"	16	215 300 50 2	9,75 €		24	40	89	180	75	91
2"	16	215 300 63 2	12,65 €		13	50	100	220	89	103
2 1/2"	16	215 300 75 2	29,05 €		9	65	146	270	111	111
3"	16	215 300 90 2	32,05 €		4	80	178	335	125	141
4"	16	215 30 110 2	55,00 €		2	100	210	345	155	171

### U-PVC Yapıştırma Mufllu Kuyu Çekvalfi

#### U-PVC Foot Spring Checkvalve

NEW

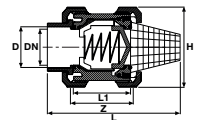

Çap Dia	Basınç PN	EPDM Conta Kod EPDM O-Ring Code	Fiyat (Adet) Price (Pcs)	Kg/Adet Kg/Pcs	Koli/Adet Box/Pcs	DN (mm)	H (mm)	L (mm)	L1 (mm)	Z (mm)
20	16	217 03 020 2	4,42 €		60	16	54	108	48	55
25	16	217 03 025 2	4,68 €		75	20	62	115	52	60
32	16	217 03 032 2	5,53 €		60	25	66	140	56	64
40	16	217 03 040 2	5,95 €		32	32	84	160	70	77
50	16	217 03 050 2	6,97 €		24	40	92	180	77	84
63	16	217 03 063 2	9,18 €		13	50	116	220	90	98
75	16	217 03 075 2	25,50 €		9	65	146	270	102	111
90	16	217 03 090 2	29,05 €		4	80	178	335	128	141
110	16	217 03 110 2	50,10 €		2	100	210	345	159	171

### U-PVC İçten Dişli Kuyu Çekvalfi

#### U-PVC Female Threaded Spring Foot Checkvalve

NEW

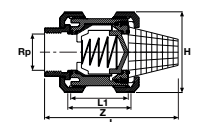

Rp Inch	Basınç PN	EPDM Conta Kod EPDM O-Ring Code	Fiyat (Adet) Price (Pcs)	Kg/Adet Kg/Pcs	Koli/Adet Box/Pcs	DN (mm)	H (mm)	L (mm)	L1 (mm)	Z (mm)
1/2"	16	217 04 020 2	5,30 €		60	16	54	108	48	55
3/4"	16	217 04 025 2	5,65 €		75	20	62	115	52	60
1"	16	217 04 032 2	6,78 €		60	25	66	140	56	64
1 1/4"	16	217 04 040 2	7,22 €		32	32	84	160	70	77
1 1/2"	16	217 04 050 2	8,26 €		24	40	92	180	77	84
2"	16	217 04 063 2	10,52 €		13	50	116	220	90	98
2 1/2"	16	217 04 075 2	27,00 €		9	65	146	270	102	111
3"	16	217 04 090 2	31,50 €		4	80	178	335	128	141
4"	16	217 04 110 2	52,10 €		2	100	210	345	159	171



**U-PVC Atık Su Çekvalfi**  
Anti-Flooding Valve

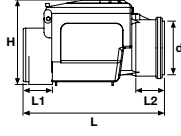

Çap Dia	Basınç PN	Kod Code	Fiyat (Adet) Price (Pcs)	Kg/Adet Kg/Pcs	Koli/Adet Box/Pcs	H (mm)	L (mm)	L1 (mm)	L2 (mm)
110	10	533 00 100 2	25,00 €	2,720	1	255	366	59	56
125	10	533 00 125 2	30,00 €	2,780	1	255	388	69	69
160	10	533 00 150 2	35,00 €	2,880	1	255	442	96	93



**Klape kilitleme ayar kolu**  
(Açık / kapalı konumlar için)  
Flap lock adjustment knob  
(For open / close positions)



**Özel tasarım denge terazisi**  
Special desing water balance scale



**Özel kapak kilitleme kolu**  
Special cover lock handle

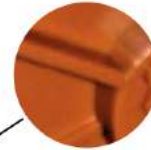

**Federler ile güçlendirilmiş kapak**  
Cover fortified with extra supports



**Klape kilitleme mandalı**  
(Bağlantı pimi sızdırmazlığı O-Ring ile sağlar)  
Lock latch (Leak-Tightness of connection pin is provided by O-Ring)



**U-PVC Kapak pimi ve özel tasarım kapak contası**  
U-PVC Cover pin and special design cover gasket

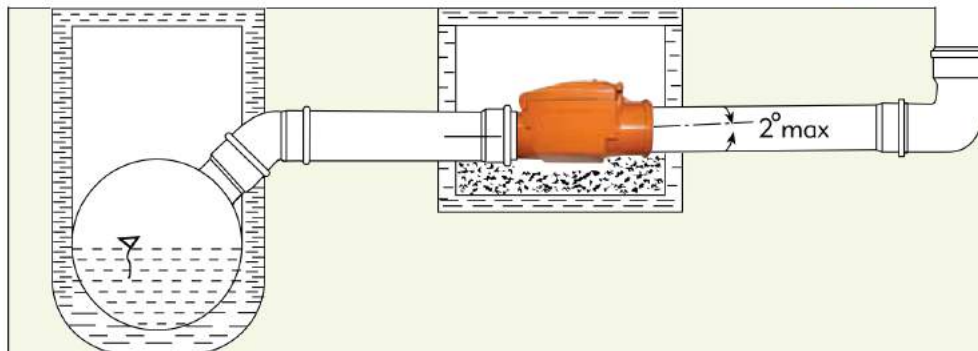



**U-PVC**  
**KELEBEK VANA**  
BUTTERFLY VALVES

**ÜRETİM STANDARDI / PRODUCTION STANDARD**

**TS EN ISO 16136**  
**ÇAP / SIZE Ø63 - Ø400**

**U-PVC Kelebek Vana (Çıplak)**  
U-PVC Butterfly Valve (Without Flange)

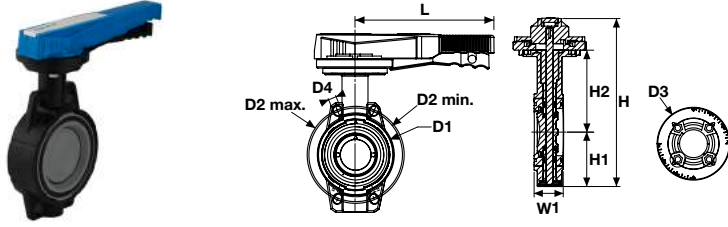

Çap Dia	DN	D1 (mm)	D2 min. (mm)	D2 max. (mm)	D3 (mm)	D4 (mm)	L (mm)	H (mm)	H1 (mm)	H2 (mm)	W1 (mm)	nØe	kv-value l/min.	ISO 5211 ISO 5211
63	50	104	120	125	115	19	207	256	82	126	45	4 x 19	1470	F 07
75	65	115	140	145	115	19	207	265	86	129	46	4 x 19	2200	F 07
90	80	131	150	160	115	19	207	272	89	132	48	8 x 19	3000	F 07
110	100	160	175	190	115	19	207	311	103	156	56	8 x 19	6500	F 07
125	110	190	210	216	115	23	258	338	116	169	63	8 x 23	11500	F 07
140	125	190	210	216	115	23	258	338	116	169	63	8 x 23	11500	F 07
160	150	214	241	241	115	24	258	364	129	182	66	8 x 24	16600	F 07
200	175	268	290	295	115	24	335	414	158	203	75	8 x 24	39600	F 07
225	200	268	290	295	115	24	335	414	158	203	75	8 x 24	39600	F 07
250	250	333	353	362	156	24	410	507	198	242	114	8 x 24	55200	F 10
280	250	333	353	362	156	24	410	507	198	242	114	12 x 24	55200	F 10
315	300	379	400	432	156	24	410	580	228	285	113	12 x 24	80000	F 10
*355	350	535	445	477	156	26	410	620	268	305	140	16 x 24	90000	F 12
*400	400	595	510	540	156	26	410	686	285	335	168	16 x 26	115000	F 12

\* Redüktör Dişli Kelebek Vana / Reduction Gear Butterfly Valve

Su İçin / For Water

Asit İçin / For Acid

Çap Dia	Basınç PN	EPDM Conta Kod EPDM O-Ring Code	Fiyat (Adet) Price (Pcs)	FPM Conta Kod FPM O-Ring Code	Fiyat (Adet) Price (Pcs)	Kg /Adet Kg/Pcs	Koli/Ad. Box/Pcs
63	10	201 00 063 4	41,00 €	201 01 063 4	61,50 €	1,18	1
75	10	201 00 075 4	45,00 €	201 01 075 4	67,50 €	1,26	1
90	10	201 00 090 4	48,00 €	201 01 090 4	72,00 €	1,42	1
110	10	201 00 110 4	55,00 €	201 01 110 4	82,50 €	2,23	1
125	10	201 00 125 4	62,00 €	201 01 125 4	93,00 €	2,77	1
140	10	201 00 140 4	62,00 €	201 01 140 4	93,00 €	2,77	1
160	10	201 00 160 4	79,00 €	201 01 160 4	118,50 €	3,22	1
200	10	201 00 200 4	132,00 €	201 01 200 4	198,00 €	5,12	1
225	10	201 00 225 4	132,00 €	201 01 225 4	198,00 €	5,12	1
250	10	201 00 250 4	350,00 €	201 01 250 4	525,00 €	9,14	1
280	10	201 00 280 4	350,00 €	201 01 280 4	525,00 €	9,14	1
315	10	201 00 315 4	900,00 €	201 01 315 4	1,350,00 €	24,3	1
*355	6	201 00 355 4	1.895,00 €	201 01 355 4	☹	?	1
*400	6	201 00 400 4	1.895,00 €	201 01 400 4	☹	?	1



## U-PVC Flanşlı Kelebek Vana (Takım)

### U-PVC Butterfly Valve With Flange Adaptor

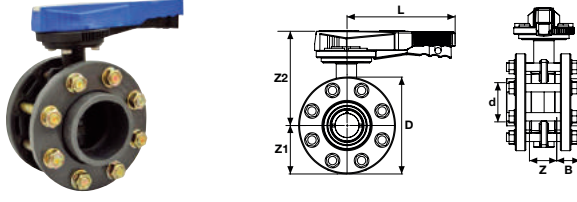

Çap Dia	DN	D (mm)	Z (mm)	Z1 (mm)	Z2 (mm)	B (mm)	L (mm)	Q1 (mm)	Q2 (mm)	nØe	ISO 5211 ISO 5211	kv-value l/min.	Basınç PN	Kg /Adet Kg/Pcs	Koli/Ad. Box/Pcs
63	50	165	51	82	188	38	207	37		4 x 19	F 07	1470	10	3,00	1
75	65	185	52	92	180	43	207	50	40	4 x 19	F 07	2200	10	5,00	1
90	80	200	58	100	183	51	207	65	46	8 x 19	F 07	3000	10	6,60	1
110	100	220	66	110	208	60	258	85	68	8 x 19	F 07	6500	10	6,60	1
125	110	250	73	125	221	69	258	111	92	8 x 23	F 07	11500	10	9,50	1
140	125	250	73	125	221	75	258	111	92	8 x 23	F 07	11500	10	9,90	1
160	150	285	76	142	235	86	258	138	122	8 x 24	F 07	16600	10	11,4	1
200	175	340	87	170	255	106	335	192	179	8 x 24	F 07	39600	10	17,1	1
225	200	340	87	170	255	120	335	192	179	8 x 24	F 07	39600	10	36,7	1
250	250	395	123	198	309	131	410	223	209	8 x 24	F 10	55200	10	36,7	1
280	250	395	119	198	309	146	410	223	209	12 x 24	F 10	55200	10	39,2	1
315	300	445	121	228	370	164	410	256	253	12 x 24	F 10	80000	10	44,5	1
*355	350	505	140	255	372	185	410	325	305	16 x 24	F 12	90000	6		1
*400	400	565	169	285	402	206	410	353	350	16 x 26	F 12	115000	6		1

\* Redüktör Dişli Kelebek Vana / Reduction Gear Butterfly Valve

## Su İçin / For Water

## Asit İçin / For Acid

Çap Dia	Basınç PN	EPDM Conta Kod EPDM O-Ring Code	Fiyat (Adet) Price (Pcs)	FPM Conta Kod FPM O-Ring Code	Fiyat (Adet) Price (Pcs)	Kg /Adet Kg/Pcs	Koli/Ad. Box/Pcs
63	10	200 00 063 2	60,00 €	200 01 063 4	90,00 €	3,00	1
75	10	200 00 075 2	65,00 €	200 01 075 4	97,50 €	5,00	1
90	10	200 00 090 2	72,00 €	200 01 090 4	108,00 €	6,60	1
110	10	200 00 110 2	81,00 €	200 01 110 4	121,50 €	6,60	1
125	10	200 00 125 2	95,00 €	200 01 125 4	142,50 €	9,50	1
140	10	200 00 140 2	95,00 €	200 01 140 4	142,50 €	9,90	1
160	10	200 00 160 2	139,00 €	200 01 160 4	208,50 €	11,4	1
200	10	200 00 200 2	195,00 €	200 01 200 4	292,50 €	17,1	1
225	10	200 00 225 2	199,00 €	200 01 225 4	298,50 €	36,7	1
250	10	200 00 250 2	505,00 €	200 01 250 4	757,00 €	36,7	1
280	10	200 00 280 2	520,00 €	200 01 280 4	780,00 €	39,2	1
315	10	200 00 315 2	1.200,00 €	200 01 315 4	1.725,00 €	44,5	1
*355	6	200 00 355 2	2.600,00 €	200 01 355 4			1
*400	6	200 00 400 2	2.600,00 €	200 01 400 4			1

## 304 Paslanmaz Civata-Somun-Pul / 304.S.S.Screw,Nut,Washer

## 316 Paslanmaz Civata-Somun-Pul / 316.S.S.Screw,Nut,Washer

## Su İçin / For Water

## Asit İçin / For Acid

## Su İçin / For Water

## Asit İçin / For Acid

Çap Dia	EPDM Conta Kod EPDM O-Ring Code	Fiyat (Adet) Price (Pcs)	FPM Conta Kod FPM O-Ring Code	Fiyat (Adet) Price (Pcs)
63	200 02 063 4	84,00 €	200 03 063 4	109,20 €
75	200 02 075 4	91,00 €	200 03 075 4	118,30 €
90	200 02 090 4	100,80 €	200 03 090 4	131,04 €
110	200 02 110 4	119,00 €	200 03 110 4	154,70 €
125	200 02 125 4	133,00 €	200 03 125 4	172,90 €
140	200 02 140 4	133,00 €	200 03 140 4	172,90 €
160	200 02 160 4	194,60 €	200 03 160 4	252,98 €
200	200 02 200 4	273,00 €	200 03 200 4	354,90 €
225	200 02 225 4	278,60 €	200 03 225 4	362,18 €
250	200 02 250 4	707,00 €	200 03 250 4	919,10 €
280	200 02 280 4	728,00 €	200 03 280 4	964,60 €
315	200 02 315 4	1.610,00 €	200 03 315 4	2.093,00 €
355	200 02 355 4	3.200,00 €	200 03 355 4	☹
400	200 02 400 4	3.200,00 €	200 03 400 4	☹

Çap Dia	EPDM Conta Kod EPDM O-Ring Code	Fiyat (Adet) Price (Pcs)	FPM Conta Kod FPM O-Ring Code	Fiyat (Adet) Price (Pcs)
63	200 04 063 4	126,00 €	200 05 063 4	176,40 €
75	200 04 075 4	136,50 €	200 05 075 4	191,10 €
90	200 04 090 4	151,20 €	200 05 090 4	211,68 €
110	200 04 110 4	178,50 €	200 05 110 4	249,90 €
125	200 04 125 4	199,50 €	200 05 125 4	279,30 €
140	200 04 140 4	199,50 €	200 05 140 4	279,30 €
160	200 04 160 4	291,90 €	200 05 160 4	408,66 €
200	200 04 200 4	409,50 €	200 05 200 4	573,30 €
225	200 04 225 4	417,90 €	200 05 225 4	585,06 €
250	200 04 250 4	1.060,50 €	200 05 250 4	1.484,70 €
280	200 04 280 4	1.092,50 €	200 05 280 4	1.528,80 €
315	200 04 315 4	2.415,00 €	200 05 315 4	3.381,00 €
355	200 04 355 4	3.800,00 €	200 05 355 4	☹
400	200 04 400 4	3.800,00 €	200 05 400 4	☹

**U-PVC Redüktör Dişli Kelebek Vana (Çıplak)**

U-PVC Reduction Gear Butterfly Valve With Handwheel (Without Flange)

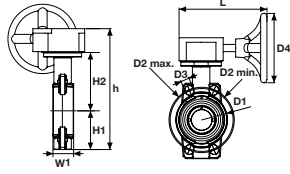

Çap Dia	DN	D1 (mm)	D2 min. (mm)	D2 max. (mm)	D3 (mm)	D4 (mm)	L (mm)	H (mm)	H1 (mm)	H2 (mm)	W1 (mm)	nØe	kv-value l/min.	ISO 5211 ISO 5211
63	50	104	120	125	115	19	192	279	82	126	45	4 x 19	1470	F 07
75	65	115	140	145	115	19	192	288	86	129	46	4 x 19	2200	F 07
90	80	131	150	160	115	19	192	290	89	132	48	8 x 19	3000	F 07
110	100	160	175	190	115	19	192	337	103	156	56	8 x 19	6500	F 07
125	110	190	210	216	115	23	192	353	116	169	63	8 x 23	11500	F 07
140	125	190	210	216	115	23	192	353	116	169	63	8 x 23	11500	F 07
160	150	214	241	241	115	24	192	375	129	182	66	8 x 24	16600	F 07
200	175	268	290	295	115	24	192	429	158	203	75	8 x 24	39600	F 07
225	200	268	290	295	115	24	192	429	158	203	75	8 x 24	39600	F 07
250	250	333	353	362	156	24	250	485	198	242	114	8 x 24	55200	F 10
280	250	333	353	362	156	24	250	485	198	242	114	12 x 24	55200	F 10
315	300	379	400	432	156	24	250	581	228	285	113	12 x 24	80000	F 10
355	350	535	445	477	156	26	250	581	268	305	140	16 x 24	90000	F 12
400	400	595	510	540	156	26	250	581	285	335	168	16 x 26	115000	F 12

Su İçin / For Water

Asit İçin / For Acid

Çap Dia	Basınç PN	EPDM Conta Kod EPDM O-Ring Code	Fiyat (Adet) Price (Pcs)	FPM Conta Kod FPM O-Ring Code	Fiyat (Adet) Price (Pcs)	Kg /Adet Kg/Pcs	Koli/Ad. Box/Pcs
63	10	201 11 063 4	71,00 €	201 02 063 4	91,50 €		1
75	10	201 11 075 4	75,00 €	201 02 075 4	87,50 €		1
90	10	201 11 090 4	78,00 €	201 02 090 4	102,00 €		1
110	10	201 11 110 4	85,00 €	201 02 110 4	112,50 €		1
125	10	201 11 125 4	92,00 €	201 02 125 4	123,00 €		1
140	10	201 11 140 4	92,00 €	201 02 140 4	127,00 €		1
160	10	201 11 160 4	109,00 €	201 02 160 4	148,50 €		1
200	10	201 11 200 4	162,00 €	201 02 200 4	228,00 €		1
225	10	201 11 225 4	162,00 €	201 02 225 4	228,00 €		1
250	10	201 11 250 4	400,00 €	201 02 250 4	975,00 €		1
280	10	201 11 280 4	420,00 €	201 02 280 4	1,025,00 €		1
315	10	201 11 315 4	950,00 €	201 02 315 4	1,400,00 €		1
355	6	201 11 355 4	1,895,00 €	201 02 355 4	☎		1
400	6	201 11 400 4	1,895,00 €	201 02 400 4	☎		1



## U-PVC Redüktör Dişli Flanşlı Kelebek Vana (Takım)

U-PVC Reduction Gear Butterfly Valve With Handwheel and Flange

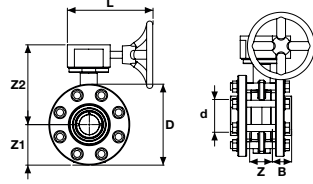

Çap Dia	DN	D (mm)	Z (mm)	Z1 (mm)	Z2 (mm)	B (mm)	L (mm)	Q1 (mm)	Q2 (mm)	nØe	ISO 5211 ISO 5211	kv-value l/min.
63	50	165	51	82	196	38	192	37		4 x 19	F 07	1470
75	65	185	52	92	191	43	192	50	40	4 x 19	F 07	2200
90	80	200	58	100	190	51	192	65	46	8 x 19	F 07	3000
110	100	220	66	110	227	60	192	85	68	8 x 19	F 07	6500
125	110	250	73	125	228	69	192	111	92	8 x 23	F 07	11500
140	125	250	73	125	228	75	192	111	92	8 x 23	F 07	11500
160	150	285	76	142	232	86	192	138	122	8 x 24	F 07	16600
200	175	340	87	170	259	106	192	192	179	8 x 24	F 07	39600
225	200	340	87	170	259	120	192	192	179	8 x 24	F 07	39600
250	250	395	123	198	287	131	250	223	209	8 x 24	F 10	55200
280	250	395	119	198	287	146	250	223	209	12 x 24	F 10	55200
315	300	445	121	228	353	164	250	256	253	12 x 24	F 10	80000
355	350	505	140	255	372	185	300	325	305	16 x 24	F 12	90000
400	400	565	169	285	402	206	300	353	350	16 x 26	F 12	115000

Su için / For Water

Asit için / For Acid

Çap Dia	Basınç PN	EPDM Conta Kod EPDM O-Ring Code	Fiyat (Adet) Price (Pcs)	FPM Conta Kod FPM O-Ring Code	Fiyat (Adet) Price (Pcs)	Kg /Adet Kg/Pcs	Koli/Ad. Box/Pcs
63	10	201 03 063 4	80,00 €	201 09 063 4	120,00 €	3,00	1
75	10	201 03 075 4	95,00 €	201 09 075 4	127,50 €	3,60	1
90	10	201 03 090 4	102,00 €	201 09 090 4	138,00 €	5,45	1
110	10	201 03 110 4	111,00 €	201 09 110 4	151,50 €	6,60	1
125	10	201 03 125 4	125,00 €	201 09 125 4	172,50 €	9,50	1
140	10	201 03 140 4	125,00 €	201 09 140 4	172,50 €	9,90	1
160	10	201 03 160 4	169,00 €	201 09 160 4	238,50 €	11,4	1
200	10	201 03 200 4	225,00 €	201 09 200 4	245,20 €	17,1	1
225	10	201 03 225 4	229,00 €	201 09 225 4	348,50 €	17,1	1
250	10	201 03 250 4	555,00 €	201 09 250 4	807,50 €	36,7	1
280	10	201 03 280 4	570,00 €	201 09 280 4	830,00 €		1
315	10	201 03 315 4	1.200,00 €	201 09 315 4	1.795,00 €	44,5	1
355	6	201 03 355 4	2.600,00 €	201 09 355 4	☎		1
400	6	201 03 400 4	2.600,00 €	201 09 400 4	☎		1

### 304 Paslanmaz Civata-Somun-Pul / 304.S.S.Screw,Nut,Washer

Su için / For Water

Asit için / For Acid

Çap Dia	EPDM Conta Kod EPDM O-Ring Code	Fiyat (Adet) Price (Pcs)	FPM Conta Kod FPM O-Ring Code	Fiyat (Adet) Price (Pcs)
63	201 05 063 4	114,00 €	201 06 063 4	139,20 €
75	201 05 075 4	121,00 €	201 06 075 4	148,30 €
90	201 05 090 4	130,80 €	201 06 090 4	161,04 €
110	201 05 110 4	149,00 €	201 06 110 4	184,70 €
125	201 05 125 4	163,00 €	201 06 125 4	202,90 €
140	201 05 140 4	163,00 €	201 06 140 4	202,90 €
160	201 05 160 4	224,60 €	201 06 160 4	282,98 €
200	201 05 200 4	303,00 €	201 06 200 4	384,90 €
225	201 05 225 4	308,60 €	201 06 225 4	392,18 €
250	201 05 250 4	757,00 €	201 06 250 4	969,10 €
280	201 05 280 4	778,00 €	201 06 280 4	1.034,60 €
315	201 05 315 4	1.660,00 €	201 06 315 4	2.143,00 €
355	201 05 355 4	3.200,00 €	201 06 355 4	☎
400	201 05 400 4	3.200,00 €	201 06 400 4	☎

### 316 Paslanmaz Civata-Somun-Pul / 316.S.S.Screw,Nut,Washer

Su için / For Water

Asit için / For Acid

Çap Dia	EPDM Conta Kod EPDM O-Ring Code	Fiyat (Adet) Price (Pcs)	FPM Conta Kod FPM O-Ring Code	Fiyat (Adet) Price (Pcs)
63	201 07 063 4	156,00 €	201 08 063 4	206,40 €
75	201 07 075 4	166,50 €	201 08 075 4	221,10 €
90	201 07 090 4	181,20 €	201 08 090 4	241,68 €
110	201 07 110 4	208,50 €	201 08 110 4	279,90 €
125	201 07 125 4	229,50 €	201 08 125 4	309,30 €
140	201 07 140 4	229,50 €	201 08 140 4	309,30 €
160	201 07 160 4	321,90 €	201 08 160 4	438,66 €
200	201 07 200 4	439,50 €	201 08 200 4	603,30 €
225	201 07 225 4	447,90 €	201 08 225 4	615,05 €
250	201 07 250 4	1.140,50 €	201 08 250 4	1.534,70 €
280	201 07 280 4	1.162,00 €	201 08 280 4	1.598,80 €
315	201 07 315 4	2.465,00 €	201 08 315 4	3.431,00 €
355	201 07 355 4	3.800,00 €	201 08 355 4	☎
400	201 07 400 4	3.800,00 €	201 08 400 4	☎









## U-PVC AKTÜATÖRLÜ KELEBEK VANA ACTUATOR BUTTERFLY VALVE

ÜRETİM STANDARDI / PRODUCTION STANDARD

TS EN ISO 16136  
ÇAP / SIZE Ø20 - Ø400



**U-PVC Aktüatör Uyumlu Kelebek Vana (Çıplak)**  
*U-PVC Actuator Butterfly Valves (Without Flange)*

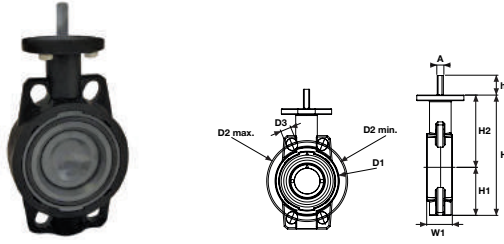

Çap Dia	DN (mm)	D1 (mm)	D2 min. (mm)	D2 max. (mm)	D3 (mm)	H (mm)	H1 (mm)	H2 (mm)	W1 (mm)	A (mm)	h (mm)	nØe	kv-value l/min.	ISO 5211 ISO 5211
63	50	104	120	125	19	256	82	126	45	11	15	4 x 19	1470	F 07
75	65	115	140	145	19	265	86	129	46	11	15	4 x 19	2200	F 07
90	80	131	150	160	19	272	89	132	48	11	15	8 x 19	3000	F 07
110	100	160	175	190	19	311	103	156	56	14	15	8 x 19	6500	F 07
125	110	190	210	216	23	338	116	169	63	14	15	8 x 23	11500	F 07
140	125	190	210	216	23	338	116	169	63	14	15	8 x 23	11500	F 07
160	150	214	241	241	24	364	129	182	66	14	15	8 x 24	16600	F 07
200	175	268	290	295	24	414	158	203	75	17	15	8 x 24	39600	F 07
225	200	268	290	295	24	414	158	203	75	17	15	8 x 24	39600	F 07
250	250	333	353	362	24	507	198	242	114	17	20	8 x 24	55200	F 10
280	250	333	353	362	24	507	198	242	114	17	20	12 x 24	55200	F 10
315	300	379	400	432	24	580	228	285	113	22	20	12 x 24	80000	F 10
355	350	535	445	477	26	620	268	305	140	22	20	16 x 24	90000	F 12
400	400	595	510	540	26	686	285	335	168	22	20	16 x 26	115000	F 12

*Su İçin / For Water*

*Asit İçin / For Acid*

Çap Dia	Basınç PN	EPDM Conta Kod EPDM O-Ring Code	Fiyat (Adet) Price (Pcs)	FPM Conta Kod FPM O-Ring Code	Fiyat (Adet) Price (Pcs)	Kg /Adet Kg/Pcs	Koli/Ad. Box/Pcs
63	10	300 00 063 4	38,95 €	300 01 063 4	58,43 €	0,89	1
75	10	300 00 075 4	42,75 €	300 01 075 4	64,13 €		1
90	10	300 00 090 4	45,60 €	300 01 090 4	68,40 €		1
110	10	300 00 110 4	52,25 €	300 01 110 4	78,38 €		1
125	10	300 00 125 4	58,90 €	300 01 125 4	88,35 €		1
140	10	300 00 140 4	58,90 €	300 01 140 4	88,35 €		1
160	10	300 00 160 4	75,05 €	300 01 160 4	112,58 €		1
200	10	300 00 200 4	125,40 €	300 01 200 4	188,10 €		1
225	10	300 00 225 4	125,40 €	300 01 225 4	188,10 €		1
250	10	300 00 250 4	332,50 €	300 01 250 4	498,75 €	30,5	1
280	10	300 00 280 4	332,50 €	300 01 280 4	498,75 €		1
315	10	300 00 315 4	855,00 €	300 01 315 4	1.282,50 €		1
355	6	300 00 355 4	☞	300 01 355 4	☞		1
400	6	300 00 400 4	☞	300 01 400 4	☞		1



## U-PVC Aktüatör Uyumlu Kelebek Vana (Takım)

U-PVC Butterfly Valve Actuator Compatible (With Flange Adaptor)

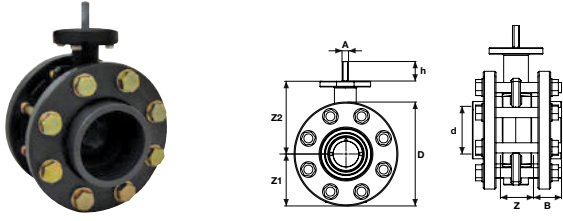

Çap Dia	DN (mm)	D (mm)	Z (mm)	Z1 (mm)	Z2 (mm)	B (mm)	Q1 (mm)	Q2 (mm)	A (mm)	h (mm)	nØe	ISO 5211 ISO 5211	kv-value l/min.
63	50	54	51	82	188	38	37	-	11	15	4 x 19	F 07	1470
75	65	57	52	92	180	43	50	40	11	15	4 x 19	F 07	2200
90	80	131	58	100	183	51	65	46	11	15	8 x 19	F 07	3000
110	100	160	66	110	208	60	85	68	14	15	8 x 19	F 07	6500
125	110	190	73	125	221	69	111	92	14	15	8 x 23	F 07	11500
140	125	190	73	125	221	75	111	92	14	15	8 x 23	F 07	11500
160	150	214	76	142	235	86	138	122	14	15	8 x 24	F 07	16600
200	175	268	87	170	255	106	192	179	17	15	8 x 24	F 07	39600
225	200	268	87	170	255	120	192	179	17	15	8 x 24	F 07	39600
250	250	333	123	198	309	131	223	209	17	20	8 x 24	F 10	55200
280	250	333	119	198	309	146	223	209	17	20	12 x 24	F 10	55200
315	300	379	121	228	370	164	256	253	22	20	12 x 24	F 10	80000
355	350	505	140	255	372	185	325	305	22	20	16 x 24	F 12	90000
400	400	565	169	285	402	206	353	350	22	20	16 x 26	F 12	115000

### Su İçin / For Water

### Asit İçin / For Acid

Çap Dia	Basınç PN	EPDM Conta Kod EPDM O-Ring Code	Fiyat (Adet) Price (Pcs)	FPM Conta Kod FPM O-Ring Code	Fiyat (Adet) Price (Pcs)	Kg /Adet Kg/Pcs	Koli/Ad. Box/Pcs
63	10	301 00 063 4	57,00 €	301 01 063 4	85,50 €		1
75	10	301 00 075 4	61,75 €	301 01 075 4	92,63 €		1
90	10	301 00 090 4	68,40 €	301 01 090 4	102,60 €		1
110	10	301 00 110 4	80,75 €	301 01 110 4	115,43 €		1
125	10	301 00 125 4	90,25 €	301 01 125 4	135,38 €		1
140	10	301 00 140 4	90,25 €	301 01 140 4	135,38 €		1
160	10	301 00 160 4	132,05 €	301 01 160 4	198,08 €		1
200	10	301 00 200 4	185,25 €	301 01 200 4	277,88 €		1
225	10	301 00 225 4	189,05 €	301 01 225 4	283,58 €		1
250	10	301 00 250 4	479,75 €	301 01 250 4	719,15 €		1
280	10	301 00 280 4	494,00 €	301 01 280 4	741,00 €		1
315	10	301 00 315 4	1.092,50 €	301 01 315 4	1.638,75 €		1
355	6	301 00 355 4	☞	301 01 355 4	☞		1
400	6	301 00 400 4	☞	301 01 400 4	☞		1

### 304 Paslanmaz Civata-Somun-Pul / 304.S.S.Screw,Nut,Washer

#### Su İçin / For Water

#### Asit İçin / For Acid

Çap Dia	EPDM Conta Kod EPDM O-Ring Code	Fiyat (Adet) Price (Pcs)	FPM Conta Kod FPM O-Ring Code	Fiyat (Adet) Price (Pcs)
63	308 00 063 2	81,48 €	308 10 063 2	105,92 €
75	308 00 075 2	88,27 €	308 10 075 2	114,75 €
90	308 00 090 2	97,78 €	308 10 090 2	127,11 €
110	308 00 110 2	115,43 €	308 10 110 2	150,06 €
125	308 00 125 2	129,01 €	308 10 125 2	167,71 €
140	308 00 140 2	129,01 €	308 10 140 2	167,71 €
160	308 00 160 2	188,76 €	308 10 160 2	245,39 €
200	308 00 200 2	264,81 €	308 10 200 2	344,25 €
225	308 00 225 2	270,24 €	308 10 225 2	351,31 €
250	308 00 250 2	685,79 €	308 10 250 2	891,53 €
280	308 00 280 2	706,16 €	308 10 280 2	935,66 €
315	308 00 315 2	1.561,70 €	308 10 315 2	2.030,21 €
355	308 00 355 2	☞	308 10 355 2	☞
400	308 00 400 2	☞	308 10 400 2	☞

### 316 Paslanmaz Civata-Somun-Pul / 316.S.S.Screw,Nut,Washer

#### Su İçin / For Water

#### Asit İçin / For Acid

Çap Dia	EPDM Conta Kod EPDM O-Ring Code	Fiyat (Adet) Price (Pcs)	FPM Conta Kod FPM O-Ring Code	Fiyat (Adet) Price (Pcs)
63	309 00 063 2	81,48 €	309 10 063 2	105,92 €
75	309 00 075 2	88,27 €	309 10 075 2	114,75 €
90	309 00 090 2	97,78 €	309 10 090 2	127,11 €
110	309 00 110 2	115,43 €	309 10 110 2	150,06 €
125	309 00 125 2	129,01 €	309 10 125 2	167,71 €
140	309 00 140 2	129,01 €	309 10 140 2	167,71 €
160	309 00 160 2	188,76 €	309 10 160 2	245,39 €
200	309 00 200 2	264,81 €	309 10 200 2	344,25 €
225	309 00 225 2	270,24 €	309 10 225 2	351,31 €
250	309 00 250 2	685,79 €	309 10 250 2	891,53 €
280	309 00 280 2	706,16 €	309 10 280 2	935,66 €
315	309 00 315 2	1.561,70 €	309 10 315 2	2.030,21 €
355	309 00 355 2	☞	309 10 355 2	☞
400	309 00 400 2	☞	309 10 400 2	☞



**U-PVC Elektrik Aktüatörlü Kelebek Vana 24 V DC/24 V AC (Çıplak)**  
*U-PVC Butterfly Valve Electric Actuator 24 V DC/24 V AC (Without Flange)*

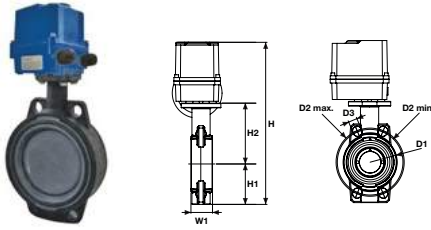

Çap Dia	DN (mm)	D1 (mm)	D2 min. (mm)	D2 max. (mm)	D3 (mm)	H (mm)	H1 (mm)	H2 (mm)	W1 (mm)	nØe	kv-value l/min.	ISO 5211 ISO 5211
63	50	54	120	125	19	446	77	134	45	4 x 19	1470	F 07
75	65	57	140	145	19	451	86	129	46	4 x 19	2200	F 07
90	80	131	150	160	19	457	89	132	48	8 x 19	3000	F 07
110	100	160	175	190	19	504	103	156	56	8 x 19	6500	F 07
125	110	190	210	216	23	520	116	169	63	8 x 23	11500	F 07
140	125	190	210	216	23	520	116	169	63	8 x 23	11500	F 07
160	150	214	241	241	24	546	129	182	66	8 x 24	16600	F 07
200	175	268	290	295	24	596	158	203	75	8 x 24	39600	F 07
225	200	268	290	295	24	596	158	203	75	8 x 24	39600	F 07
250	250	333	341	362	24	748	198	242	114	8 x 24	55200	F 10
280	250	333	341	362	24	748	198	242	114	12 x 24	55200	F 10
315	300	379	400	432	25	923	228	285	113	12 x 24	80000	F 10
355	350	535	445	477	26	620	268	305	140	16 x 24	90000	F 12
400	400	595	510	540	26	686	285	335	168	16 x 26	115000	F 12

*Su İçin / For Water*

*Asit İçin / For Acid*

Çap Dia	Basınç PN	EPDM Conta Kod EPDM O-Ring Code	Fiyat (Adet) Price (Pcs)	FPM Conta Kod FPM O-Ring Code	Fiyat (Adet) Price (Pcs)	Kg /Adet Kg/Pcs	Koli/Ad. Box/Pcs
63	10	302 00 063 4	296,94 €	302 01 063 4	317,44 €		1
75	10	302 00 075 4	296,94 €	302 01 075 4	319,14 €		1
90	10	302 00 090 4	404,84 €	302 01 090 4	428,84 €		1
110	10	302 00 110 4	411,99 €	302 01 110 4	439,49 €		1
125	10	302 00 125 4	706,48 €	302 01 125 4	737,48 €		1
140	10	302 00 140 4	706,48 €	302 01 140 4	737,48 €		1
160	10	302 00 160 4	723,24 €	302 01 160 4	762,74 €		1
200	10	302 00 200 4	800,08 €	302 01 200 4	866,08 €		1
225	10	302 00 225 4	800,08 €	302 01 225 4	866,08 €		1
250	10	302 00 250 4	1.501,36 €	302 01 250 4	1.676,36 €		1
280	10	302 00 280 4	1.501,36 €	302 01 280 4	1.676,36 €		1
315	10	302 00 315 4	2.059,96 €	302 01 315 4	2.509,96 €		1
355	6	302 00 355 4	☎	302 01 355 4	☎		1
400	6	302 00 400 4	☎	302 01 400 4	☎		1

**Opsiyonlar:** Akülü açma/kapama emniyet kumandalı olabilir. Oransal kontrol ünitesi, potansiyometre, lokal kontrol ünitesi, pozisyon transмитeri opsiyonları mevcuttur.

**Boru flanş bağlantı ölçüleri:** EN 1092 PN10, ISO 7005 PN10, ANSI B 16,5 class 150, BS 1560 1958

**Aktüatör flanş bağlantı ölçüleri:** ISO 5211/24V DC - 24V AC.

**Options:** Battery powered on/off can be safety controlled. Option control unit, potentiometer, local control unit, position transmitter options are available.

**Pipe flange connection dimensions:** EN 1092 PN10, ISO 7005 PN10, ANSI B 16,5 class 150, BS 1560 1958

**Actuator flange connection measures:** ISO 5211/24V DC - 24V AC.

## U-PVC Elektrik Aktüatörlü Kelebek Vana 24 V DC/24 V AC (Takım)

### U-PVC Butterfly Valve Electric Actuator 24 V DC/24 V AC (With Flange Adaptor)

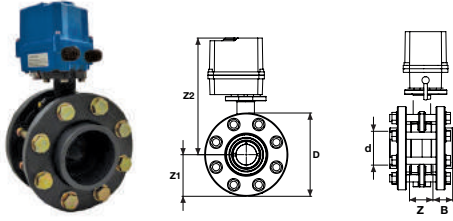

Çap Dia	DN (mm)	D (mm)	Z (mm)	Z1 (mm)	Z2 (mm)	B (mm)	nØe	ISO 5211 ISO 5211
63	50	165	51	83	395	38	4 x 19	F 07
75	65	185	52	93	399	43	4 x 19	F 07
90	80	200	58	100	398	51	8 x 19	F 07
110	100	220	66	110	438	60	8 x 19	F 07
125	110	250	73	125	447	69	8 x 23	F 07
140	125	250	73	125	447	75	8 x 23	F 07
160	150	285	76	143	459	86	8 x 24	F 07
200	175	340	87	170	509	106	8 x 24	F 07
225	200	340	87	170	509	120	8 x 24	F 07
250	250	395	123	198	625	131	8 x 24	F 10
280	250	395	119	198	629	146	12 x 24	F 10
315	300	445	121	228	802	164	12 x 24	F 10
355	350	505	140	255	372	185	16 x 24	F 12
400	400	565	169	285	402	206	16 x 26	F 12

## Su İçin / For Water

## Asit İçin / For Acid

Çap Dia	Basınç PN	EPDM Conta Kod EPDM O-Ring Code	Fiyat (Adet) Price (Pcs)	FPM Conta Kod FPM O-Ring Code	Fiyat (Adet) Price (Pcs)	Kg /Adet Kg/Pcs	Koli/Ad. Box/Pcs
63	10	304 00 063 4	315,94 €	304 01 063 4	345,94 €		1
75	10	304 00 075 4	316,64 €	304 01 075 4	349,14 €		1
90	10	304 00 090 4	428,84 €	304 01 090 4	464,84 €		1
110	10	304 00 110 4	437,99 €	304 01 110 4	478,49 €		1
125	10	304 00 125 4	739,48 €	304 01 125 4	786,98 €		1
140	10	304 00 140 4	739,48 €	304 01 140 4	786,98 €		1
160	10	304 00 160 4	783,24 €	304 01 160 4	852,74 €		1
200	10	304 00 200 4	863,08 €	304 01 200 4	960,58 €		1
225	10	304 00 225 4	867,08 €	304 01 225 4	966,58 €		1
250	10	304 00 250 4	1.656,36 €	304 01 250 4	1.908,86 €		1
280	10	304 00 280 4	1.674,36 €	304 01 280 4	1.931,36 €		1
315	10	304 00 315 4	2.309,96 €	304 01 315 4	2.884,96 €		1
355	6	304 00 355 4	☎	304 01 355 4	☎		1
400	6	304 00 400 4	☎	304 01 400 4	☎		1

**Opsiyonlar:** Akülü açma/kapama emniyet kumandalı olabilir. Oransal kontrol ünitesi, potansiyometre, lokal kontrol ünitesi, pozisyon transмитeri opsiyonları mevcuttur.

**Boru flanş bağlantı ölçüleri:** EN 1092 PN10, ISO 7005 PN10, ANSI B 16,5 class 150, BS 1560 1958

**Aktüatör flanş bağlantı ölçüleri:** ISO 5211/24V DC - 24V AC.

**Options:** Battery powered on/off can be safety controlled. Option control unit, potentiometer, local control unit, position transmitter options are available.

**Pipe flange connection dimensions:** EN 1092 PN10, ISO 7005 PN10, ANSI B 16,5 class 150, BS 1560 1958

**Actuator flange connection measures:** ISO 5211/24V DC - 24V AC.



**U-PVC Elektrik Aktüatörlü Kelebek Vana 24 V DC/24 V AC 304/316 Paslanmaz Civata-Somun-Pul**  
**U-PVC Butterfly Valves With Flange 304/316 S.S. Screw, Nut, Washer Electric Actuator 24 V DC/24 V AC**

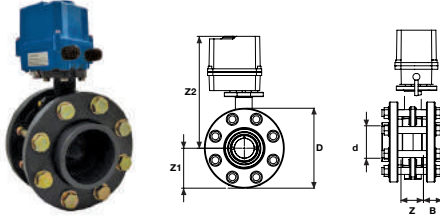

Çap Dia	DN (mm)	D (mm)	Z (mm)	Z1 (mm)	Z2 (mm)	B (mm)	Q1 (mm)	Q2 (mm)	nØe	ISO 5211 ISO 5211	Basınç PN	kv-value l/min.	Kg /Adet Kg/Pcs	Koli/Ad. Box/Pcs
63	50	165	51	82	395	38	37		4 x 19	F 07	10	1470		1
75	65	185	52	92	399	43	50	40	4 x 19	F 07	10	2200		1
90	80	200	58	100	398	51	65	46	8 x 19	F 07	10	3000		1
110	100	220	66	110	438	60	85	68	8 x 19	F 07	10	6500		1
125	110	250	73	125	447	69	111	92	8 x 23	F 07	10	11500		1
140	125	250	73	125	447	75	111	92	8 x 23	F 07	10	11500		1
160	150	285	76	142	459	86	138	122	8 x 24	F 07	10	16600		1
200	175	340	87	170	509	106	192	179	8 x 24	F 07	10	39600		1
225	200	340	87	170	509	120	192	179	8 x 24	F 07	10	39600		1
250	250	395	123	198	625	131	223	209	8 x 24	F 10	10	55200		1
280	250	395	119	198	629	146	223	209	12 x 24	F 10	10	55200		1
315	300	445	121	228	802	164	256	253	12 x 24	F 10	10	80000		1
355	350	505	140	255	372	185	325	305	16 x 24	F 12	6	90000		1
400	400	565	169	285	402	206	353	350	16 x 26	F 12	6	115000		1

**304 Paslanmaz Civata-Somun-Pul / 304.S.S.Screw,Nut,Washer**

**316 Paslanmaz Civata-Somun-Pul / 316.S.S.Screw,Nut,Washer**

Su İçin / For Water

Asit İçin / For Acid

Su İçin / For Water

Asit İçin / For Acid

Çap Dia	EPDM Conta Kod EPDM O-Ring Code	Fiyat (Adet) Price (Pcs)	FPM Conta Kod FPM O-Ring Code	Fiyat (Adet) Price (Pcs)
63	306 00 063 4	339,94 €	306 01 063 4	365,14 €
75	306 00 075 4	342,64 €	306 01 075 4	369,94 €
90	306 00 090 4	457,64 €	306 01 090 4	488,24 €
110	306 00 110 4	470,39 €	306 01 110 4	504,41 €
125	306 00 125 4	777,48 €	306 01 125 4	817,38 €
140	306 00 140 4	777,48 €	306 01 140 4	817,38 €
160	306 00 160 4	838,84 €	306 01 160 4	897,22 €
200	306 00 200 4	941,08 €	306 01 200 4	1022,98 €
225	306 00 225 4	946,68 €	306 01 225 4	1030,26 €
250	306 00 250 4	1858,36 €	306 01 250 4	2070,46 €
280	306 00 280 4	1879,36 €	306 01 280 4	2115,96 €
315	306 00 315 4	2769,96 €	306 01 315 4	3552,96 €
355	306 00 355 4	☎	306 01 355 4	☎
400	306 00 400 4	☎	306 01 400 4	☎

Çap Dia	EPDM Conta Kod EPDM O-Ring Code	Fiyat (Adet) Price (Pcs)	FPM Conta Kod FPM O-Ring Code	Fiyat (Adet) Price (Pcs)
63	308 00 063 4	381,94 €	308 01 063 4	432,34 €
75	308 00 075 4	388,14 €	308 01 075 4	442,74 €
90	308 00 090 4	508,04 €	308 01 090 4	568,52 €
110	308 00 110 4	535,49 €	308 01 110 4	606,89 €
125	308 00 125 4	843,98 €	308 01 125 4	923,78 €
140	308 00 140 4	843,98 €	308 01 140 4	923,78 €
160	308 00 160 4	936,14 €	308 01 160 4	1052,90 €
200	308 00 200 4	1077,58 €	308 01 200 4	1241,38 €
225	308 00 225 4	1085,98 €	308 01 225 4	1253,14 €
250	308 00 250 4	2211,86 €	308 01 250 4	2636,06 €
280	308 00 280 4	2243,36 €	308 01 280 4	2680,16 €
315	308 00 315 4	3574,96 €	308 01 315 4	4540,96 €
355	308 00 355 4	☎	308 01 355 4	☎
400	308 00 400 4	☎	308 01 400 4	☎

**Opsiyonlar:** Akülü açma/kapama emniyet kumandalı olabilir. Oransal kontrol ünitesi, potansiyometre, lokal kontrol ünitesi, pozisyon transмитeri opsiyonları mevcuttur.

**Boru flanş bağlantı ölçüleri:** EN 1092 PN10, ISO 7005 PN10, ANSI B 16,5 class 150, BS 1560 1958

**Aktüatör flanş bağlantı ölçüleri:** ISO 5211/24V DC - 24V AC.

**Options:** Battery powered on/off can be safety controlled. Option control unit, potentiometer, local control unit, position transmitter options are available.

**Pipe flange connection dimensions:** EN 1092 PN10, ISO 7005 PN10, ANSI B 16,5 class 150, BS 1560 1958

**Actuator flange connection measures:** ISO 5211/24V DC - 24V AC.

## U-PVC Elektrik Aktüatörlü Kelebek Vana 100-260 V AC (Çıplak)

### U-PVC Butterfly Valves Electric Actuator 100 -260 V AC ( With Out Flange)

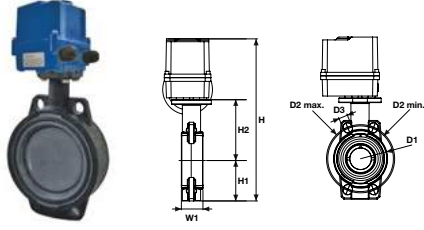

Çap Dia	DN (mm)	D (mm)	Z (mm)	Z1 (mm)	Z2 (mm)	B (mm)	nØe	ISO 5211 ISO 5211
63	50	165	51	83	395	38	4 x 19	F 07
75	65	185	52	93	399	43	4 x 19	F 07
90	80	200	58	100	398	51	8 x 19	F 07
110	100	220	66	110	438	60	8 x 19	F 07
125	110	250	73	125	447	69	8 x 23	F 07
140	125	250	73	125	447	75	8 x 23	F 07
160	150	285	76	143	459	86	8 x 24	F 07
200	175	340	87	170	509	106	8 x 24	F 07
225	200	340	87	170	509	120	8 x 24	F 07
250	250	395	123	198	625	131	8 x 24	F 10
280	250	395	119	198	629	146	12 x 24	F 10
315	300	445	121	228	802	164	12 x 24	F 10
355	350	505	140	255	372	185	16 x 24	F 12
400	400	565	169	285	402	206	16 x 26	F 12

Su için / For Water

Asit için / For Acid

Çap Dia	Basınç PN	EPDM Conta Kod EPDM O-Ring Code	Fiyat (Adet) Price (Pcs)	FPM Conta Kod FPM O-Ring Code	Fiyat (Adet) Price (Pcs)	Kg /Adet Kg/Pcs	Koli/Ad. Box/Pcs
63	10	303 00 063 1	298,20 €	303 10 063 1	317,44 €		1
75	10	303 00 075 1	296,94 €	303 10 075 1	319,14 €		1
90	10	303 00 090 1	404,84 €	303 10 090 1	428,84 €		1
110	10	303 00 110 1	411,99 €	303 10 110 1	439,49 €		1
125	10	303 00 125 1	706,48 €	303 10 125 1	737,48 €		1
140	10	303 00 140 1	706,48 €	303 10 140 1	737,48 €		1
160	10	303 00 160 1	723,24 €	303 10 160 1	762,74 €		1
200	10	303 00 200 1	800,08 €	303 10 200 1	866,08 €		1
225	10	303 00 225 1	800,08 €	303 10 225 1	866,08 €		1
250	10	303 00 250 1	1501,36 €	303 10 250 1	1676,36 €		1
280	10	303 00 280 1	1501,36 €	303 10 280 1	1676,36 €		1
315	10	303 00 315 1	2059,96 €	303 10 315 1	2509,96 €		1
355	6	303 00 355 1	☎	303 10 355 1	☎		1
400	6	303 00 400 1	☎	303 10 400 1	☎		1



**Opsiyonlar:** Akülü açma/kapama emniyet kumandalı olabilir. Oransal kontrol ünitesi, potansiyonometre, lokal kontrol ünitesi, pozisyon transмитeri opsiyonları mevcuttur.

**Boru flanş bağlantı ölçüleri:** EN 1092 PN10, ISO 7005 PN10, ANSI B 16,5 class 150, BS 1560 1958

**Aktüatör flanş bağlantı ölçüleri:** ISO 5211/24V DC - 24V AC.

**Options:** Battery powered on/off can be safety controlled. Option control unit, potentiometer, local control unit, position transmitter options are available.

**Pipe flange connection dimensions:** EN 1092 PN10, ISO 7005 PN10, ANSI B 16,5 class 150, BS 1560 1958

**Actuator flange connection measures:** ISO 5211/24V DC - 24V AC.

**U-PVC Elektrik Aktüatörlü Kelebek Vana 100-260 V AC (Takım)**  
*U-PVC Butterfly Valves Electric Actuator 100 -260 V AC (With Flange)*

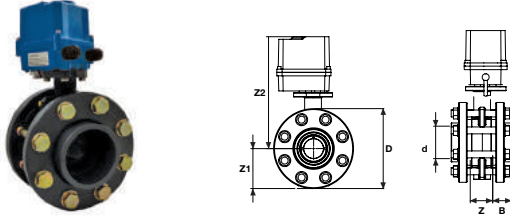

Çap Dia	DN (mm)	D (mm)	Z (mm)	Z1 (mm)	Z2 (mm)	B (mm)	nØe	ISO 5211 ISO 5211
63	50	165	51	83	395	38	4 x 19	F 07
75	65	185	52	93	399	43	4 x 19	F 07
90	80	200	58	100	398	51	8 x 19	F 07
110	100	220	66	110	438	60	8 x 19	F 07
125	110	250	73	125	447	69	8 x 23	F 07
140	125	250	73	125	447	75	8 x 23	F 07
160	150	285	76	143	459	86	8 x 24	F 07
200	175	340	87	170	509	106	8 x 24	F 07
225	200	340	87	170	509	120	8 x 24	F 07
250	250	395	123	198	625	131	8 x 24	F 10
280	250	395	119	198	629	146	12 x 24	F 10
315	300	445	121	228	802	164	12 x 24	F 10
355	350	505	140	255	372	185	16 x 24	F 12
400	400	565	169	285	402	206	16 x 26	F 12

Su İçin / For Water

Asit İçin / For Acid

Çap Dia	Basınç PN	EPDM Conta Kod EPDM O-Ring Code	Fiyat (Adet) Price (Pcs)	FPM Conta Kod FPM O-Ring Code	Fiyat (Adet) Price (Pcs)	Kg /Adet Kg/Pcs	Koli/Ad. Box/Pcs
63	10	305 00 063 4	315,94 €	305 01 063 4	345,94 €	3,10	1
75	10	305 00 075 4	316,64 €	305 01 075 4	349,14 €	3,33	1
90	10	305 00 090 4	428,84 €	305 01 090 4	464,84 €	3,83	1
110	10	305 00 110 4	437,99 €	305 01 110 4	478,49 €	4,32	1
125	10	305 00 125 4	739,48 €	305 01 125 4	786,98 €	6,60	1
140	10	305 00 140 4	739,48 €	305 01 140 4	786,98 €	8,95	1
160	10	305 00 160 4	783,24 €	305 01 160 4	852,74 €	9,18	1
200	10	305 00 200 4	863,08 €	305 01 200 4	960,58 €	12,2	1
225	10	305 00 225 4	867,08 €	305 01 225 4	966,58 €	14,9	1
250	10	305 00 250 4	1656,36 €	305 01 250 4	1908,86 €	28,5	1
280	10	305 00 280 4	1671,36 €	305 01 280 4	1931,36 €	28,5	1
315	10	305 00 315 4	2309,96 €	305 01 315 4	2884,96 €	36,1	1
355	6	305 00 355 4	☎	305 01 355 4	☎		1
400	6	305 00 400 4	☎	305 01 400 4	☎		1

**Opsiyonlar:** Akülü açma/kapama emniyet kumandalı olabilir. Oransal kontrol ünitesi, potansiyometre, lokal kontrol ünitesi, pozisyon transмитeri opsiyonları mevcuttur.

**Boru flanş bağlantı ölçüleri:** EN 1092 PN10, ISO 7005 PN10, ANSI B 16,5 class 150, BS 1560 1958

**Aktüatör flanş bağlantı ölçüleri:** ISO 5211/24V DC - 24V AC.

**Options:** Battery powered on/off can be safety controlled. Option control unit, potentiometer, local control unit, position transmitter options are available.

**Pipe flange connection dimensions:** EN 1092 PN10, ISO 7005 PN10, ANSI B 16,5 class 150, BS 1560 1958

**Actuator flange connection measures:** ISO 5211/24V DC - 24V AC.



## U-PVC Elektrik Aktüatörlü Kelebek Vana 100-260 V AC 304/316 Paslanmaz Civata-Somun-Pul

U-PVC Butterfly Valves Electric Actuator 100 -260 V AC 304/316 Stainless Steel Screw-Nut-Washer (With Flange)

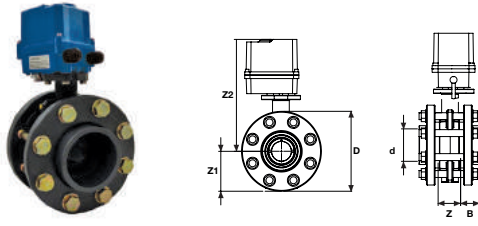

Çap Dia	DN (mm)	D (mm)	Z (mm)	Z1 (mm)	Z2 (mm)	B (mm)	Q1 (mm)	Q2 (mm)	nØe	ISO 5211 ISO 5211	Basınç PN	kv-value l/min.	Kg /Adet Kg/Pcs	Koli/Ad. Box/Pcs
63	50	165	51	82	395	38	37		4 x 19	F 07	10	1470	4,98	1
75	65	185	52	92	399	43	50	40	4 x 19	F 07	10	2200	5,58	1
90	80	200	58	100	398	51	65	46	8 x 19	F 07	10	3000	7,54	1
110	100	220	66	110	438	60	85	68	8 x 19	F 07	10	6500	9,65	1
125	110	250	73	125	447	69	111	92	8 x 23	F 07	10	11500	11,88	1
140	125	250	73	125	447	75	111	92	8 x 23	F 07	10	11500	14,63	1
160	150	285	76	142	459	86	138	122	8 x 24	F 07	10	16600	15,79	1
200	175	340	87	170	509	106	192	179	8 x 24	F 07	10	39600	24,69	1
225	200	340	87	170	509	120	192	179	8 x 24	F 07	10	39600	24,39	1
250	250	395	123	198	625	131	223	209	8 x 24	F 10	10	55200	45,56	1
280	250	395	119	198	629	146	223	209	12 x 24	F 10	10	55200	48,06	1
315	300	445	121	228	802	164	256	253	12 x 24	F 10	10	80000	56,32	1
355	350	505	140	255	372	185	325	305	16 x 24	F 12	6	90000		1
400	400	565	169	285	402	206	353	350	16 x 26	F 12	6	115000		1

### 304 Paslanmaz Civata-Somun-Pul / 304.S.S.Screw,Nut,Washer

Su İçin / For Water

Asit İçin / For Acid

Çap Dia	EPDM Conta Kod EPDM O-Ring Code	Fiyat (Adet) Price (Pcs)	FPM Conta Kod FPM O-Ring Code	Fiyat (Adet) Price (Pcs)
63	307 00 063 4	339,94 €	307 01 063 4	365,14 €
75	307 00 075 4	342,64 €	307 01 075 4	369,94 €
90	307 00 090 4	457,64 €	307 01 090 4	488,24 €
110	307 00 110 4	470,39 €	307 01 110 4	504,41 €
125	307 00 125 4	777,48 €	307 01 125 4	817,38 €
140	307 00 140 4	777,48 €	307 01 140 4	817,38 €
160	307 00 160 4	838,84 €	307 01 160 4	897,22 €
200	307 00 200 4	941,08 €	307 01 200 4	1022,98 €
225	307 00 225 4	946,68 €	307 01 225 4	1030,26 €
250	307 00 250 4	1858,36 €	307 01 250 4	2070,46 €
280	307 00 280 4	1879,36 €	307 01 280 4	2115,96 €
315	307 00 315 4	2769,96 €	307 01 315 4	3252,96 €
355	307 00 355 4	☎	307 01 355 4	☎
400	307 00 400 4	☎	307 01 400 4	☎

### 316 Paslanmaz Civata-Somun-Pul / 316.S.S.Screw,Nut,Washer

Su İçin / For Water

Asit İçin / For Acid

Çap Dia	EPDM Conta Kod EPDM O-Ring Code	Fiyat (Adet) Price (Pcs)	FPM Conta Kod FPM O-Ring Code	Fiyat (Adet) Price (Pcs)
63	309 00 063 4	381,94 €	309 01 063 4	432,34 €
75	309 00 075 4	388,14 €	309 01 075 4	442,74 €
90	309 00 090 4	508,04 €	309 01 090 4	568,52 €
110	309 00 110 4	535,49 €	309 01 110 4	606,89 €
125	309 00 125 4	843,98 €	309 01 125 4	923,78 €
140	309 00 140 4	843,98 €	309 01 140 4	923,78 €
160	309 00 160 4	936,14 €	309 01 160 4	1052,90 €
200	309 00 200 4	1077,58 €	309 01 200 4	1241,38 €
225	309 00 225 4	1085,98 €	309 01 225 4	1253,14 €
250	309 00 250 4	2211,86 €	309 01 250 4	2636,06 €
280	309 00 280 4	2243,36 €	309 01 280 4	2680,16 €
315	309 00 315 4	3574,96 €	309 01 315 4	4540,96 €
355	309 00 355 4	☎	309 01 355 4	☎
400	309 00 400 4	☎	309 01 400 4	☎

**Opsiyonlar:** Akülü açma/kapama emniyet kumandalı olabilir. Oransal kontrol ünitesi, potansiyonometre, lokal kontrol ünitesi, pozisyon transmitteri opsiyonları mevcuttur.

**Boru flanş bağlantı ölçüleri:** EN 1092 PN10, ISO 7005 PN10, ANSI B 16,5 class 150, BS 1560 1958

**Aktüatör flanş bağlantı ölçüleri:** ISO 5211/24V DC - 24V AC.

**Options:** Battery powered on/off can be safety controlled. Option control unit, potentiometer, local control unit, position transmitter options are available.

**Pipe flange connection dimensions:** EN 1092 PN10, ISO 7005 PN10, ANSI B 16,5 class 150, BS 1560 1958

**Actuator flange connection measures:** ISO 5211/24V DC - 24V AC.



**U-PVC Pnömatik Aktüatörlü Kelebek Vana Çift Etkili (Çıplak)**  
*U-PVC Pneumatic Actuator Butterfly Valves Double Effect Without Flange*

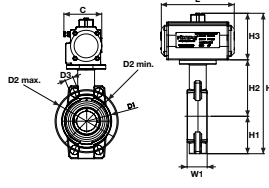

Çap Dia	DN (mm)	D1 (mm)	D2 min. (mm)	D2 max. (mm)	D3 (mm)	H (mm)	H1 (mm)	H2 (mm)	H3 (mm)	C (mm)	W1 (mm)	L (mm)	kv-value l/min.	ISO 5211 ISO 5211
63	50	54	120	125	19	303	77	134	92	72	45	147	1470	F 07
75	65	57	140	145	19	307	86	129	92	72	46	147	2200	F 07
90	80	131	150	160	19	307	89	132	108	83	48	168	3000	F 07
110	100	160	175	190	19	379	103	156	120	95	56	184	6500	F 07
125	110	190	210	216	23	405	116	169	120	95	63	184	11500	F 07
140	125	190	210	216	23	405	116	169	120	100	63	184	11500	F 07
160	150	214	241	241	24	441	129	182	130	100	66	204	16600	F 07
200	175	268	290	295	24	501	158	203	140	108	75	262	39600	F 07
225	200	268	290	295	24	501	158	203	140	108	75	262	39600	F 07
250	250	333	341	362	24	593	198	242	153	122	114	268	55200	F 10
280	250	333	341	362	24	593	198	242	153	122	114	268	55200	F 10
315	300	379	400	432	25	668	228	285	175	142	113	296	80000	F 10
355	350	345	460	-	25	670	345	410	260	226	88	525	90000	F 12
400													115000	F 12

*Su İçin / For Water*

*Asit İçin / For Acid*

Çap Dia	Basınç PN	EPDM Conta Kod EPDM O-Ring Code	Fiyat (Adet) Price (Pcs)	FPM Conta Kod FPM O-Ring Code	Fiyat (Adet) Price (Pcs)	Kg /Adet Kg/Pcs	Koli/Ad. Box/Pcs
63	10	318 00 063 4	171,48 €	318 01 063 4	191,98 €	2,25	1
75	10	318 00 075 4	171,48 €	318 01 075 4	193,98 €	2,48	1
90	10	318 00 090 4	175,37 €	318 01 090 4	199,37 €	3,71	1
110	10	318 00 110 4	196,94 €	318 01 110 4	224,44 €	4,20	1
125	10	318 00 125 4	205,01 €	318 01 125 4	236,01 €	7,15	1
140	10	318 00 140 4	205,01 €	318 01 140 4	236,01 €	8,00	1
160	10	318 00 160 4	236,08 €	318 01 160 4	275,58 €	9,98	1
200	10	318 00 200 4	305,06 €	318 01 200 4	371,06 €	13,7	1
225	10	318 00 225 4	305,06 €	318 01 225 4	371,06 €	13,7	1
250	10	318 00 250 4	578,65 €	318 01 250 4	1103,65 €	30,5	1
280	10	318 00 280 4	578,65 €	318 01 280 4	1103,65 €	30,5	1
315	10	318 00 315 4	1182,09 €	318 01 315 4	2532,09 €	38,1	1
355	6	318 00 355 4	☎	318 01 355 4	☎		1
400	6	318 00 400 4	☎	318 01 400 4	☎		1

**Opsiyonlar:** Kolay montaj/demontaj imkanı, pozisyoner, limit anahtar kutusu, namur solenoid vana, el kontrol ünitesi.  
**Aktüatör flanş bağlantı ölçüleri:** ISO 5211.  
 İhtiyaca göre opsiyon ilave edilebilir.

**Options:** Easy assembly/disassembly, potentiometer, limit switch box, namur solenoid valve, hand control unit.  
**Actuator flange connection dimensions:** ISO 5211  
 Options could be add according to the needs.

## U-PVC Pnömatik Aktüatörlü Kelebek Vana Çift Etkili (Takım)

### U-PVC Pneumatic Actuator Butterfly Valves Double Effect With Flange

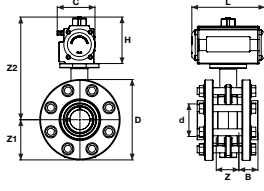

Çap Dia	DN (mm)	C (mm)	D (mm)	Z (mm)	Z1 (mm)	B (mm)	L (mm)	H (mm)	nØe (mm)	kv-value l/min.	ISO 5211 ISO 5211
63	50	72	165	51	82	38	147	90	4 x 19	1470	F 07
75	65	72	185	52	92	43	147	90	4 x 19	2200	F 07
90	80	63	200	58	100	51	168	108	8 x 19	3000	F 07
110	100	95	220	66	110	60	184	120	8 x 19	6500	F 07
125	110	95	250	73	125	69	184	120	8 x 23	11500	F 07
140	125	100	250	73	125	75	184	120	8 x 23	11500	F 07
160	150	100	285	76	142	86	204	130	8 x 24	16600	F 07
200	175	108	340	87	170	106	262	140	8 x 24	39600	F 07
225	200	108	340	87	170	120	262	140	8 x 24	39600	F 07
250	250	122	395	123	198	131	268	153	8 x 24	55200	F 10
280	250	122	395	119	198	146	268	153	12 x 24	55200	F 10
315	300	142	445	121	228	164	296	175	12 x 24	80000	F 10
355										90000	
400										115000	

## Su İçin / For Water

## Asit İçin / For Acid

Çap Dia	Basınç PN	EPDM Conta Kod EPDM O-Ring Code	Fiyat (Adet) Price (Pcs)	FPM Conta Kod FPM O-Ring Code	Fiyat (Adet) Price (Pcs)	Kg /Adet Kg/Pcs	Koli/Ad. Box/Pcs
63	10	319 00 063 4	190,48 €	319 01 063 4	220,48 €	4,13	1
75	10	319 00 075 4	191,48 €	319 01 075 4	223,98 €	4,73	1
90	10	319 00 090 4	199,37 €	319 01 090 4	235,37 €	7,42	1
110	10	319 00 110 4	226,94 €	319 01 110 4	263,44 €	9,53	1
125	10	319 00 125 4	238,01 €	319 01 125 4	285,51 €	12,43	1
140	10	319 00 140 4	238,01 €	319 01 140 4	285,51 €	13,68	1
160	10	319 00 160 4	296,08 €	319 01 160 4	365,58 €	16,59	1
200	10	319 00 200 4	368,06 €	319 01 200 4	465,56 €	23,19	1
225	10	319 00 225 4	372,06 €	319 01 225 4	471,56 €	23,19	1
250	10	319 00 250 4	733,65 €	319 01 250 4	986,15 €	47,56	1
280	10	319 00 280 4	748,65 €	319 01 280 4	1008,65 €	50,06	1
315	10	319 00 315 4	1432,09 €	319 01 315 4	2007,90 €	58,32	1
355	6	319 00 355 4	☎	319 01 355 4	☎		1
400	6	319 00 400 4	☎	319 01 400 4	☎		1

**Opsiyonlar:** Kolay montaj/demontaj imkanı, pozisyoner, limit anahtar kutusu, namur solenoid vana, el kontrol ünitesi.  
**Aktüatör flanş bağlantı ölçüleri:** ISO 5211.  
 İhtiyaca göre opsiyon ilave edilebilir.

**Options:** Easy assembly/disassembly, potentiometer, limit switch box, namur solenoid valve, hand control unit.  
**Actuator flange connection dimensions:** ISO 5211  
 Options could be add according to the needs.



**U-PVC Pnömatik Aktüatörlü Kelebek Vana Çift Etkili 304/316 Paslanmaz Civata-Somun-Pul**  
*U-PVC Pneumatic Actuator Butterfly Valves Double Effect 304/316 S.S. Screw, Nut, Washer*

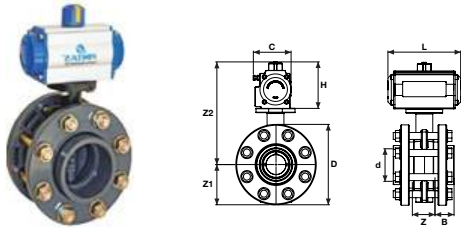

Çap Dia	DN (mm)	C (mm)	D (mm)	Z (mm)	Z1 (mm)	B (mm)	L (mm)	H (mm)	Q1 (mm)	Q2 (mm)	nØe (mm)	ISO 5211 ISO 5211	Basınç PN	kv-value l/min.	Kg /Adet Kg/Pcs	Koli/Ad. Box/Pcs
63	50	72	165	51	82	38	147	90	37		4 x 19	F 07	10	1470	4,13	1
75	65	72	185	52	92	43	147	90	50	40	4 x 19	F 07	10	2200	4,73	1
90	80	63	200	58	100	51	168	108	65	46	8 x 19	F 07	10	3000	7,42	1
110	100	95	220	66	110	60	184	120	85	68	8 x 19	F 07	10	6500	9,53	1
125	110	95	250	73	125	69	184	120	111	92	8 x 23	F 07	10	11500	12,43	1
140	125	100	250	73	125	75	184	120	111	92	8 x 23	F 07	10	11500	13,68	1
160	150	100	285	76	142	86	204	130	138	122	8 x 24	F 07	10	16600	16,59	1
200	175	108	340	87	170	106	262	140	192	179	8 x 24	F 07	10	39600	23,19	1
225	200	108	340	87	170	120	262	140	192	179	8 x 24	F 07	10	39600	23,19	1
250	250	122	395	123	198	131	268	153	223	209	8 x 24	F 10	10	55200	47,56	1
280	250	122	395	119	198	146	268	153	223	209	12 x 24	F 10	10	55200	50,06	1
315	300	142	445	121	228	164	296	175	256	253	12 x 24	F 10	10	80000	58,32	1
355									325	305			6	90000		1
400									353	350			6	115000		1

**304 Paslanmaz Civata-Somun-Pul / 304.S.S.Screw,Nut,Washer**

Su İçin / For Water

Asit İçin / For Acid

Çap Dia	EPDM Conta Kod EPDM O-Ring Code	Fiyat (Adet) Price (Pcs)	FPM Conta Kod FPM O-Ring Code	Fiyat (Adet) Price (Pcs)
63	320 00 063 4	214,48 €	320 01 063 4	239,68 €
75	320 00 075 4	217,48 €	320 01 075 4	244,78 €
90	320 00 090 4	228,17 €	320 01 090 4	258,41 €
110	320 00 110 4	255,34 €	320 01 110 4	296,64 €
125	320 00 125 4	276,01 €	320 01 125 4	315,91 €
140	320 00 140 4	276,01 €	320 01 140 4	315,91 €
160	320 00 160 4	351,68 €	320 01 160 4	410,06 €
200	320 00 200 4	446,06 €	320 01 200 4	527,96 €
225	320 00 225 4	451,66 €	320 01 225 4	535,24 €
250	320 00 250 4	935,65 €	320 01 250 4	1147,75 €
280	320 00 280 4	956,65 €	320 01 280 4	1193,25 €
315	320 00 315 4	1892,09 €	320 01 315 4	2375,09 €
355	320 00 355 4	☞	320 01 355 4	☞
400	320 00 400 4	☞	320 01 400 4	☞

**316 Paslanmaz Civata-Somun-Pul / 316.S.S.Screw,Nut,Washer**

Su İçin / For Water

Asit İçin / For Acid

Çap Dia	EPDM Conta Kod EPDM O-Ring Code	Fiyat (Adet) Price (Pcs)	FPM Conta Kod FPM O-Ring Code	Fiyat (Adet) Price (Pcs)
63	321 00 063 4	256,48 €	321 01 063 4	306,88 €
75	321 00 075 4	262,98 €	321 01 075 4	317,58 €
90	321 00 090 4	278,57 €	321 01 090 4	339,05 €
110	321 00 110 4	320,44 €	321 01 110 4	391,84 €
125	321 00 125 4	342,51 €	321 01 125 4	422,31 €
140	321 00 140 4	342,51 €	321 01 140 4	422,31 €
160	321 00 160 4	448,98 €	321 01 160 4	565,74 €
200	321 00 200 4	582,56 €	321 01 200 4	746,36 €
225	321 00 225 4	590,96 €	321 01 225 4	758,12 €
250	321 00 250 4	1289,15 €	321 01 250 4	1713,35 €
280	321 00 280 4	1320,65 €	321 01 280 4	1757,45 €
315	321 00 315 4	2697,09 €	321 01 315 4	3663,09 €
355	321 00 355 4	☞	321 01 355 4	☞
400	321 00 400 4	☞	321 01 400 4	☞

**Opsiyonlar:** Kolay montaj/demontaj imkanı, pozisyoner, limit anahtar kutusu, namur solenoid vana, el kontrol ünitesi.  
**Aktüatör flanş bağlantı ölçüleri:** ISO 5211.  
 İhtiyaca göre opsiyon ilave edilebilir.

**Options:** Easy assembly/disassembly, potentiometer, limit switch box, namur selenoid valve, hand control unit.  
**Actuator flange connection dimensions:** ISO 5211  
 Options could be add according to the needs.

## U-PVC Pnömatik Aktüatörlü Kelebek Vana Tek Etkili Çıplak

### U-PVC Pneumatic Actuator Butterfly Valves Single Effect Without Flange

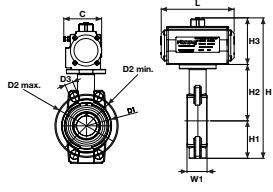

Çap Dia	DN (mm)	D1 (mm)	D2 min. (mm)	D2 max. (mm)	D3 (mm)	H (mm)	H1 (mm)	H2 (mm)	H3 (mm)	C (mm)	W1 (mm)	L (mm)	kv-value l/min.	ISO 5211 ISO 5211
63	50	54	120	125	19	303	77	134	92	72	45	147	1470	F 07
75	65	57	140	145	19	307	86	129	92	72	46	147	2200	F 07
90	80	131	150	160	19	307	89	132	108	83	48	168	3000	F 07
110	100	160	175	190	19	379	103	156	120	95	56	184	6500	F 07
125	110	190	210	216	23	405	116	169	120	95	63	184	11500	F 07
140	125	190	210	216	23	405	116	169	120	100	63	184	11500	F 07
160	150	214	241	241	24	441	129	182	130	100	66	204	16600	F 07
200	175	268	290	295	24	501	158	203	140	108	75	262	39600	F 07
225	200	268	290	295	24	501	158	203	140	108	75	262	39600	F 07
250	250	333	341	362	24	593	198	242	153	122	114	268	55200	F 10
280	250	333	341	362	24	593	198	242	153	122	114	268	55200	F 10
315	300	379	400	432	25	668	228	285	175	142	113	296	80000	F 10
355													90000	
400													115000	

## Su İçin / For Water

## Asit İçin / For Acid

Çap Dia	Basınç PN	EPDM Conta Kod EPDM O-Ring Code	Fiyat (Adet) Price (Pcs)	FPM Conta Kod FPM O-Ring Code	Fiyat (Adet) Price (Pcs)	Kg /Adet Kg/Pcs	Koli/Ad. Box/Pcs
63	10	310 00 063 4	301,96 €	310 01 063 4	322,46 €	2,25	1
75	10	310 00 075 4	301,96 €	310 01 075 4	322,46 €	2,48	1
90	10	310 00 090 4	302,74 €	310 01 090 4	326,74 €	3,71	1
110	10	310 00 110 4	338,88 €	310 01 110 4	366,38 €	4,20	1
125	10	310 00 125 4	348,02 €	310 01 125 4	379,02 €	7,15	1
140	10	310 00 140 4	348,02 €	310 01 140 4	379,02 €	8,00	1
160	10	310 00 160 4	550,24 €	310 01 160 4	589,74 €	9,98	1
200	10	310 00 200 4	651,18 €	310 01 200 4	717,18 €	13,7	1
225	10	310 00 225 4	651,18 €	310 01 225 4	717,18 €	13,7	1
250	10	310 00 250 4	1035,95 €	310 01 250 4	1210,95 €	30,5	1
280	10	310 00 280 4	1035,95 €	310 01 280 4	1210,95 €	30,5	1
315	10	310 00 315 4	1746,27 €	310 01 315 4	2196,27 €	38,1	1
355	6	310 00 355 4	☎	310 01 355 4	☎		1
400	6	310 00 400 4	☎	310 01 400 4	☎		1

**Opsiyonlar:** Kolay montaj/demontaj imkanı, pozisyoner, limit anahtar kutusu, namur solenoid vana, el kontrol ünitesi.  
**Aktüatör flanş bağlantı ölçüleri:** ISO 5211.  
 İhtiyaca göre opsiyon ilave edilebilir.

**Options:** Easy assembly/disassembly, potentiometer, limit switch box, namur solenoid valve, hand control unit.  
**Actuator flange connection dimensions:** ISO 5211  
 Options could be add according to the needs.



**U-PVC Pnömatik Aktüatörlü Kelebek Vana Tek Etkili Takım**

*U-PVC Pneumatic Actuator Butterfly Valves Single Effect Without Flange*

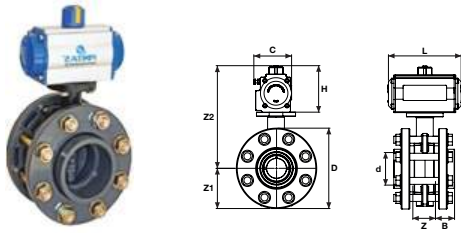

Çap Dia	DN (mm)	C (mm)	D (mm)	Z (mm)	Z1 (mm)	B (mm)	L (mm)	H (mm)	nØe (mm)	kv-value l/min.	ISO 5211 ISO 5211
63	50	72	165	51	82	38	147	90	4 x 19	1470	F 07
75	65	72	185	52	92	43	147	90	4 x 19	2200	F 07
90	80	63	200	58	100	51	168	108	8 x 19	3000	F 07
110	100	95	220	66	110	60	184	120	8 x 19	6500	F 07
125	110	95	250	73	125	69	184	120	8 x 23	11500	F 07
140	125	100	250	73	125	75	184	120	8 x 23	11500	F 07
160	150	100	285	76	142	86	204	130	8 x 24	16600	F 07
200	175	108	340	87	170	106	262	140	8 x 24	39600	F 07
225	200	108	340	87	170	120	262	140	8 x 24	39600	F 07
250	250	122	395	123	198	131	268	153	8 x 24	55200	F 10
280	250	122	395	119	198	146	268	153	12 x 24	55200	F 10
315	300	142	445	121	228	164	296	175	12 x 24	80000	F 10
355										90000	
400										115000	

Su İçin / For Water

Asit İçin / For Acid

Çap Dia	Basınç PN	EPDM Conta Kod EPDM O-Ring Code	Fiyat (Adet) Price (Pcs)	FPM Conta Kod FPM O-Ring Code	Fiyat (Adet) Price (Pcs)	Kg /Adet Kg/Pcs	Koli/Ad. Box/Pcs
63	10	312 00 063 4	320,96 €	312 01 063 4	350,96 €	4,13	1
75	10	312 00 075 4	322,00 €	312 01 075 4	351,46 €	4,73	1
90	10	312 00 090 4	326,74 €	312 01 090 4	362,74 €	7,42	1
110	10	312 00 110 4	364,88 €	312 01 110 4	405,38 €	9,53	1
125	10	312 00 125 4	381,02 €	312 01 125 4	428,52 €	12,43	1
140	10	312 00 140 4	381,02 €	312 01 140 4	428,52 €	13,68	1
160	10	312 00 160 4	610,24 €	312 01 160 4	679,74 €	16,59	1
200	10	312 00 200 4	714,18 €	312 01 200 4	811,68 €	23,19	1
225	10	312 00 225 4	718,18 €	312 01 225 4	817,68 €	23,19	1
250	10	312 00 250 4	1.190,95 €	312 01 250 4	1.443,45 €	47,56	1
280	10	312 00 280 4	1.205,95 €	312 01 280 4	1.465,95 €	50,06	1
315	10	312 00 315 4	1.996,27 €	312 01 315 4	2.571,27 €	58,32	1
355	6	312 00 355 4	☎	312 01 355 4	☎		1
400	6	312 00 400 4	☎	312 01 400 4	☎		1

**Opsiyonlar:** Kolay montaj/demontaj imkanı, pozisyoner, limit anahtar kutusu, namur solenoid vana, el kontrol ünitesi.  
**Aktüatör flanş bağlantı ölçüleri:** ISO 5211.  
 İhtiyaca göre opsiyon ilave edilebilir.

**Options:** Easy assembly/disassembly, potentiometer, limit switch box, namur solenoid valve, hand control unit.  
**Actuator flange connection dimensions:** ISO 5211  
 Options could be add according to the needs.

## U-PVC Pnömatik Aktüatörlü Kelebek Vana Tek Etkili 304/316 Paslanmaz Civata-Somun-Pul

### U-PVC Pneumatic Actuator Butterfly Valves Double Effect 304/316 S.S. Screw, Nut, Washer

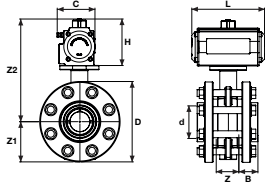

Çap Dia	DN (mm)	C (mm)	D (mm)	Z (mm)	Z1 (mm)	B (mm)	L (mm)	H (mm)	nØe (mm)	ISO 5211	Basınç PN	kv-value l/min.	Q1 (mm)	Q2 (mm)	Kg /Adet Kg/Pcs	Koli/Ad. Box/Pcs
63	50	72	165	51	82	38	147	90	4 x 19	F 07	10	1470	37		4,13	1
75	65	72	185	52	92	43	147	90	4 x 19	F 07	10	2200	50	40	4,73	1
90	80	63	200	58	100	51	168	108	8 x 19	F 07	10	3000	65	46	7,42	1
110	100	95	220	66	110	60	184	120	8 x 19	F 07	10	6500	85	68	9,53	1
125	110	95	250	73	125	69	184	120	8 x 23	F 07	10	11500	111	92	12,43	1
140	125	100	250	73	125	75	184	120	8 x 23	F 07	10	11500	111	92	13,68	1
160	150	100	285	76	142	86	204	130	8 x 24	F 07	10	16600	138	122	16,59	1
200	175	108	340	87	170	106	262	140	8 x 24	F 07	10	39600	192	179	23,19	1
225	200	108	340	87	170	120	262	140	8 x 24	F 07	10	39600	192	179	23,19	1
250	250	122	395	123	198	131	268	153	8 x 24	F 10	10	55200	223	209	47,56	1
280	250	122	395	119	198	146	268	153	12 x 24	F 10	10	55200	223	209	50,06	1
315	300	142	445	121	228	164	296	175	12 x 24	F 10	10	80000	256	253	58,32	1
355											6	90000	325	305		1
400											6	115000	353	350		1

#### 304 Paslanmaz Civata-Somun-Pul / 304.S.S.Screw,Nut,Washer

#### 316 Paslanmaz Civata-Somun-Pul / 316.S.S.Screw,Nut,Washer

Su İçin / For Water

Asit İçin / For Acid

Su İçin / For Water

Asit İçin / For Acid

Çap Dia	EPDM Conta Kod EPDM O-Ring Code	Fiyat (Adet) Price (Pcs)	FPM Conta Kod FPM O-Ring Code	Fiyat (Adet) Price (Pcs)
63	314 00 063 4	344,96 €	314 01 063 4	370,16 €
75	314 00 075 4	345,01 €	314 01 075 4	371,26 €
90	314 00 090 4	355,54 €	314 01 090 4	385,78 €
110	314 00 110 4	397,28 €	314 01 110 4	438,58 €
125	314 00 125 4	419,02 €	314 01 125 4	458,92 €
140	314 00 140 4	419,02 €	314 01 140 4	458,92 €
160	314 00 160 4	668,84 €	314 01 160 4	724,22 €
200	314 00 200 4	792,18 €	314 01 200 4	874,08 €
225	314 00 225 4	797,78 €	314 01 225 4	881,36 €
250	314 00 250 4	1.392,95 €	314 01 250 4	1.605,05 €
280	314 00 280 4	1.413,95 €	314 01 280 4	1.650,55 €
315	314 00 315 4	2.456,27 €	314 01 315 4	2.939,27 €
355	314 00 355 4	☎	314 01 355 4	☎
400	314 00 400 4	☎	314 01 400 4	☎

Çap Dia	EPDM Conta Kod EPDM O-Ring Code	Fiyat (Adet) Price (Pcs)	FPM Conta Kod FPM O-Ring Code	Fiyat (Adet) Price (Pcs)
63	316 00 063 4	386,96 €	316 01 063 4	437,36 €
75	316 00 075 4	389,46 €	316 01 075 4	444,06 €
90	316 00 090 4	405,94 €	316 01 090 4	466,42 €
110	316 00 110 4	462,38 €	316 01 110 4	533,78 €
125	316 00 125 4	485,52 €	316 01 125 4	565,32 €
140	316 00 140 4	485,52 €	316 01 140 4	565,32 €
160	316 00 160 4	763,14 €	316 01 160 4	879,90 €
200	316 00 200 4	928,68 €	316 01 200 4	1.092,48 €
225	316 00 225 4	937,08 €	316 01 225 4	1.104,24 €
250	316 00 250 4	1.746,45 €	316 01 250 4	2.170,65 €
280	316 00 280 4	1.777,95 €	316 01 280 4	2.214,75 €
315	316 00 315 4	3.261,27 €	316 01 315 4	4.227,27 €
355	316 00 355 4	☎	316 01 355 4	☎
400	316 00 400 4	☎	316 01 400 4	☎

**Opsiyonlar:** Kolay montaj/demontaj imkanı, pozisyoner, limit anahtar kutusu, namur solenoid vana, el kontrol ünitesi.  
**Aktüatör flanş bağlantı ölçüleri:** ISO 5211.  
 İhtiyaca göre opsiyon ilave edilebilir.

**Options:** Easy assembly/disassembly, potentiometer, limit switch box, namur solenoid valve, hand control unit.  
**Actuator flange connection dimensions:** ISO 5211  
 Options could be add according to the needs.



### Limit Switch Kutusu Limit Switch Box



Kod Code	Koli/Adet Box/Pcs	Fiyat (Adet) Price (Pcs)
201 19 063 9	1	☎

Gövde / Body : Alüminyum / Aluminium  
Koruma / Protection Class : IP67

### Namur Valf (Yön Valf) Solenoid Valve



Mo	Kod Code	Koli/Adet Box/Pcs	Fiyat (Adet) Price (Pcs)
220VAC 1/4" 5-2	201 18 063 9	1	☎
24VDC 1/4" 5-2	201 18 163 9	1	☎
12VDC-AC 1/4"5-2	201 18 263 9	1	☎

Gövde / Body : Alüminyum / Aluminium  
Koruma / Protection Class : IP67  
Pozisyon / Positions : 3/2-5/2  
Model : Tek ve Çift Bobinli /Single Coil and Double Coils

### Rotary Elektro Pnömatik Pozisyoner Rotary Elektro Pneumatic Positioner



Kod Code	Koli/Adet Box/Pcs	Fiyat (Adet) Price (Pcs)
201 21 063 9	1	☎





**PP**

**VANA, ÇEKVALF, RAKOR, BORU ve EK PARÇA**

VALVE, CHECKVALVE, UNION, PIPE and FITTING

ÜRETİM STANDARDI / PRODUCTION STANDARD

EN 12201-3 2011 / EN 1555-3 2010

ÇAP / SIZE Ø20 - Ø400



**PP Küresel Vana**  
PP True Union Ball Valve

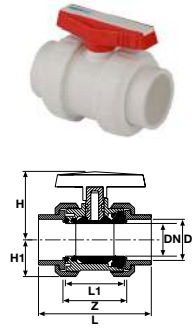

Çap Dia	Basınç PN	Kg/Adet Kg/Pcs	Koli/Adet Box/Pcs	DN (mm)	kv l/min	Z (mm)	L1 (mm)	L (mm)	H (mm)	H1 (mm)
20	10	0,14	55	15	185	52	45	85	47	27
25	10	0,18	75	20	350	58	49	95	51	31
32	10	0,25	60	25	700	61	54	107	63	33
40	10	0,43	30	32	1000	73	66	128	67	41
50	10	0,65	20	40	1600	82	75	154	86	46
63	10	1,13	12	50	3100	95	89	172	101	58
75	10	1,47	9	65	5000	118	111	196	110	73
90	10	3,58	4	80	7000	139	126	241	137	89
110	10	5,43	2	100	11000	165	153	289	150	105

● beyaz

● bej

● yeşil

● mavi

Çap Dia	EPDM Conta Kod EPDM O-Ring Code	Fiyat (Adet) Price (Pcs)	EPDM Conta Kod EPDM O-Ring Code	Fiyat (Adet) Price (Pcs)	EPDM Conta Kod EPDM O-Ring Code	Fiyat (Adet) Price (Pcs)	EPDM Conta Kod EPDM O-Ring Code	Fiyat (Adet) Price (Pcs)
20	400 00 020 2	7,80 €	400 20 020 2	7,80 €	400 40 020 2	7,80 €	400 60 020 2	7,80 €
25	400 00 025 2	9,95 €	400 20 025 2	9,95 €	400 40 025 2	9,95 €	400 60 025 2	9,95 €
32	400 00 032 2	13,00 €	400 20 032 2	13,00 €	400 40 032 2	13,00 €	400 60 032 2	13,00 €
40	400 00 040 2	16,75 €	400 20 040 2	16,75 €	400 40 040 2	16,75 €	400 60 040 2	16,75 €
50	400 00 050 2	18,95 €	400 20 050 2	18,95 €	400 40 050 2	18,95 €	400 60 050 2	18,95 €
63	400 00 063 2	24,50 €	400 20 063 2	24,50 €	400 40 063 2	24,50 €	400 60 063 2	24,50 €
75	400 00 075 2	55,00 €	400 20 075 2	55,00 €	400 40 075 2	55,00 €	400 60 075 2	55,00 €
90	400 00 090 2	70,00 €	400 20 090 2	70,00 €	400 40 090 2	70,00 €	400 60 090 2	70,00 €
110	400 00 110 2	90,00 €	400 20 110 2	90,00 €	400 40 110 2	90,00 €	400 60 110 2	90,00 €

● ● ● ● Beyaz ürün harici diğer renklerde minimum adet için lütfen sorunuz.

**PP Tek Taraf İçten Dişli Küresel Vana**  
PP One Side Female Threaded Ball Valve

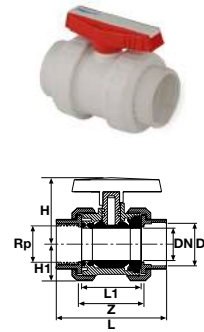

Çap Dia	Rp (Inch)	Basınç PN	Kg/Adet Kg/Pcs	Koli/Adet Box/Pcs	DN (mm)	kv l/min	Z (mm)	L1 (mm)	L (mm)	H (mm)	H1 (mm)
20	1/2"	10	0,14	55	15	185	52	45	85	47	27
25	3/4"	10	0,19	75	20	350	58	49	95	51	31
32	1"	10	0,24	60	25	700	61	54	107	63	33
40	1 1/4"	10	0,42	30	32	1000	73	66	128	67	41
50	1 1/2"	10	0,66	20	40	1600	82	75	154	86	46
63	2"	10	1,17	12	50	3100	95	89	172	101	58
75	2 1/2"	10	1,48	9	65	5000	118	111	196	110	73
90	3"	10	3,56	4	80	7000	139	126	241	137	89
110	4"	10	5,35	2	100	11000	165	153	289	150	105

● beyaz

● bej

● yeşil

● mavi

Çap Dia	Rp (Inch)	EPDM Conta Kod EPDM O-Ring Code	Fiyat (Adet) Price (Pcs)	EPDM Conta Kod EPDM O-Ring Code	Fiyat (Adet) Price (Pcs)	EPDM Conta Kod EPDM O-Ring Code	Fiyat (Adet) Price (Pcs)	EPDM Conta Kod EPDM O-Ring Code	Fiyat (Adet) Price (Pcs)
20	1/2"	401 00 020 2	8,60 €	401 20 020 2	8,60 €	401 40 020 2	8,60 €	401 60 020 2	8,60 €
25	3/4"	401 00 025 2	10,60 €	401 20 025 2	10,60 €	401 40 025 2	10,60 €	401 60 025 2	10,60 €
32	1"	401 00 032 2	14,00 €	401 20 032 2	14,00 €	401 40 032 2	14,00 €	401 60 032 2	14,00 €
40	1 1/4"	401 00 040 2	17,75 €	401 20 040 2	17,75 €	401 40 040 2	17,75 €	401 60 040 2	17,75 €
50	1 1/2"	401 00 050 2	20,15 €	401 20 050 2	20,15 €	401 40 050 2	20,15 €	401 60 050 2	20,15 €
63	2"	401 00 063 2	25,95 €	401 20 063 2	25,95 €	401 40 063 2	25,95 €	401 60 063 2	25,95 €
75	2 1/2"	401 00 075 2	57,00 €	401 20 075 2	57,00 €	401 40 075 2	57,00 €	401 60 075 2	57,00 €
90	3"	401 00 090 2	72,00 €	401 20 090 2	72,00 €	401 40 090 2	72,00 €	401 60 090 2	72,00 €
110	4"	401 00 110 2	93,00 €	401 20 110 2	93,00 €	401 40 110 2	93,00 €	401 60 110 2	93,00 €

● ● ● ● Beyaz ürün harici diğer renklerde minimum adet için lütfen sorunuz.

## PP Çift Taraf İçten Dişli Küresel Vana

### PP Both Side Female Threaded Ball Valve

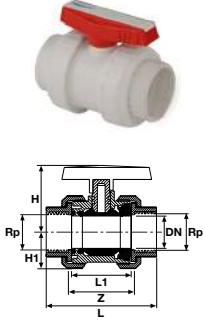

Çap Dia	Rp (Inch)	Basınç PN	Kg/Adet Kg/Pcs	Koli/Adet Box/Pcs	DN (mm)	kv l/min	Z (mm)	L1 (mm)	L (mm)	H (mm)	H1 (mm)
20	1/2"	10	0,14	55	15	185	52	45	85	47	27
25	3/4"	10	0,19	75	20	350	58	49	95	51	31
32	1"	10	0,24	60	25	700	61	54	107	63	33
40	1 1/4"	10	0,42	30	32	1000	73	66	128	67	41
50	1 1/2"	10	0,66	20	40	1600	82	75	154	86	46
63	2"	10	1,17	12	50	3100	95	89	172	101	58
75	2 1/2"	10	1,48	9	65	5000	118	111	196	110	73
90	3"	10	3,56	4	80	7000	139	126	241	137	89
110	4"	10	5,35	2	100	11000	165	153	289	150	105

● beyaz

● bej

● yeşil

● mavi

Rp (Inch)	EPDM Conta Kod EPDM O-Ring Code	Fiyat (Adet) Price (Pcs)	EPDM Conta Kod EPDM O-Ring Code	Fiyat (Adet) Price (Pcs)	EPDM Conta Kod EPDM O-Ring Code	Fiyat (Adet) Price (Pcs)	EPDM Conta Kod EPDM O-Ring Code	Fiyat (Adet) Price (Pcs)
1/2"	402 00 020 2	9,20 €	402 20 020 2	9,20 €	402 40 020 2	9,20 €	402 60 020 2	9,20 €
3/4"	402 00 025 2	11,20 €	402 20 025 2	11,20 €	402 40 025 2	11,20 €	402 60 025 2	11,20 €
1"	402 00 032 2	15,00 €	402 20 032 2	15,00 €	402 40 032 2	15,00 €	402 60 032 2	15,00 €
1 1/4"	402 00 040 2	18,75 €	402 20 040 2	18,75 €	402 40 040 2	18,75 €	402 60 040 2	18,75 €
1 1/2"	402 00 050 2	21,15 €	402 20 050 2	21,15 €	402 40 050 2	21,15 €	402 60 050 2	21,15 €
2"	402 00 063 2	27,15 €	402 20 063 2	27,15 €	402 40 063 2	27,15 €	402 60 063 2	27,15 €
2 1/2"	402 00 075 2	58,50 €	402 20 075 2	58,50 €	402 40 075 2	58,50 €	402 60 075 2	58,50 €
3"	402 00 090 2	73,50 €	402 20 090 2	73,50 €	402 40 090 2	73,50 €	402 60 090 2	73,50 €
4"	402 00 110 2	95,00 €	402 20 110 2	95,00 €	402 40 110 2	95,00 €	402 60 110 2	95,00 €

● ● ● ● Beyaz ürün harici diğer renklerde minimum adet için lütfen sorunuz.

## PP Çift Taraf Flanş Bağlantılı Küresel Vana

### PP Both Side Flanged Ball Valve

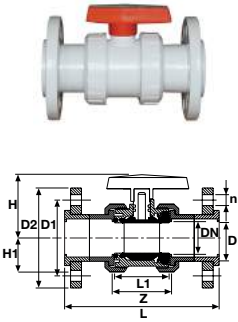

Çap Dia	Basınç PN	Kg/Adet Kg/Pcs	Koli/Adet Box/Pcs	DN (mm)	kv l/min	Z (mm)	L1 (mm)	L (mm)	H (mm)	H1 (mm)	D1 (mm)	D2 (mm)	n (mmxAdet)
20	10	0,36	40	15	185	52	45	123	47	27	65	95	14 x 4
25	10	0,47	30	20	350	58	49	140	51	31	75	105	14 x 4
32	10	0,66	25	25	700	61	54	158	63	33	85	115	14 x 4
40	10	1,08	20	32	1000	73	66	186	67	42	100	140	18 x 4
50	10	1,44	10	40	1600	82	75	231	86	46	110	150	18 x 4
63	10	2,29	10	50	3100	95	89	253	101	58	125	165	18 x 4
75	10	2,99	4	65	5000	118	111	291	110	73	145	185	18 x 4
90	10	5,7	2	80	7000	139	126	353	137	90	160	200	18 x 8
110	10	8,05	1	100	11000	165	153	431	150	106	180	220	18 x 8

● beyaz

● bej

● yeşil

● mavi

Çap Dia	EPDM Conta Kod EPDM O-Ring Code	Fiyat (Adet) Price (Pcs)	EPDM Conta Kod EPDM O-Ring Code	Fiyat (Adet) Price (Pcs)	EPDM Conta Kod EPDM O-Ring Code	Fiyat (Adet) Price (Pcs)	EPDM Conta Kod EPDM O-Ring Code	Fiyat (Adet) Price (Pcs)
20	403 00 020 2	21,50 €	403 20 020 2	21,50 €	403 40 020 2	21,50 €	403 60 020 2	21,50 €
25	403 00 025 2	24,50 €	403 20 025 2	24,50 €	403 40 025 2	24,50 €	403 60 025 2	24,50 €
32	403 00 032 2	29,50 €	403 20 032 2	29,50 €	403 40 032 2	29,50 €	403 60 032 2	29,50 €
40	403 00 040 2	35,40 €	403 20 040 2	35,40 €	403 40 040 2	35,40 €	403 60 040 2	35,40 €
50	403 00 050 2	39,75 €	403 20 050 2	39,75 €	403 40 050 2	39,75 €	403 60 050 2	39,75 €
63	403 00 063 2	44,95 €	403 20 063 2	44,95 €	403 40 063 2	44,95 €	403 60 063 2	44,95 €
75	403 00 075 2	87,85 €	403 20 075 2	87,85 €	403 40 075 2	87,85 €	403 60 075 2	87,85 €
90	403 00 090 2	110,00 €	403 20 090 2	110,00 €	403 40 090 2	110,00 €	403 60 090 2	110,00 €
110	403 00 110 2	175,00 €	403 20 110 2	175,00 €	403 40 110 2	175,00 €	403 60 110 2	175,00 €

● ● ● ● Beyaz ürün harici diğer renklerde minimum adet için lütfen sorunuz.



**PP Tek Taraf Piriç İçten Dişli Küresel Vana**  
PP One Side Brass Female Threaded Ball Valve

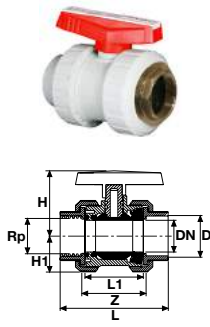

Çap Dia	Rp (Inch)	Basınç PN	Kg/Adet Kg/Pcs	Koli/Adet Box/Pcs	DN (mm)	kv l/min	Z (mm)	L1 (mm)	L (mm)	H (mm)	H1 (mm)
20	1/2"	10	0,18	55	15	185	52	45	86	47	27
25	3/4"	10	0,24	75	20	350	58	49	96	51	31
32	1"	10	0,31	60	25	700	61	54	106	63	33
40	1 1/4"	10	0,50	30	32	1000	73	66	127	67	42
50	1 1/2"	10	0,80	20	40	1600	82	75	153	86	46
63	2"	10	1,36	12	50	3100	95	89	172	101	58

● beyaz

● bej

● yeşil

● mavi

Çap Dia	Rp (Inch)	EPDM Conta Kod EPDM O-Ring Code	Fiyat (Adet) Price (Pcs)	EPDM Conta Kod EPDM O-Ring Code	Fiyat (Adet) Price (Pcs)	EPDM Conta Kod EPDM O-Ring Code	Fiyat (Adet) Price (Pcs)	EPDM Conta Kod EPDM O-Ring Code	Fiyat (Adet) Price (Pcs)
20	1/2"	411 00 020 2	11,09 €	411 05 020 2	11,09 €	411 10 020 2	11,09 €	411 15 020 2	11,09 €
25	3/4"	411 00 025 2	15,06 €	411 05 025 2	15,06 €	411 10 025 2	15,06 €	411 15 025 2	15,06 €
32	1"	411 00 032 2	19,18 €	411 05 032 2	19,18 €	411 10 032 2	19,18 €	411 15 032 2	19,18 €
40	1 1/4"	411 00 040 2	29,07 €	411 05 040 2	29,07 €	411 10 040 2	29,07 €	411 15 040 2	29,07 €
50	1 1/2"	411 00 050 2	39,33 €	411 05 050 2	39,33 €	411 10 050 2	39,33 €	411 15 050 2	39,33 €
63	2"	411 00 063 2	54,45 €	411 05 063 2	54,45 €	411 10 063 2	54,45 €	411 15 063 2	54,45 €

● ● ● ● Beyaz ürün harici diğer renklerde minimum adet için lütfen sorunuz.

**PP Tek Taraf Piriç Dıştan Dişli Küresel Vana**  
PP One Side Brass Male Threaded Ball Valve

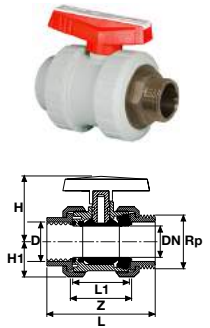

Çap Dia	Rp (Inch)	Basınç PN	Kg/Adet Kg/Pcs	Koli/Adet Box/Pcs	DN (mm)	kv l/min	Z (mm)	L1 (mm)	L (mm)	H (mm)	H1 (mm)
20	1/2"	10	0,19	55	15	185	52	45	112	47	27
25	3/4"	10	0,26	75	20	350	58	49	113	51	31
32	1"	10	0,34	60	25	700	61	54	136	63	33
40	1 1/4"	10	0,57	30	32	1000	73	66	158	67	42
50	1 1/2"	10	0,87	20	40	1600	82	75	173	86	46
63	2"	10	1,48	12	50	3100	95	89	203	101	58

● beyaz

● bej

● yeşil

● mavi

Çap Dia	Rp (Inch)	EPDM Conta Kod EPDM O-Ring Code	Fiyat (Adet) Price (Pcs)	EPDM Conta Kod EPDM O-Ring Code	Fiyat (Adet) Price (Pcs)	EPDM Conta Kod EPDM O-Ring Code	Fiyat (Adet) Price (Pcs)	EPDM Conta Kod EPDM O-Ring Code	Fiyat (Adet) Price (Pcs)
20	1/2"	412 00 020 2	11,67 €	412 05 020 2	11,67 €	412 10 020 2	11,67 €	412 15 020 2	11,67 €
25	3/4"	412 00 025 2	15,80 €	412 05 025 2	15,80 €	412 10 025 2	15,80 €	412 15 025 2	15,80 €
32	1"	412 00 032 2	20,48 €	412 05 032 2	20,48 €	412 10 032 2	20,48 €	412 15 032 2	20,48 €
40	1 1/4"	412 00 040 2	32,05 €	412 05 040 2	32,05 €	412 10 040 2	32,05 €	412 15 040 2	32,05 €
50	1 1/2"	412 00 050 2	42,90 €	412 05 050 2	42,90 €	412 10 050 2	42,90 €	412 15 050 2	42,90 €
63	2"	412 00 063 2	60,06 €	412 05 063 2	60,06 €	412 10 063 2	60,06 €	412 15 063 2	60,06 €

● ● ● ● Beyaz ürün harici diğer renklerde minimum adet için lütfen sorunuz.

## PP Tek Taraf Pirinç İçten Dişli İç Dişli Küresel Vana

### PP One Side Brass Female Threaded Ball Valve

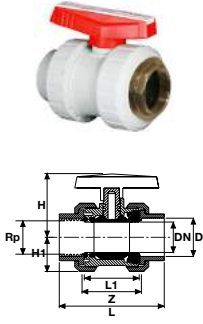

Çap Dia	Rp (Inch)	Basınç PN	Kg/Adet Kg/Pcs	Koli/Adet Box/Pcs	DN (mm)	kv l/min	Z (mm)	L1 (mm)	L (mm)	H (mm)	H1 (mm)
20	1/2"	10	0,20	55	15	185	52	45	86	47	27
25	3/4"	10	0,35	75	20	350	58	49	96	51	31
32	1"	10	0,31	60	25	700	61	54	106	63	33
40	1 1/4"	10		30	32	1000	73	66	127	67	42
50	1 1/2"	10		20	40	1600	82	75	153	86	46
63	2"	10	1,53	12	50	3100	95	89	172	101	58

● beyaz

● bej

● yeşil

● mavi

Çap Dia	Rp (Inch)	EPDM Conta Kod EPDM O-Ring Code	Fiyat (Adet) Price (Pcs)	EPDM Conta Kod EPDM O-Ring Code	Fiyat (Adet) Price (Pcs)	EPDM Conta Kod EPDM O-Ring Code	Fiyat (Adet) Price (Pcs)	EPDM Conta Kod EPDM O-Ring Code	Fiyat (Adet) Price (Pcs)
20	1/2"	414 20 020 2	11,89 €	414 25 020 2	11,89 €	414 30 020 2	11,89 €	414 35 020 2	11,89 €
25	3/4"	414 20 025 2	15,71 €	414 25 025 2	15,71 €	414 30 025 2	15,71 €	414 35 025 2	15,71 €
32	1"	414 20 032 2	20,18 €	414 25 032 2	20,18 €	414 30 032 2	20,18 €	414 35 032 2	20,18 €
40	1 1/4"	414 20 040 2	30,07 €	414 25 040 2	30,07 €	414 30 040 2	30,07 €	414 35 040 2	30,07 €
50	1 1/2"	414 20 050 2	40,53 €	414 25 050 2	40,53 €	414 30 050 2	40,53 €	414 35 050 2	40,53 €
63	2"	414 20 063 2	55,90 €	414 25 063 2	55,90 €	414 30 063 2	55,90 €	414 35 063 2	55,90 €

○ ○ ● ● Beyaz ürün harici diğer renklerde minimum adet için lütfen sorunuz.

## PP Tek Taraf Pirinç Diştan Dişli İç Dişli Küresel Vana

### PP One Side Brass Male Threaded Female Threaded Ball Valve

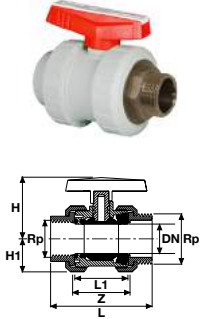

Çap Dia	Rp (Inch)	Basınç PN	Kg/Adet Kg/Pcs	Koli/Adet Box/Pcs	DN (mm)	kv l/min	Z (mm)	L1 (mm)	L (mm)	H (mm)	H1 (mm)
20	1/2"	10	0,21	55	15	185	52	45	112	47	27
25	3/4"	10	0,36	75	20	350	58	49	113	51	31
32	1"	10	0,33	60	25	700	61	54	136	63	33
40	1 1/4"	10	0,66	30	32	1000	73	66	158	67	42
50	1 1/2"	10	0,96	20	40	1600	82	75	173	86	46
63	2"	10	1,62	12	50	3100	95	89	203	101	58

● beyaz

● bej

● yeşil

● mavi

Çap Dia	Rp (Inch)	EPDM Conta Kod EPDM O-Ring Code	Fiyat (Adet) Price (Pcs)	EPDM Conta Kod EPDM O-Ring Code	Fiyat (Adet) Price (Pcs)	EPDM Conta Kod EPDM O-Ring Code	Fiyat (Adet) Price (Pcs)	EPDM Conta Kod EPDM O-Ring Code	Fiyat (Adet) Price (Pcs)
20	1/2"	414 00 020 2	12,47 €	414 05 020 2	12,47 €	414 10 020 2	12,47 €	414 15 020 2	12,47 €
25	3/4"	414 00 025 2	16,45 €	414 05 025 2	16,45 €	414 10 025 2	16,45 €	414 15 025 2	16,45 €
32	1"	414 00 032 2	21,48 €	414 05 032 2	21,48 €	414 10 032 2	21,48 €	414 15 032 2	21,48 €
40	1 1/4"	414 00 040 2	33,05 €	414 05 040 2	33,05 €	414 10 040 2	33,05 €	414 15 040 2	33,05 €
50	1 1/2"	414 00 050 2	44,10 €	414 05 050 2	44,10 €	414 10 050 2	44,10 €	414 15 050 2	44,10 €
63	2"	414 00 063 2	61,51 €	414 05 063 2	61,51 €	414 10 063 2	61,51 €	414 15 063 2	61,51 €

○ ○ ● ● Beyaz ürün harici diğer renklerde minimum adet için lütfen sorunuz.



**PP Kelebek Vana (Çıplak)**  
PP Butterfly Valve (Without Flange)

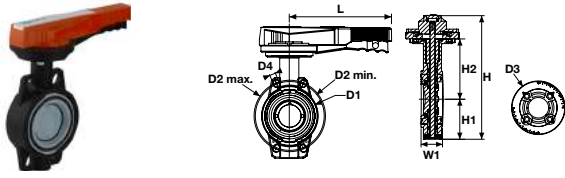

Çap Dia	DN	D1 (mm)	D2 min. (mm)	D2 max. (mm)	D3 (mm)	D4 (mm)	L (mm)	H (mm)	H1 (mm)	H2 (mm)	W1 (mm)	nØe	kv-value l/min.	ISO 5211 ISO 5211
63	50	104	120	125	115	19	207	256	82	126	45	4 x 19	1470	F 07
75	65	115	140	145	115	19	207	265	86	129	46	4 x 19	2200	F 07
90	80	131	150	160	115	19	207	272	89	132	48	8 x 19	3000	F 07
110	100	160	175	190	115	19	207	311	103	156	56	8 x 19	6500	F 07
125	110	190	210	216	115	23	258	338	116	169	63	8 x 23	11500	F 07
140	125	190	210	216	115	23	258	338	116	169	63	8 x 23	11500	F 07
160	150	214	241	241	115	24	258	364	129	182	66	8 x 24	16600	F 07
200	175	268	290	295	115	24	335	414	158	203	75	8 x 24	39600	F 07
225	200	268	290	295	115	24	335	414	158	203	75	8 x 24	39600	F 07

Çap Dia	Basınç PN	Kod Code	Fiyat (Adet) Price (Pcs)	Kg /Adet Kg/Pcs	Koli/Ad. Box/Pcs
63	10	420 00 063 2	41,00 €	1,18	1
75	10	420 00 075 2	45,00 €	1,26	1
90	10	420 00 090 2	48,00 €	1,42	1
110	10	420 00 110 2	55,00 €	2,23	1
125	10	420 00 125 2	62,00 €	2,77	1
140	10	420 00 140 2	62,00 €	2,77	1
160	10	420 00 160 2	79,00 €	3,22	1
200	10	420 00 200 2	132,00 €	5,12	1
225	10	420 00 225 2	132,00 €	5,12	1

**PP Flanşlı Kelebek Vana (Takım)**  
PP Butterfly Valve (With Flange)

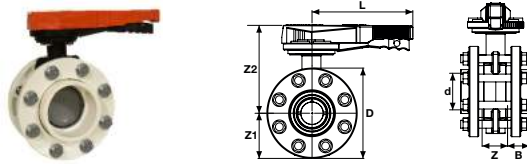

Çap Dia	Basınç PN	Kod Code	Fiyat (Adet) Price (Pcs)	Kg /Adet Kg/Pcs	Koli/Ad. Box/Pcs	DN	D (mm)	Z (mm)	Z1 (mm)	Z2 (mm)	B (mm)	L (mm)	Q1 (mm)	Q2 (mm)	nØe	ISO 5211 ISO 5211	kv-value l/min.
63	10	421 00 063 2	60,00 €	3,00	1	50	165	51	82	188	38	207	37		4 x 19	F 07	1470
75	10	421 00 075 2	65,00 €	3,60	1	65	185	52	92	180	43	207	50	40	4 x 19	F 07	2200
90	10	421 00 090 2	72,00 €	5,45	1	80	200	58	100	183	51	207	65	46	8 x 19	F 07	3000
110	10	421 00 110 2	81,00 €	6,60	1	100	220	66	110	208	60	258	85	68	8 x 19	F 07	6500
125	10	421 00 125 2	95,00 €	9,50	1	110	250	73	125	221	69	258	111	92	8 x 23	F 07	11500
140	10	421 00 140 2	95,00 €	9,90	1	125	250	73	125	221	75	258	111	92	8 x 23	F 07	11500
160	10	421 00 160 2	139,00 €	11,4	1	150	285	76	142	235	86	258	138	122	8 x 24	F 07	16600
200	10	421 00 200 2	195,00 €	17,1	1	175	340	87	170	255	106	335	192	179	8 x 24	F 07	39600
225	10	421 00 225 2	199,00 €	17,1	1	200	340	87	170	255	120	335	192	179	8 x 24	F 07	39600



### PP Flanşlı Kelebek Vana (Takım-304 Paslanmaz Civata-Somun Pul)

PP Butterfly Valve With Flange (304 S.S. Screw, Nut, Washer)

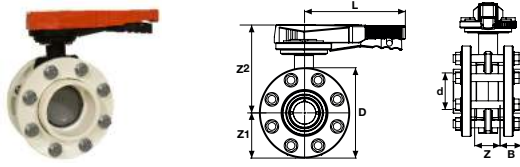

Çap Dia	Basınç PN	Kod Code	Fiyat (Adet) Price (Pcs)	Kg /Adet Kg/Pcs	Koli/Ad. Box/Pcs	DN	D (mm)	Z (mm)	Z1 (mm)	Z2 (mm)	B (mm)	L (mm)	nØe	ISO 5211 ISO 5211	kv-value l/min.
63	10	422 00 063 2	84,00 €	3,00	1	50	165	51	82	188	38	207	4 x 19	F 07	1470
75	10	422 00 075 2	91,00 €	3,60	1	65	185	52	92	180	43	207	4 x 19	F 07	2200
90	10	422 00 090 2	100,80 €	5,45	1	80	200	58	100	183	51	207	8 x 19	F 07	3000
110	10	422 00 110 2	119,00 €	6,60	1	100	220	66	110	208	60	258	8 x 19	F 07	6500
125	10	422 00 125 2	133,00 €	9,50	1	110	250	73	125	221	69	258	8 x 23	F 07	11500
140	10	422 00 140 2	133,00 €	9,90	1	125	250	73	125	221	75	258	8 x 23	F 07	11500
160	10	422 00 160 2	194,60 €	11,4	1	150	285	76	142	235	86	258	8 x 24	F 07	16600
200	10	422 00 200 2	273,00 €	17,1	1	175	340	87	170	255	106	335	8 x 24	F 07	39600
225	10	422 00 225 2	278,60 €	17,1	1	200	340	87	170	255	120	335	8 x 24	F 07	39600

### PP Flanşlı Kelebek Vana (Takım-316 Paslanmaz Civata-Somun Pul)

PP Butterfly Valve With Flange (316 S.S. Screw, Nut, Washer)

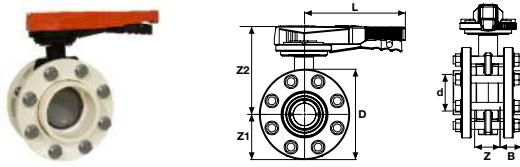

Çap Dia	Basınç PN	Kod Code	Fiyat (Adet) Price (Pcs)	Kg /Adet Kg/Pcs	Koli/Ad. Box/Pcs	DN	D (mm)	Z (mm)	Z1 (mm)	Z2 (mm)	B (mm)	L (mm)	nØe	ISO 5211 ISO 5211	kv-value l/min.
63	10	423 00 063 2	126,00 €	3,00	1	50	165	51	82	188	38	207	4 x 19	F 07	1470
75	10	423 00 075 2	136,50 €	3,60	1	65	185	52	92	180	43	207	4 x 19	F 07	2200
90	10	423 00 090 2	151,20 €	5,45	1	80	200	58	100	183	51	207	8 x 19	F 07	3000
110	10	423 00 110 2	178,50 €	6,60	1	100	220	66	110	208	60	258	8 x 19	F 07	6500
125	10	423 00 125 2	199,50 €	9,50	1	110	250	73	125	221	69	258	8 x 23	F 07	11500
140	10	423 00 140 2	199,50 €	9,90	1	125	250	73	125	221	75	258	8 x 23	F 07	11500
160	10	423 00 160 2	291,90 €	11,4	1	150	285	76	142	235	86	258	8 x 24	F 07	16600
200	10	423 00 200 2	409,50 €	17,1	1	175	340	87	170	255	106	335	8 x 24	F 07	39600
225	10	423 00 225 2	417,90 €	17,1	1	200	340	87	170	255	120	335	8 x 24	F 07	39600



### PP Redüktör Dişli Kelebek Vana (Çıplak)

PP Reduction Gear Butterfly Valve With Handwhell (Without Flange)

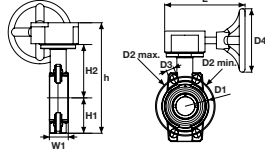

Çap Dia	DN	D1 (mm)	D2 min. (mm)	D2 max. (mm)	D3 (mm)	D4 (mm)	L (mm)	H (mm)	H1 (mm)	H2 (mm)	W1 (mm)	nØe	kv-value l/min.	ISO 5211 ISO 5211
63	50	104	120	125	115	19	192	279	82	126	45	4 x 19	1470	F 07
75	65	115	140	145	115	19	192	288	86	129	46	4 x 19	2200	F 07
90	80	131	150	160	115	19	192	290	89	132	48	8 x 19	3000	F 07
110	100	160	175	190	115	19	192	337	103	156	56	8 x 19	6500	F 07
125	110	190	210	216	115	23	192	353	116	169	63	8 x 23	11500	F 07
140	125	190	210	216	115	23	192	353	116	169	63	8 x 23	11500	F 07
160	150	214	241	241	115	24	192	375	129	182	66	8 x 24	16600	F 07
200	175	268	290	295	115	24	192	429	158	203	75	8 x 24	39600	F 07
225	200	268	290	295	115	24	192	429	158	203	75	8 x 24	39600	F 07

Çap Dia	Basınç PN	Kod Code	Fiyat (Adet) Price (Pcs)	Kg /Adet Kg/Pcs	Koli/Ad. Box/Pcs
63	10	424 00 063 2	71,00 €	1,12	1
75	10	424 00 075 2	75,00 €	4,65	1
90	10	424 00 090 2	78,00 €	1,12	1
110	10	424 00 110 2	85,00 €	5,57	1
125	10	424 00 125 2	92,00 €	7,53	1
140	10	424 00 140 2	92,00 €		1
160	10	424 00 160 2	109,00 €	8,14	1
200	10	424 00 200 2	162,00 €	10,9	1
225	10	424 00 225 2	162,00 €	10,9	1

### PP Redüktör Dişli Flanşlı Kelebek Vana (Takım)

PP Reduction Gear Butterfly Valve With Handwhell and Flange

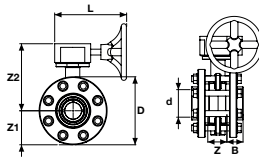

Çap Dia	Basınç PN	Kod Code	Fiyat (Adet) Price (Pcs)	Kg /Adet Kg/Pcs	Koli/Ad. Box/Pcs	DN	D (mm)	Z (mm)	Z1 (mm)	Z2 (mm)	B (mm)	L (mm)	nØe	kv-value l/min.	ISO 5211 ISO 5211
63	10	425 00 063 2	80,00 €	3,00	1	50	165	51	82	196	38	192	4 x 19	1470	F 07
75	10	425 00 075 2	95,00 €	3,60	1	65	185	52	92	191	43	192	4 x 19	2200	F 07
90	10	425 00 090 2	102,00 €	5,45	1	80	200	58	100	190	51	192	8 x 19	3000	F 07
110	10	425 00 110 2	111,00 €	6,60	1	100	220	66	110	227	60	192	8 x 19	6500	F 07
125	10	425 00 125 2	125,00 €	9,50	1	110	250	73	125	228	69	192	8 x 23	11500	F 07
140	10	425 00 140 2	125,00 €	9,90	1	125	250	73	125	228	75	192	8 x 23	11500	F 07
160	10	425 00 160 2	169,00 €	11,4	1	150	285	76	142	232	86	192	8 x 24	16600	F 07
200	10	425 00 200 2	225,00 €	17,1	1	175	340	87	170	259	106	192	8 x 24	39600	F 07
225	10	425 00 225 2	229,00 €	17,1	1	200	340	87	170	259	120	192	8 x 24	39600	F 07



### PP Redüktör Dişli Flanşlı Kelebek Vana (Takım-304 Paslanmaz Civata-Somun-Pul)

PP Reduction Gear Butterfly Valve With Handwhell and Flange (304 S.S. Screw,Nut,Washer)

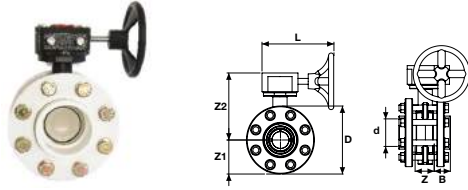

Çap Dia	Basınç PN	Kod Code	Fiyat (Adet) Price (Pcs)	Kg /Adet Kg/Pcs	Koli/Ad. Box/Pcs	DN	D (mm)	Z (mm)	Z1 (mm)	Z2 (mm)	B (mm)	L (mm)	nØe	Inch	kv-value l/min.	ISO 5211 ISO 5211
63	10	426 00 063 2	114,00 €		1	50	165	51	82	196	38	192	4 x 19	2"	1470	F 07
75	10	426 00 075 2	121,00 €		1	65	185	52	92	191	43	192	4 x 19	2 1/2"	2200	F 07
90	10	426 00 090 2	130,80 €		1	80	200	58	100	190	51	192	8 x 19	3"	3000	F 07
110	10	426 00 110 2	149,00 €		1	100	220	66	110	227	60	192	8 x 19	4"	6500	F 07
125	10	426 00 125 2	163,00 €		1	110	250	73	125	228	69	192	8 x 23	4 1/2"	11500	F 07
140	10	426 00 140 2	163,00 €	12,5	1	125	250	73	125	228	75	192	8 x 23	5"	11500	F 07
160	10	426 00 160 2	224,60 €		1	150	285	76	142	232	86	192	8 x 24	6"	16600	F 07
200	10	426 00 200 2	303,00 €	17,1	1	175	340	87	170	259	106	192	8 x 24	7"	39600	F 07
225	10	426 00 225 2	308,60 €		1	200	340	87	170	259	120	192	8 x 24	8"	39600	F 07

### PP Redüktör Dişli Flanşlı Kelebek Vana (Takım-316 Paslanmaz Civata-Somun-Pul)

PP Reduction Gear Butterfly Valve With Handwhell and Flange (316 S.S. Screw,Nut,Washer)

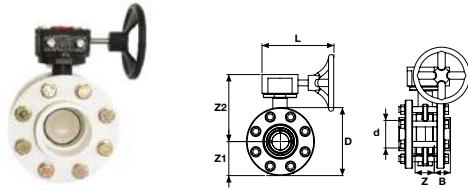

Çap Dia	Basınç PN	Kod Code	Fiyat (Adet) Price (Pcs)	Kg /Adet Kg/Pcs	Koli/Ad. Box/Pcs	DN	D (mm)	Z (mm)	Z1 (mm)	Z2 (mm)	B (mm)	L (mm)	nØe	ISO 5211 ISO 5211	Inch	kv-value l/min.
63	10	427 00 063 2	156,00 €		1	50	165	51	82	196	38	192	4 x 19	F 07	2"	1470
75	10	427 00 075 2	166,50 €		1	65	185	52	92	191	43	192	4 x 19	F 07	2 1/2"	2200
90	10	427 00 090 2	181,20 €		1	80	200	58	100	190	51	192	8 x 19	F 07	3"	3000
110	10	427 00 110 2	208,50 €		1	100	220	66	110	227	60	192	8 x 19	F 07	4"	6500
125	10	427 00 125 2	229,50 €		1	110	250	73	125	228	69	192	8 x 23	F 07	4 1/2"	11500
140	10	427 00 140 2	229,50 €		1	125	250	73	125	228	75	192	8 x 23	F 07	5"	11500
160	10	427 00 160 2	321,90 €		1	150	285	76	142	232	86	192	8 x 24	F 07	6"	16600
200	10	427 00 200 2	439,50 €		1	175	340	87	170	259	106	192	8 x 24	F 07	7"	39600
225	10	427 00 225 2	447,90 €		1	200	340	87	170	259	120	192	8 x 24	F 07	8"	39600



PP Rakor  
PP Union

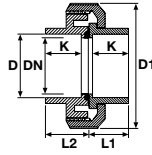

Çap Dia	Basınç PN	Kg /Adet Kg/Pcs	Koli/Ad. Box/Pcs	DN (mm)	D1 (mm)	L1 (mm)	L2 (mm)	K (mm)
20	10	0,05	125	15	54	19	24	16
25	10	0,07	100	20	62	22	27	19
32	10	0,09	50	25	65	25	30	22
40	10	0,16	30	32	83	28	36	26
50	10	0,189	45	40	93	38	42	31
63	10	0,35	25	50	116	41	52	38
75	10	0,585	18	65	129	47	54	44
90	10	0,98	9	80	155	56	61	51
110	10	1,47	7	100	178	66	71	61

● beyaz

● bej

● yeşil

● mavi

Çap Dia	EPDM Conta Kod EPDM O-Ring Code	Fiyat (Adet) Price (Pcs)	EPDM Conta Kod EPDM O-Ring Code	Fiyat (Adet) Price (Pcs)	EPDM Conta Kod EPDM O-Ring Code	Fiyat (Adet) Price (Pcs)	EPDM Conta Kod EPDM O-Ring Code	Fiyat (Adet) Price (Pcs)
20	406 00 020 2	1,35 €	406 20 020 2	1,35 €	406 40 020 2	1,35 €	406 60 020 2	1,35 €
25	406 00 025 2	1,90 €	406 20 025 2	1,90 €	406 40 025 2	1,90 €	406 60 025 2	1,90 €
32	406 00 032 2	2,60 €	406 20 032 2	2,60 €	406 40 032 2	2,60 €	406 60 032 2	2,60 €
40	406 00 040 2	2,85 €	406 20 040 2	2,85 €	406 40 040 2	2,85 €	406 60 040 2	2,85 €
50	406 00 050 2	3,90 €	406 20 050 2	3,90 €	406 40 050 2	3,90 €	406 60 050 2	3,90 €
63	406 00 063 2	4,60 €	406 20 063 2	4,60 €	406 40 063 2	4,60 €	406 60 063 2	4,60 €
75	406 00 075 2	11,50 €	406 20 075 2	11,50 €	406 40 075 2	11,50 €	406 60 075 2	11,50 €
90	406 00 090 2	16,00 €	406 20 090 2	16,00 €	406 40 090 2	16,00 €	406 60 090 2	16,00 €
110	406 00 110 2	21,00 €	406 20 110 2	21,00 €	406 40 110 2	21,00 €	406 60 110 2	21,00 €

● ● ● ● Beyaz ürün harici diğer renklerde minimum adet için lütfen sorunuz.

PP Tek Taraf İçten Dişli Rakor  
PP One Side Female Threaded Union

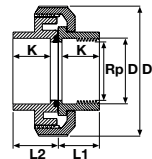

Çap Dia	Rp (Inch)	Basınç PN	Kg /Adet Kg/Pcs	Koli/Ad. Box/Pcs	DN (mm)	D1 (mm)	L1 (mm)	L2 (mm)	K (mm)
20	1/2"	10	0,05	125	15	54	19	24	16
25	3/4"	10	0,07	100	20	62	22	27	19
32	1"	10	0,085	50	25	65	25	30	22
40	1 1/4"	10	0,155	30	32	83	28	36	26
50	1 1/2"	10	0,25	45	40	93	38	42	31
63	2"	10	0,48	25	50	116	41	52	38
75	2 1/2"	10	0,6	18	65	129	47	54	44
90	3"	10	1,005	9	80	155	56	61	51
110	4"	10	1,485	7	100	178	66	71	61

● beyaz

● bej

● yeşil

● mavi

Çap Dia	Rp (Inch)	EPDM Conta Kod EPDM O-Ring Code	Fiyat (Adet) Price (Pcs)	EPDM Conta Kod EPDM O-Ring Code	Fiyat (Adet) Price (Pcs)	EPDM Conta Kod EPDM O-Ring Code	Fiyat (Adet) Price (Pcs)	EPDM Conta Kod EPDM O-Ring Code	Fiyat (Adet) Price (Pcs)
20	1/2"	407 00 020 2	2,00 €	407 20 020 2	2,00 €	407 40 020 2	2,00 €	407 60 020 2	2,00 €
25	3/4"	407 00 025 2	2,60 €	407 20 025 2	2,60 €	407 40 025 2	2,60 €	407 60 025 2	2,60 €
32	1"	407 00 032 2	3,50 €	407 20 032 2	3,50 €	407 40 032 2	3,50 €	407 60 032 2	3,50 €
40	1 1/4"	407 00 040 2	3,80 €	407 20 040 2	3,80 €	407 40 040 2	3,80 €	407 60 040 2	3,80 €
50	1 1/2"	407 00 050 2	5,00 €	407 20 050 2	5,00 €	407 40 050 2	5,00 €	407 60 050 2	5,00 €
63	2"	407 00 063 2	6,00 €	407 20 063 2	6,00 €	407 40 063 2	6,00 €	407 60 063 2	6,00 €
75	2 1/2"	407 00 075 2	13,50 €	407 20 075 2	13,50 €	407 40 075 2	13,50 €	407 60 075 2	13,50 €
90	3"	407 00 090 2	18,00 €	407 20 090 2	18,00 €	407 40 090 2	18,00 €	407 60 090 2	18,00 €
110	4"	407 00 110 2	23,00 €	407 20 110 2	23,00 €	407 40 110 2	23,00 €	407 60 110 2	23,00 €

● ● ● ● Beyaz ürün harici diğer renklerde minimum adet için lütfen sorunuz.

## PP Çift Taraf İçten Dişli Rakor

### PP Both Sides Female Threaded Union

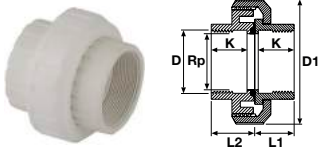

Rp (Inch)	Basınç PN	Kg /Adet Kg/Pcs	Koli/Ad. Box/Pcs	DN (mm)	D1 (mm)	L1 (mm)	L2 (mm)	K (mm)
1/2"	10	0,05	125	15	54	19	24	16
3/4"	10	0,07	100	20	62	22	27	19
1"	10	0,09	50	25	65	25	30	22
1 1/4"	10	0,15	30	32	83	28	36	26
1 1/2"	10	0,25	45	40	93	38	42	31
2"	10	0,5	25	50	116	41	52	38
2 1/2"	10	0,61	18	65	129	47	54	44
3"	10	1,04	10	80	155	56	61	51
4"	10	1,415	7	100	178	66	71	61

● beyaz

● bej

● yeşil

● mavi

Rp (Inch)	EPDM Conta Kod EPDM O-Ring Code	Fiyat (Adet) Price (Pcs)	EPDM Conta Kod EPDM O-Ring Code	Fiyat (Adet) Price (Pcs)	EPDM Conta Kod EPDM O-Ring Code	Fiyat (Adet) Price (Pcs)	EPDM Conta Kod EPDM O-Ring Code	Fiyat (Adet) Price (Pcs)
1/2"	408 00 020 2	2,50 €	408 20 020 2	2,50 €	408 40 020 2	2,50 €	408 60 020 2	2,50 €
3/4"	408 00 025 2	3,10 €	408 20 025 2	3,10 €	408 40 025 2	3,10 €	408 60 025 2	3,10 €
1"	408 00 032 2	4,10 €	408 20 032 2	4,10 €	408 40 032 2	4,10 €	408 60 032 2	4,10 €
1 1/4"	408 00 040 2	4,35 €	408 20 040 2	4,35 €	408 40 040 2	4,35 €	408 60 040 2	4,35 €
1 1/2"	408 00 050 2	5,90 €	408 20 050 2	5,90 €	408 40 050 2	5,90 €	408 60 050 2	5,90 €
2"	408 00 063 2	6,85 €	408 20 063 2	6,85 €	408 40 063 2	6,85 €	408 60 063 2	6,85 €
2 1/2"	408 00 075 2	14,20 €	408 20 075 2	14,20 €	408 40 075 2	14,20 €	408 60 075 2	14,20 €
3"	408 00 090 2	19,50 €	408 20 090 2	19,50 €	408 40 090 2	19,50 €	408 60 090 2	19,50 €
4"	408 00 110 2	24,90 €	408 20 110 2	24,90 €	408 40 110 2	24,90 €	408 60 110 2	24,90 €

● ● ● ● Beyaz ürün harici diğer renklerde minimum adet için lütfen sorunuz.



**İç Diş Pirinç Rakor PP Çıkışı**  
Female Threaded Brass Union Outlet PP

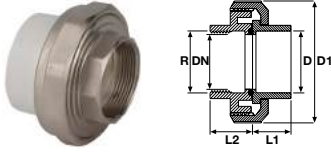

Çap Dia	R Inch	Basınç PN	Kg /Adet Kg/Pcs	Koli/Adet Box/Pcs	DN (mm)	D1 (mm)	L1 (mm)	L2 (mm)
20	1/2"	10	0,075	125	15	36	19	14
25	3/4"	10	0,108	100	20	45	22	15
32	1"	10	0,155	50	25	51	25	17
40	1 1/4"	10	0,28	30	32	64	28	24
50	1 1/2"	10	0,41	45	40	80	38	22
63	2"	10	0,77	25	50	98	41	23

● beyaz

● bej

● yeşil

● mavi

Çap Dia	Rp (Inch)	EPDM Conta Kod EPDM O-Ring Code	Fiyat (Adet) Price (Pcs)	EPDM Conta Kod EPDM O-Ring Code	Fiyat (Adet) Price (Pcs)	EPDM Conta Kod EPDM O-Ring Code	Fiyat (Adet) Price (Pcs)	EPDM Conta Kod EPDM O-Ring Code	Fiyat (Adet) Price (Pcs)
20	1/2"	410 00 020 2	2,66 €	410 40 020 2	2,66 €	410 60 020 2	2,66 €	418 60 020 2	2,66 €
25	3/4"	410 00 025 2	3,68 €	410 40 025 2	3,68 €	410 60 025 2	3,68 €	418 60 025 2	3,68 €
32	1"	410 00 032 2	4,57 €	410 40 032 2	4,57 €	410 60 032 2	4,57 €	418 60 032 2	4,57 €
40	1 1/4"	410 00 040 2	8,57 €	410 40 040 2	8,57 €	410 60 040 2	8,57 €	418 60 040 2	8,57 €
50	1 1/2"	410 00 050 2	13,17 €	410 40 050 2	13,17 €	410 60 050 2	13,17 €	418 60 050 2	13,17 €
63	2"	410 00 063 2	19,17 €	410 40 063 2	19,17 €	410 60 063 2	19,17 €	418 60 063 2	19,17 €

● ● ● ● Beyaz ürün harici diğer renklerde minimum adet için lütfen sorunuz.

**Diş Diş Pirinç Rakor PP Çıkışı**  
Male Threaded Brass Union Outlet PP

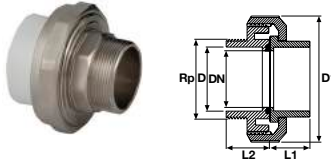

Çap Dia	Rp Inch	Basınç PN	Kg /Adet Kg/Pcs	Koli/Adet Box/Pcs	DN (mm)	D1 (mm)	L1 (mm)	L2 (mm)
20	1/2"	10	0,085	125	15	36	19	14
25	3/4"	10	0,14	100	20	45	22	15
32	1"	10	0,172	50	25	51	25	17
40	1 1/4"	10	0,34	50	32	64	28	24
50	1 1/2"	10	0,524	30	40	80	38	22
63	2"	10	0,68	24	50	98	41	23

● beyaz

● bej

● yeşil

● mavi

Çap Dia	Rp (Inch)	EPDM Conta Kod EPDM O-Ring Code	Fiyat (Adet) Price (Pcs)	EPDM Conta Kod EPDM O-Ring Code	Fiyat (Adet) Price (Pcs)	EPDM Conta Kod EPDM O-Ring Code	Fiyat (Adet) Price (Pcs)	EPDM Conta Kod EPDM O-Ring Code	Fiyat (Adet) Price (Pcs)
20	1/2"	410 10 020 2	2,89 €	410 45 020 2	2,89 €	410 65 020 2	2,89 €	418 65 020 2	2,89 €
25	3/4"	410 10 025 2	3,97 €	410 45 025 2	3,97 €	410 65 025 2	3,97 €	418 65 025 2	3,97 €
32	1"	410 10 032 2	5,08 €	410 45 032 2	5,08 €	410 65 032 2	5,08 €	418 65 032 2	5,08 €
40	1 1/4"	410 10 040 2	9,73 €	410 45 040 2	9,73 €	410 65 040 2	9,73 €	418 65 040 2	9,73 €
50	1 1/2"	410 10 050 2	14,55 €	410 45 050 2	14,55 €	410 65 050 2	14,55 €	418 65 050 2	14,55 €
63	2"	410 10 063 2	21,35 €	410 45 063 2	21,35 €	410 65 063 2	21,35 €	418 65 063 2	21,35 €

● ● ● ● Beyaz ürün harici diğer renklerde minimum adet için lütfen sorunuz.

## PP Rakor İç Diş Pirinç Çıkışlı

### PP Union Outlet Female Threaded Brass

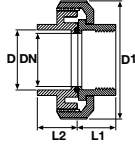

Çap Dia	R Inch	Basınç PN	Kg /Adet Kg/Pcs	Koli/Adet Box/Pcs	DN (mm)	D1 (mm)	L1 (mm)	L2 (mm)
20	1/2"	10	0,09	125	15	36	19	14
25	3/4"	10	0	100	20	45	21	15
32	1"	10	0,15	50	25	51	25	17
40	1 1/4"	10	1	50	32	64	29	24
50	1 1/2"	10	0,395	30	40	80	34	22
63	2"	10	0,66	10	50	98	41	23

● beyaz

● bej

● yeşil

● mavi

Çap Dia	Rp (Inch)	● beyaz		● bej		● yeşil		● mavi	
		EPDM Conta Kod EPDM O-Ring Code	Fiyat (Adet) Price (Pcs)	EPDM Conta Kod EPDM O-Ring Code	Fiyat (Adet) Price (Pcs)	EPDM Conta Kod EPDM O-Ring Code	Fiyat (Adet) Price (Pcs)	EPDM Conta Kod EPDM O-Ring Code	Fiyat (Adet) Price (Pcs)
20	1/2"	410 20 020 2	1,97 €	410 50 020 2	1,97 €	410 70 020 2	1,97 €	418 70 020 2	1,97 €
25	3/4"	410 10 025 2	3,22 €	410 50 025 2	3,22 €	410 70 025 2	3,22 €	418 70 025 2	3,22 €
32	1"	410 10 032 2	4,16 €	410 50 032 2	4,16 €	410 70 032 2	4,16 €	418 70 032 2	4,16 €
40	1 1/4"	410 10 040 2	7,64 €	410 50 040 2	7,64 €	410 70 040 2	7,64 €	418 70 040 2	7,64 €
50	1 1/2"	410 10 050 2	10,87 €	410 50 050 2	10,87 €	410 70 050 2	10,87 €	418 70 050 2	10,87 €
63	2"	410 10 063 2	17,20 €	410 50 063 2	17,20 €	410 70 063 2	17,20 €	418 70 063 2	17,20 €

○ ○ ● ● Beyaz ürün harici diğer renklerde minimum adet için lütfen sorunuz.

## PP Rakor Dış Diş Pirinç Çıkışlı

### PP Union Outlet Male Threaded Brass

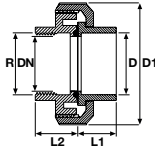

Çap Dia	R Inch	Basınç PN	Kg /Adet Kg/Pcs	Koli/Adet Box/Pcs	DN (mm)	D1 (mm)	L1 (mm)	L2 (mm)
20	1/2"	10	0,075	50	15	36	19	14
25	3/4"	10	0,108	100	20	45	22	15
32	1"	10	0,155	90	25	51	25	17
40	1 1/4"	10	0,28	80	32	64	28	24
50	1 1/2"	10	0,41	30	40	80	38	22
63	2"	10	0,77	24	50	98	41	23

● beyaz

● bej

● yeşil

● mavi

Çap Dia	Rp (Inch)	● beyaz		● bej		● yeşil		● mavi	
		EPDM Conta Kod EPDM O-Ring Code	Fiyat (Adet) Price (Pcs)	EPDM Conta Kod EPDM O-Ring Code	Fiyat (Adet) Price (Pcs)	EPDM Conta Kod EPDM O-Ring Code	Fiyat (Adet) Price (Pcs)	EPDM Conta Kod EPDM O-Ring Code	Fiyat (Adet) Price (Pcs)
20	1/2"	410 30 020 2	2,19 €	410 55 020 2	2,19 €	410 75 020 2	2,19 €	418 75 020 2	2,19 €
25	3/4"	410 30 025 2	3,51 €	410 55 025 2	3,51 €	410 75 025 2	3,51 €	418 75 025 2	3,51 €
32	1"	410 30 032 2	4,67 €	410 55 032 2	4,67 €	410 75 032 2	4,67 €	418 75 032 2	4,67 €
40	1 1/4"	410 30 040 2	9,03 €	410 55 040 2	9,03 €	410 75 040 2	9,03 €	418 75 040 2	9,03 €
50	1 1/2"	410 30 050 2	12,25 €	410 55 050 2	12,25 €	410 75 050 2	12,25 €	418 75 050 2	12,25 €
63	2"	410 30 063 2	19,75 €	410 55 063 2	19,75 €	410 75 063 2	19,75 €	418 75 063 2	19,75 €

○ ○ ● ● Beyaz ürün harici diğer renklerde minimum adet için lütfen sorunuz.



**PP Yaylı Çekvalf**  
PP Spring Checkvalve

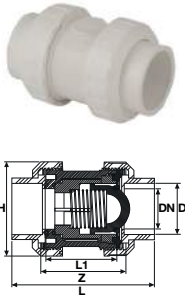

Çap Dia	Basınç PN	Kg/Adet Kg/Pcs	Koli/Adet Box/Pcs	DN (mm)	H (mm)	L (mm)	L1 (mm)	Z (mm)
20	10	0,11	60	16	54	85	45	52
25	10	0,14	75	20	62	95	49	58
32	10	0,20	60	25	66	107	54	61
40	10	0,37	32	32	84	128	66	73
50	10	0,53	20	40	92	154	75	82
63	10	0,95	13	50	116	172	89	95
75	10	1,21	9	65	146	196	111	118
90	10	3,15	4	80	178	241	126	139
110	10	4,59	2	100	210	289	153	165

● beyaz

● bej

● yeşil

● mavi

Çap Dia	EPDM Conta Kod EPDM O-Ring Code	Fiyat (Adet) Price (Pcs)	EPDM Conta Kod EPDM O-Ring Code	Fiyat (Adet) Price (Pcs)	EPDM Conta Kod EPDM O-Ring Code	Fiyat (Adet) Price (Pcs)	EPDM Conta Kod EPDM O-Ring Code	Fiyat (Adet) Price (Pcs)
20	413 00 020 2	5,25 €	413 20 020 2	5,25 €	413 40 020 2	5,25 €	413 60 020 2	5,25 €
25	413 00 025 2	5,75 €	413 20 025 2	5,75 €	413 40 025 2	5,75 €	413 60 025 2	5,75 €
32	413 00 032 2	7,15 €	413 20 032 2	7,15 €	413 40 032 2	7,15 €	413 60 032 2	7,15 €
40	413 00 040 2	7,85 €	413 20 040 2	7,85 €	413 40 040 2	7,85 €	413 60 040 2	7,85 €
50	413 00 050 2	8,85 €	413 20 050 2	8,85 €	413 40 050 2	8,85 €	413 60 050 2	8,85 €
63	413 00 063 2	11,75 €	413 20 063 2	11,75 €	413 40 063 2	11,75 €	413 60 063 2	11,75 €
75	413 00 075 2	27,80 €	413 20 075 2	27,80 €	413 40 075 2	27,80 €	413 60 075 2	27,80 €
90	413 00 090 2	30,80 €	413 20 090 2	30,80 €	413 40 090 2	30,80 €	413 60 090 2	30,80 €
110	413 00 110 2	53,80 €	413 20 110 2	53,80 €	413 40 110 2	53,80 €	413 60 110 2	53,80 €

**PP Tek Taraf İçten Dişli Yaylı Çekvalf**  
PP One Side Female Threaded Spring Checkvalve



Çap Dia	Rp Inch	Basınç PN	Kg/Adet Kg/Pcs	Koli/Adet Box/Pcs	DN (mm)	H (mm)	L (mm)	L1 (mm)	Z (mm)
20	1/2"	10	0,11	60	16	54	85	45	52
25	3/4"	10	0,14	75	20	62	95	49	58
32	1"	10	0,20	60	25	66	107	54	61
40	1 1/4"	10	0,37	32	32	84	128	66	73
50	1 1/2"	10	0,53	20	40	92	154	75	82
63	2"	10	0,95	13	50	116	172	89	95
75	2 1/2"	10	1,21	9	65	146	196	111	118
90	3"	10	3,15	4	80	178	241	126	139
110	4"	10	4,59	2	100	210	289	153	165

● beyaz

● bej

● yeşil

● mavi

Çap Dia	Rp Inch	EPDM Conta Kod EPDM O-Ring Code	Fiyat (Adet) Price (Pcs)	EPDM Conta Kod EPDM O-Ring Code	Fiyat (Adet) Price (Pcs)	EPDM Conta Kod EPDM O-Ring Code	Fiyat (Adet) Price (Pcs)	EPDM Conta Kod EPDM O-Ring Code	Fiyat (Adet) Price (Pcs)
20	1/2"	404 00 020 2	5,85 €	404 20 020 2	5,85 €	404 40 020 2	5,85 €	404 60 020 2	5,85 €
25	3/4"	404 00 025 2	6,35 €	404 20 025 2	6,35 €	404 40 025 2	6,35 €	404 60 025 2	6,35 €
32	1"	404 00 032 2	7,85 €	404 20 032 2	7,85 €	404 40 032 2	7,85 €	404 60 032 2	7,85 €
40	1 1/4"	404 00 040 2	8,55 €	404 20 040 2	8,55 €	404 40 040 2	8,55 €	404 60 040 2	8,55 €
50	1 1/2"	404 00 050 2	9,75 €	404 20 050 2	9,75 €	404 40 050 2	9,75 €	404 60 050 2	9,75 €
63	2"	404 00 063 2	12,50 €	404 20 063 2	12,50 €	404 40 063 2	12,50 €	404 60 063 2	12,50 €
75	2 1/2"	404 00 075 2	29,00 €	404 20 075 2	29,00 €	404 40 075 2	29,00 €	404 60 075 2	29,00 €
90	3"	404 00 090 2	32,00 €	404 20 090 2	32,00 €	404 40 090 2	32,00 €	404 60 090 2	32,00 €
110	4"	404 00 110 2	55,00 €	404 20 110 2	55,00 €	404 40 110 2	55,00 €	404 60 110 2	55,00 €



## PP Çift Taraf İçten Dişli Yaylı Çekvalf

### PP Both Sides Female Threaded Spring Checkvalve



Rp Inch	Basınç PN	Kg/Adet Kg/Pcs	Koli/Adet Box/Pcs	DN (mm)	H (mm)	L (mm)	L1 (mm)	Z (mm)
1/2"	10	0,11	60	16	54	85	45	52
3/4"	10	0,15	75	20	62	95	49	58
1"	10	0,19	60	25	66	107	54	61
1 1/4"	10	0,36	32	32	84	128	66	73
1 1/2"	10	0,55	20	40	92	154	75	82
2"	10	1,01	13	50	116	172	89	95
2 1/2"	10	1,24	9	65	146	196	111	118
3"	10	3,17	4	80	178	241	126	139
4"	10	4,45	2	100	210	289	153	165

● beyaz

● bej

● yeşil

● mavi

Rp Inch	EPDM Conta Kod EPDM O-Ring Code	Fiyat (Adet) Price (Pcs)	EPDM Conta Kod EPDM O-Ring Code	Fiyat (Adet) Price (Pcs)	EPDM Conta Kod EPDM O-Ring Code	Fiyat (Adet) Price (Pcs)	EPDM Conta Kod EPDM O-Ring Code	Fiyat (Adet) Price (Pcs)
1/2"	405 00 020 2	6,45 €	405 20 020 2	6,45 €	405 40 020 2	6,45 €	405 60 020 2	6,45 €
3/4"	405 00 025 2	6,95 €	405 20 025 2	6,95 €	405 40 025 2	6,95 €	405 60 025 2	6,95 €
1"	405 00 032 2	8,50 €	405 20 032 2	8,50 €	405 40 032 2	8,50 €	405 60 032 2	8,50 €
1 1/4"	405 00 040 2	9,20 €	405 20 040 2	9,20 €	405 40 040 2	9,20 €	405 60 040 2	9,20 €
1 1/2"	405 00 050 2	10,50 €	405 20 050 2	10,50 €	405 40 050 2	10,50 €	405 60 050 2	10,50 €
2"	405 00 063 2	13,50 €	405 20 063 2	13,50 €	405 40 063 2	13,50 €	405 60 063 2	13,50 €
2 1/2"	405 00 075 2	30,00 €	405 20 075 2	30,00 €	405 40 075 2	30,00 €	405 60 075 2	30,00 €
3"	405 00 090 2	33,00 €	405 20 090 2	33,00 €	405 40 090 2	33,00 €	405 60 090 2	33,00 €
4"	405 00 110 2	56,00 €	405 20 110 2	56,00 €	405 40 110 2	56,00 €	405 60 110 2	56,00 €

## PP Flanş Bağlantılı Yaylı Çekvalf

### PP Both Sides Flanged Spring Checkvalve

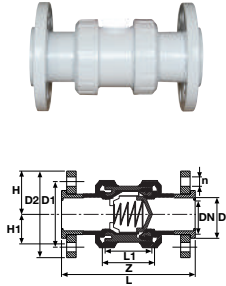

Çap Dia	Basınç PN	Kg/Adet Kg/Pcs	Koli/Adet Box/Pcs	DN (mm)	Z (mm)	L1 (mm)	L (mm)	H (mm)	D1 (mm)	D2 (mm)	n (mm)
20	10		60	16	52	45	123	54	65	96	14x4
25	10		75	20	58	49	140	62	75	105	14x4
32	10		60	25	61	54	158	66	85	115	14x4
40	10		32	32	73	66	186	84	100	140	14x4
50	10		24	40	82	75	231	92	100	150	18x4
63	10		13	50	95	89	253	116	125	165	18x4
75	10		9	65	118	111	291	146	145	185	18x4
90	10		4	80	139	126	353	178	160	200	18x8
110	10		2	100	165	153	431	210	180	220	18x8

● beyaz

● bej

● yeşil

● mavi

Çap Dia	EPDM Conta Kod EPDM O-Ring Code	Fiyat (Adet) Price (Pcs)	EPDM Conta Kod EPDM O-Ring Code	Fiyat (Adet) Price (Pcs)	EPDM Conta Kod EPDM O-Ring Code	Fiyat (Adet) Price (Pcs)	EPDM Conta Kod EPDM O-Ring Code	Fiyat (Adet) Price (Pcs)
20	405 10 020 2	9,33 €	405 50 020 2	9,33 €	405 30 020 2	9,33 €	405 70 020 2	9,33 €
25	405 10 025 2	9,83 €	405 50 025 2	9,83 €	405 30 025 2	9,83 €	405 70 025 2	9,83 €
32	405 10 032 2	11,95 €	405 50 032 2	11,95 €	405 30 032 2	11,95 €	405 70 032 2	11,95 €
40	405 10 040 2	13,35 €	405 50 040 2	13,35 €	405 30 040 2	13,35 €	405 70 040 2	13,35 €
50	405 10 050 2	14,35 €	405 50 050 2	14,35 €	405 30 050 2	14,35 €	405 70 050 2	14,35 €
63	405 10 063 2	17,65 €	405 50 063 2	17,65 €	405 30 063 2	17,65 €	405 70 063 2	17,65 €
75	405 10 075 2	35,36 €	405 50 075 2	35,36 €	405 30 075 2	35,36 €	405 70 075 2	35,36 €
90	405 10 090 2	39,68 €	405 50 090 2	39,68 €	405 30 090 2	39,68 €	405 70 090 2	39,68 €
110	405 10 110 2	64,88 €	405 50 110 2	64,88 €	405 30 110 2	64,88 €	405 70 110 2	64,88 €



**PP Çalparalı Çekvalf Çıplak**  
PP Wafer Checkvalve Without Flange

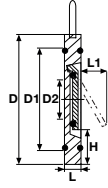

Düşük Dayanımlı Asit İçin  
For Low Strength Acid

Yüksek Dayanımlı Asit İçin  
For High Strength Acid

Çap Dia	Basınç PN	EPDM Conta Kod EPDM O-Ring Code	Fiyat (Adet) Price (Pcs)	FPM Conta Kod FPM O-Ring Code	Fiyat (Adet) Price (Pcs)	Kg /Adet Kg/Pcs	Koli/Ad. Box/Pcs	DN (mm)	D (mm)	D1 (mm)	D2 (mm)	L (mm)	L1 (mm)	H (mm)
63	10	428 01 063 2	20,75 €	428 02 063 2	28,20 €		40	50	90	75	32	16	40	18
75	10	428 01 075 2	25,75 €	428 02 075 2	34,70 €		30	65	110	95	40	16	55	20
90	10	428 01 090 2	28,75 €	428 02 090 2	38,60 €		25	80	125	115	54	16	67	23
110	10	428 01 110 2	33,85 €	428 02 110 2	45,30 €		20	100	184	135	70	19	67	35
125	10	428 01 125 2	38,80 €	428 02 125 2	51,70 €		15	100	213	160	92	21	94	37
140	10	428 01 140 2	44,40 €	428 02 140 2	60,30 €		15	125	213	160	92	21	94	37
160	10	428 01 160 2	50,00 €	428 02 160 2	68,20 €		15	150	251	175	105	23	100	47
200	10	428 01 200 2	62,00 €	428 02 200 2	85,15 €		10	200	280	235	155	27	152	41
225	10	428 01 225 2	71,00 €	428 02 225 2	92,30 €		10	200	280	235	155	27	152	41
250	10	428 01 250 2	135,00 €	428 02 250 2	195,00 €		2	250	330	285	190	40	180	41
280	10	428 01 280 2	203,00 €	428 02 280 2	248,00 €		1	250	330	285	190	40	180	41
315	10	428 01 315 2	275,00 €	428 02 315 2	377,00 €		1	300	380	325	235	45	215	41
400	10	428 01 400 2	600,00 €	428 02 400 2	780,00 €		1							

**PP Çalparalı Çekvalf Flanş Bağlantılı**  
PP Wafer Checkvalve With Flange

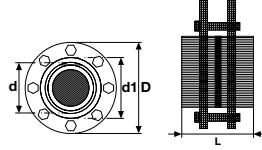

Düşük Dayanımlı Asit İçin  
For Low Strength Acid

Yüksek Dayanımlı Asit İçin  
For High Strength Acid

Çap Dia	Basınç PN	EPDM Conta Kod EPDM O-Ring Code	Fiyat (Adet) Price (Pcs)	FPM Conta Kod FPM O-Ring Code	Fiyat (Adet) Price (Pcs)	Kg /Adet Kg/Pcs	Koli/Ad. Box/Pcs	DN (mm)	D1 (mm)	D (mm)	L (mm)	nQe (mm)
63	10	428 00 063 2	38,00 €	428 03 063 2	49,40 €	1,83	8	50	77	165	90	4 x 16
75	10	428 00 075 2	42,00 €	428 03 075 2	54,60 €	2,31	4	65	90	185	110	4 x 16
90	10	428 00 090 2	48,00 €	428 03 090 2	62,40 €	3,75	4	80	107	200	126	8 x 16
110	10	428 00 110 2	58,00 €	428 03 110 2	62,40 €	4,35	4	100	129	220	155	8 x 16
125	10	428 00 125 2	63,00 €	428 03 125 2	81,90 €	5,35	2	100	147	250	173	8 x 16
140	10	428 00 140 2	73,00 €	428 03 140 2	95,00 €	5,87	2	125	164	250	182	8 x 16
160	10	428 00 160 2	83,00 €	428 03 160 2	108,00 €	7,03	2	150	188	285	209	8 x 20
200	10	428 00 200 2	124,00 €	428 03 200 2	161,00 €	10,0	1	200	230	340	253	8 x 20
225	10	428 00 225 2	144,00 €	428 03 225 2	187,00 €	10,5	1	200	245	340	285	8 x 20
250	10	428 00 250 2	304,00 €	428 03 250 2	395,00 €	16,2	1	250	269	395	375	12 x 20
280	10	428 00 280 2	378,00 €	428 03 280 2	491,00 €	15,5	1	250	304	395	375	12 x 20
315	10	428 00 315 2	531,00 €	428 03 315 2	690,00 €	19,8	1	300	341	445	415	12 x 20
400	10	428 00 400 2	1,200,00 €	428 03 400 2	1,560,00 €		1	400	450	565	482	16 x 24



### PP Flanşlı Kelebek Vana Takım (304 Paslanmaz Cıvata, Somun, Pul) PP Butterfly Valve With Flange (304 S.S. Screw, Nut, Washer)

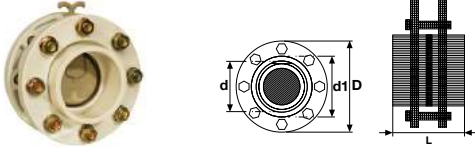

Düşük Dayanımlı Asit İçin  
For Low Strength Acid

Yüksek Dayanımlı Asit İçin  
For High Strength Acid

Çap Dia	Basınç PN	EPDM Conta Kod EPDM O-Ring Code	Fiyat (Adet) Price (Pcs)	FPM Conta Kod FPM O-Ring Code	Fiyat (Adet) Price (Pcs)	Kg /Adet Kg/Pcs	Koli/Ad. Box/Pcs	DN (mm)	D1 (mm)	D (mm)	L (mm)	nQe (mm)
63	10	428 04 063 2	53,20 €	428 05 063 2	63,84 €	3,10	8	50	77	165	90	4 x 16
75	10	428 04 075 2	58,80 €	428 05 075 2	70,56 €	3,40	4	65	90	185	110	4 x 16
90	10	428 04 090 2	67,20 €	428 05 090 2	80,64 €	3,71	4	80	107	200	126	8 x 16
110	10	428 04 110 2	81,20 €	428 05 110 2	97,44 €	4,56	4	100	129	220	155	8 x 16
125	10	428 04 125 2	88,20 €	428 05 125 2	105,84 €	5,55	2	100	147	250	173	8 x 16
140	10	428 04 140 2	102,20 €	428 05 140 2	122,64 €	5,77	2	125	164	250	182	8 x 16
160	10	428 04 160 2	116,20 €	428 05 160 2	139,44 €	7,47	2	150	188	285	209	8 x 20
200	10	428 04 200 2	173,60 €	428 05 200 2	208,32 €	10,0	1	200	230	340	253	8 x 20
225	10	428 04 225 2	201,60 €	428 05 225 2	241,92 €	10,1	1	200	245	340	285	8 x 20
250	10	428 04 250 2	425,60 €	428 05 250 2	510,72 €	20,6	1	250	269	395	375	12 x 20
280	10	428 04 280 2	529,20 €	428 05 280 2	635,04 €	20,5	1	250	304	395	375	12 x 20
315	10	428 04 315 2	742,40 €	428 05 315 2	892,08 €	25,1	1	300	341	445	415	12 x 20
400	10	428 04 400 2	1,680,00 €	428 05 400 2	2,016,00 €		1	400	450	565	482	16 x 24

### PP Flanşlı Kelebek Vana Takım (316 Paslanmaz Cıvata, Somun, Pul) PP Butterfly Valve With Flange (316 S.S. Screw, Nut, Washer)

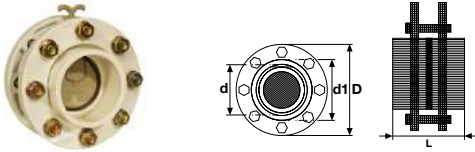

Düşük Dayanımlı Asit İçin  
For Low Strength Acid

Yüksek Dayanımlı Asit İçin  
For High Strength Acid

Çap Dia	Basınç PN	EPDM Conta Kod EPDM O-Ring Code	Fiyat (Adet) Price (Pcs)	FPM Conta Kod FPM O-Ring Code	Fiyat (Adet) Price (Pcs)	Kg /Adet Kg/Pcs	Koli/Ad. Box/Pcs	DN (mm)	D1 (mm)	D (mm)	L (mm)	nQe (mm)
63	10	428 06 063 2	74,48 €	428 07 063 2	89,38 €	3,10	8	50	77	165	90	4 x 16
75	10	428 06 075 2	82,32 €	428 07 075 2	98,78 €	3,40	4	65	90	185	110	4 x 16
90	10	428 06 090 2	94,08 €	428 07 090 2	112,90 €	3,71	4	80	107	200	126	8 x 16
110	10	428 06 110 2	113,68 €	428 07 110 2	136,42 €	4,56	4	100	129	220	155	8 x 16
125	10	428 06 125 2	123,48 €	428 07 125 2	148,18 €	5,55	2	100	147	250	173	8 x 16
140	10	428 06 140 2	143,08 €	428 07 140 2	171,70 €	5,77	2	125	164	250	182	8 x 16
160	10	428 06 160 2	162,68 €	428 07 160 2	195,22 €	7,47	2	150	188	285	209	8 x 20
200	10	428 06 200 2	243,04 €	428 07 200 2	291,65 €	10,0	1	200	230	340	253	8 x 20
225	10	428 06 225 2	282,24 €	428 07 225 2	338,69 €	10,1	1	200	245	340	285	8 x 20
250	10	428 06 250 2	595,84 €	428 07 250 2	715,00 €	20,6	1	250	269	395	375	12 x 20
280	10	428 06 280 2	740,88 €	428 07 280 2	889,06 €	20,5	1	250	304	395	375	12 x 20
315	10	428 06 315 2	1,040,76 €	428 07 315 2	1,248,91 €	25,1	1	300	341	445	415	12 x 20
400	10	428 06 400 2	2,352,00 €	428 07 400 2	2,822,40 €		1	400	450	565	482	16 x 24



**PP Kole**  
PP Flange Adaptor

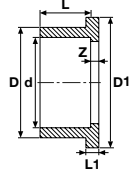

d mm	Basınç PN	Kod Code	Fiyat (Adet) Price (Pcs)	Kg /Adet Kg/Pcs	Koli/Adet Box/Pcs	DN1 (mm)	D (mm)	D1 (mm)	L (mm)	L1 (mm)	Z (mm)
20	10	512 03 020 2	0,66 €	0,009	750	15	27	34,0	16,0	7	3
25	10	512 03 025 2	0,66 €	0,01	450	20	33	41,0	19,0	7	3
32	10	512 03 032 2	0,84 €	0,02	250	25	41	50,0	22,0	7	3
40	10	512 03 040 2	0,95 €	0,04	150	32	50	61,0	26,0	8	3
50	10	512 03 050 2	0,95 €	0,06	160	40	60	73,0	31,0	8	3
63	10	512 03 063 2	0,97 €	0,09	100	50	77	91,0	38,0	9	3
75	10	512 03 075 2	1,20 €	0,16	70	65	90	106,0	43,5	10	3
90	10	512 03 090 2	1,56 €	0,23	85	80	107	125,0	51,0	11	5
110	10	512 03 110 2	2,48 €	0,41	45	100	129	150,0	61,0	12	5
125	10	512 03 125 2	3,30 €	0,60	24	110	147	170,0	69,0	13	5
140	10	512 03 140 2	4,32 €	0,78	18	125	164	188,0	76,0	14	5
160	10	512 03 160 2	6,34 €	1,10	16	150	188	213,0	86,0	16	5

○ ● ● ● Beyaz ürün harici diğer renklerde minimum adet için lütfen sorunuz.

**PP İç Dişli Kole**  
PP Female Threaded Flange Adaptor

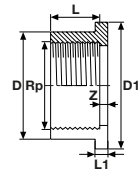

Rp Inch	Basınç PN	Kod Code	Fiyat (Adet) Price (Pcs)	Kg /Adet Kg/Pcs	Koli/Adet Box/Pcs	DN (mm)	D (mm)	D1 (mm)	L (mm)	L1 (mm)	Z (mm)
1/2"	10	512 04 020 2	1,14 €	0,01	750	15	27	34,0	16,0	7	3
3/4"	10	512 04 025 2	1,38 €	0,01	450	20	33	41,0	19,0	7	3
1"	10	512 04 032 2	1,62 €	0,02	250	25	41	50,0	22,0	7	3
1 1/4"	10	512 04 040 2	1,86 €	0,03	150	32	50	61,0	26,0	8	3
1 1/2"	10	512 04 050 2	2,40 €	0,07	160	40	60	73,0	35,0	8	3
2"	10	512 04 063 2	2,70 €	0,13	100	50	77	91,0	38,0	9	3
2 1/2"	10	512 04 075 2	4,74 €	0,12	60	65	90	106,0	43,0	10	3
3"	10	512 04 090 2	5,22 €	0,27	85	80	107	125,0	51,0	11	5
4"	10	512 04 110 2	6,00 €	0,35	45	100	129	150,0	60,0	12	5

○ ● ● ● Beyaz ürün harici diğer renklerde minimum adet için lütfen sorunuz.

**PP Tamir Flanş**  
PP Repair Flange

NEW

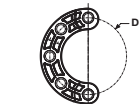

d (mm)	Basınç PN	Kod Code	Fiyat (€/Adet) Price (€/Pcs)	Kg /Adet Kg/Pcs	Koli/Adet Box/Pcs	D1 (mm)	D2 (mm)	D3 (mm)	H (mm)
90	10	513 06 090 2	4,56 €		35	160	200	18	20
110	10	513 06 110 2	4,85 €		22	180	220	18	22
125	10	513 06 125 2	6,44 €	0,615	18	210	250	18,5	25
140	10	513 06 140 2	6,36 €	0,560	18	210	250	18	25,5
160	10	513 06 160 2	8,55 €	0,600	14	240	285	22	28
200	10	513 06 200 2	16,49 €	1,130	11	295	340	22	30

○ ● ● ● Beyaz ürün harici diğer renklerde minimum adet için lütfen sorunuz.

## PP Flanş

### PP Flange

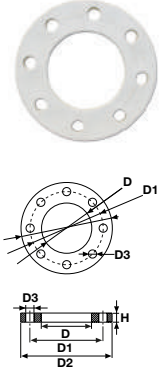

d mm	Basınç PN	Kod Code	Fiyat (Adet) Price (Pcs)	Kg /Adet Kg/Pcs	Koli/Adet Box/Pcs	DN (mm)	D (mm)	D1 (mm)	D2 (mm)	D3 (mm)	H (mm)	N (Adet)
20	10	513 01 020 2	1,38 €	0,10	150	15	28	65	96	14	11	4
25	10	513 01 025 2	1,38 €	0,12	100	20	34	75	105	14	12	4
32	10	513 01 032 2	1,56 €	0,18	80	25	42	85	115	14	14	4
40	10	513 01 040 2	1,80 €	0,29	50	32	51	100	140	14	15	4
50	10	513 01 050 2	1,80 €	0,29	48	40	62	110	150	18	16	4
63	10	513 01 063 2	1,98 €	0,30	25	50	78	125	165	18	18	4
75	10	513 01 075 2	2,58 €	0,40	40	65	92	145	185	18	20	4
90	10	513 01 090 2	2,88 €	0,46	35	80	111	160	200	18	22	8
110	10	513 01 110 2	3,06 €	0,53	22	100	133	180	220	18	24	8
125	10	513 01 125 2	4,07 €	0,78	18	110	150	210	250	18	26	8
140	10	513 01 140 2	4,02 €	0,74	18	125	167	210	250	18	26	8
160	10	513 01 160 2	5,40 €	0,81	14	150	193	250	285	22	28	8
200	10	513 01 200 2	10,41 €	1,67	8	175	234	295	340	22	32	8
225	10	513 01 225 2	10,41 €	1,82	8	200	257	295	340	22	32	8
250	10	513 01 250 2	50,40 €	2,19	7	250	278	325	370	22	36	8
280	10	513 01 280 2	51,15 €	2,32	7	250	310	350	395	22	36	12
315	10	513 01 315 2	51,15 €	2,96	7	300	348	400	445	22	36	12
355	10	513 01 355 2	156,00 €		1	350	388	460	505	22	38	16
400	10	513 01 400 2	210,00 €		1	400	442	515	565	26	42	16

○ ● ● ● Beyaz ürün harici diğer renklerde minimum adet için lütfen sorunuz.

## PP Kör Flanş

### PP Blind Flange

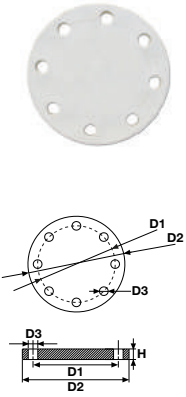

d mm	Basınç PN	Kod Code	Fiyat (Adet) Price (Pcs)	Kg /Adet Kg/Pcs	Koli/Adet Box/Pcs	DN (mm)	D1 (mm)	D2 (mm)	D3 (mm)	H (mm)	N (Adet)
20	10	514 01 020 2	3,59 €	0,09	150	15	65	96	14	12	4
25	10	514 01 025 2	4,30 €	0,14	110	20	75	105	14	13	4
32	10	514 01 032 2	5,03 €	0,17	80	25	85	115	14	15	4
40	10	514 01 040 2	5,75 €	0,28	50	32	100	140	14	16	4
50	10	514 01 050 2	6,95 €	0,37	48	40	110	150	18	17	4
63	10	514 01 063 2	7,67 €	0,57	25	50	125	165	18	20	4
75	10	514 01 075 2	8,63 €		40	65	145	185	18	21	4
90	10	514 01 090 2	9,35 €		35	80	160	200	18	22	8
110	10	514 01 110 2	9,00 €		22	100	180	220	18	24	8
125	10	514 01 125 2	11,58 €	1,628	18	125	210	250	18	28	8
140	10	514 01 140 2	11,58 €	1,628	18	125	210	250	18	28	8
160	10	514 01 160 2	16,20 €	2,586	18	150	250	285	22	28	8
200	10	514 01 200 2	43,20 €	3,82	14	200	295	340	22	32	8
225	10	514 01 225 2	43,20 €	3,82	8	200	295	340	22	32	8
250	10	514 01 250 2	90,00 €		8	250	350	395	22	36	8
280	10	514 01 280 2	90,00 €		8	250	350	395	22	36	12
315	10	514 01 315 2	113,88 €		7	300	400	445	22	36	12
355	10	514 01 355 2	210,00 €		7	350	460	505	22	38	16
400	10	514 01 400 2	221,00 €		7	400	515	565	26	40	16

○ ● ● ● Beyaz ürün harici diğer renklerde minimum adet için lütfen sorunuz.



**PPR Boru 20 ATÜ (S 2,5)(L=4 Mt.)**

PPR Pipe PN 20 (S 2,5) (L=4Mt.)

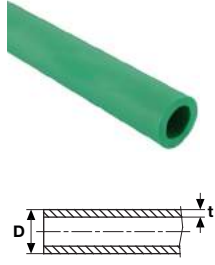

Çap Dia	Kod Code	Fiyat (Adet) Price (Pcs)	Kg /Adet Kg/Pcs	Koli/Adet Box/Pcs	Mt.
20	800 00 020 2	0,91 €		25	100
25	800 00 025 2	1,52 €		20	80
32	800 00 032 2	2,78 €		10	40
40	800 00 040 2	4,55 €		5	20
50	800 00 050 2	7,55 €		5	20
63	800 00 063 2	11,62 €		3	12
75	800 00 075 2	17,99 €		2	8
90	800 00 090 2	29,48 €		2	8
110	800 00 110 2	43,32 €		1	4
125	800 00 125 2	58,93 €		1	4
160	800 00 160 2	84,28 €		1	4
200	800 00 200 2	119,04 €		1	4

**PPR-CET Kompozit Boru 20 ATÜ (S5)(L=4 Mt.)**

PPR Composite Pipe PN 20 (S5) (L=4Mt.)

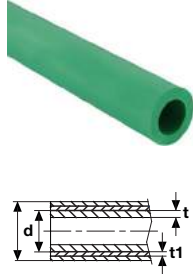

Çap Dia	Kod Code	Fiyat (Adet) Price (Pcs)	Kg /Adet Kg/Pcs	Koli/Adet Box/Pcs	Mt.
20	800 01 020 2	1,33 €		25	100
25	800 01 025 2	1,94 €		20	80
32	800 01 032 2	3,33 €		10	40
40	800 01 040 2	5,47 €		5	20
50	800 01 050 2	8,68 €		5	20
63	800 01 063 2	13,85 €		3	12
75	800 01 075 2	20,61 €		2	8
90	800 01 090 2	28,92 €		2	8
110	800 01 110 2	43,08 €		1	4

**ALF PPR Alüminyum Folyolu Boru 20 ATÜ (L=4 Mt.)**

PPR Aluminium Pipes PN 20 (L=4Mt.)

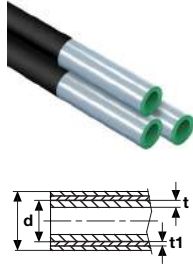

Çap Dia	Kod Code	Fiyat (Adet) Price (Pcs)	Kg /Adet Kg/Pcs	Koli/Adet Box/Pcs	Mt.
20	800 02 020 2	1,65 €		20	80
25	800 02 025 2	2,33 €		15	60
32	800 02 032 2	4,15 €		10	40
40	800 02 040 2	6,81 €		5	20
50	800 02 050 2	12,15 €		5	20
63	800 02 063 2	16,21 €		3	12
75	800 02 075 2	23,23 €		2	8
90	800 02 090 2	36,38 €		2	8
110	800 02 110 2	54,56 €		1	4

**PP-PCT Plus (S4) (L=4Mt.)**

PPR Composite Pipe (S4) (L=4Mt.)

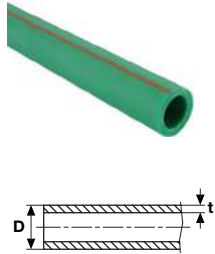

Çap Dia	Kod Code	Fiyat (Adet) Price (Pcs)	Kg /Adet Kg/Pcs	Koli/Adet Box/Pcs	Mt.
20	800 03 020 2	0,91 €		25	100
25	800 03 025 2	1,52 €		20	80
32	800 03 032 2	2,78 €		10	40
40	800 03 040 2	4,55 €		5	20
50	800 03 050 2	7,55 €		5	20
63	800 03 063 2	11,62 €		3	12
75	800 03 075 2	17,99 €		2	8
90	800 03 090 2	29,48 €		2	8
110	800 03 110 2	43,32 €		1	4
125	800 03 125 2	58,93 €		1	4
160	800 03 160 2	84,28 €		1	4
200	800 03 200 2	119,04 €		1	4

### PPR-BET Bazalt Borular (L=4 Mt.)

PPR Pipe PN 20 (L=4Mt.)

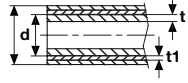

Çap Dia	Kod Code	Fiyat (Adet) Price (Pcs)	Kg /Adet Kg/Pcs	Koli/Adet Box/Pcs	Mt.
20	800 04 020 2	1,41 €		25	100
25	800 04 025 2	2,04 €		20	80
32	800 04 032 2	3,54 €		10	40
40	800 04 040 2	5,95 €		5	20
50	800 04 050 2	9,43 €		5	20
63	800 04 063 2	15,06 €		3	12
75	800 04 075 2	22,41 €		2	8
90	800 04 090 2	32,01 €		2	8
110	800 04 110 2	47,67 €		1	4
125	800 04 125 2	69,54 €		1	4

### PPR Kelepçe (Klips)

PPR Clamp

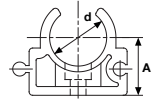

Çap Dia	Basınç PN	Kod Code	Fiyat (Adet) Price (Pcs)	Kg /Adet Kg/Pcs	Koli/Adet Box/Pcs	A (mm)
20	16	802 40 020	0,07 €		1200	19,5
25	16	802 40 025	0,11 €		960	22
32	16	802 40 032	0,14 €		500	25
40	16	802 40 040	0,34 €		320	29
50	16	802 40 050	0,52 €		200	44
20	16	802 50 020	0,26 €		500	31,5
25	16	802 50 025	0,31 €		320	36,5
32	16	802 50 032	0,58 €		200	47
20	16	802 60 020	0,46 €		1120	
25	16	802 60 025	0,47 €		840	24,5
32	16	802 60 032	0,54 €		480	32,5

### PPR Yapıştırma Dirsek (45°)

PPR Paste Elbow (45°)

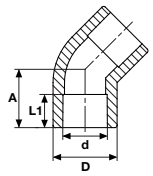

Çap Dia	Basınç PN	Kod Code	Fiyat (Adet) Price (Pcs)	Kg /Adet Kg/Pcs	Koli/Adet Box/Pcs	D (mm)	A (mm)	L1(min.) (mm)
20	16	800 06 020 2	0,17 €		450	26,5	20	14,5
25	16	800 06 025 2	0,24 €		300	33,5	22	16
32	16	800 06 032 2	0,40 €		150	43,5	32	18
40	16	800 06 040 2	1,19 €		80	54,5	31	20,5
50	16	800 06 050 2	1,62 €		40	67,5	35	23,5
63	16	800 06 063 2	2,95 €		25	84	42,5	27,5
75	16	800 06 075 2	4,29 €		15	100	47	30
90	16	800 06 090 2	16,24 €		8	92	166	33
110	16	800 06 110 2	20,12 €		4	111,5	162	37

### PPR Yapıştırma Dirsek (90°)

PPR Paste Elbow (90°)

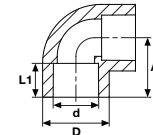

Çap Dia	Basınç PN	Kod Code	Fiyat (Adet) Price (Pcs)	Kg /Adet Kg/Pcs	Koli/Adet Box/Pcs	D (mm)	A (mm)	L1(min.) (mm)
20	16	800 07 020 2	0,12 €		400	28	25,5	14,5
25	16	800 07 025 2	0,20 €		250	33	29,5	16
32	16	800 07 032 2	0,35 €		120	42,5	35	18
40	16	800 07 040 2	0,67 €		100	53	41,5	20,5
50	16	800 07 050 2	1,34 €		48	67	49,5	23,5
63	16	800 07 063 2	2,56 €		24	83,5	58,5	27,5
75	16	800 07 075 2	4,11 €		18	101,5	67,5	30
90	16	800 07 090 2	9,44 €		5	121	78,5	33
110	16	800 07 110 2	15,22 €		5	147	92,5	37
125	16	800 07 125 2	28,81 €		5	168	102	40



**PPR Kuyruklu Yapıştırma Dirsek (45°-90°)**  
PPR Tailed Elbow (45°- 90°)

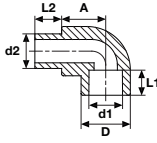

Çap Dia	Basınç PN	Kod Code	Fiyat (Adet) Price (Pcs)	Kg /Adet Kg/Pcs	Koli/Adet Box/Pcs	d1 (mm)	L1 min (mm)	d2 (mm)	L2 min (mm)	D (mm)	A (mm)
20-90	16	800 08 020 2	0,24 €		500	19,5	14,5	11	11	28,5	25
25-90	16	800 08 025 2	0,35 €		300	24,5	16	12,5	12,5	33,5	29,5
25/20-90	16	800 08 2520 2	0,80 €		300	24,5	16	11	11	33	29
20-45	16	800 08 2045 2	0,75 €		300	19,5	14,5	20	11	28	19,5

**PPR Açık Dirsek**  
PPR Open Elbow

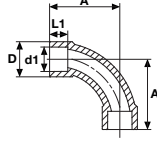

Çap Dia	Basınç PN	Kod Code	Fiyat (Adet) Price (Pcs)	Kg /Adet Kg/Pcs	Koli/Adet Box/Pcs	L1 min (mm)	d2 (mm)	L2 min (mm)	D (mm)
20	16	800 09 020 2	0,44 €		500	14,5	28	56	52

**PPR Redüksiyon Dirsek**  
PPR Reduction Elbow

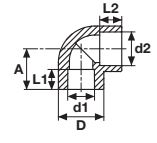

Çap Dia	Basınç PN	Kod Code	Fiyat (Adet) Price (Pcs)	Kg /Adet Kg/Pcs	Koli/Adet Box/Pcs	L1 min (mm)	d2 (mm)	L2 min (mm)	D (mm)	A (mm)
20-25	16	800 09 2025 2	0,34 €		300	14,5	25	12,5	33	29,5

**PPR İçten Dişli Dirsek**  
PPR Female Threaded Elbow

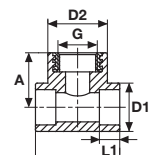

Çap Dia	Basınç PN	Kod Code	Fiyat (Adet) Price (Pcs)	Kg /Adet Kg/Pcs	Koli/Adet Box/Pcs	L1(min.) (mm)	D1 (mm)	D2 (mm)	A1 (mm)	A2 (mm)
20x1/2"	16	803 30 020	1,11 €		250	14,5	28,5	38,5	31,5	35,5
25x1/2"	16	803 30 025	1,22 €		160	16	33,5	39	32,5	38
25x3/4"	16	803 30 025	1,70 €		180	16	34	43	32	39,5
32x1"	16	803 30 032	3,53 €		100	18	43,5	54	34	45

**PPR Dıştan Dişli Dirsek**  
PPR Male Threaded Elbow

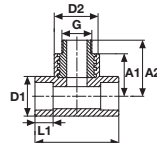

Çap Dia	Basınç PN	Kod Code	Fiyat (Adet) Price (Pcs)	Kg /Adet Kg/Pcs	Koli/Adet Box/Pcs	L1(min.) (mm)	D1 (mm)	D2 (mm)	A1 (mm)	A2 (mm)	A3 (mm)
20x1/2"	16	803 40 020	1,60 €		200	14,5	28	39	30,5	39,5	52,5
20x3/4"	16	803 40 020	2,18 €		180	14,5	29	40	30,5	39	52
25x1/2"	16	803 40 025	1,83 €		160	16	33	38,5	32	38	51
25x3/4"	16	803 40 025	2,21 €		140	16	34	43	32	40	53
32 x 1"	16	803 40 032	4,59 €		80	18	43,5	54	34,5	45	60
32x3/4"	16	803 40 032	3,56 €		80	18	43,5	57	34,5	44	52

**PPR Açık Dirsek**  
PPR Long Elbow

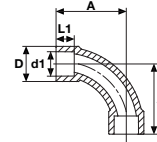

Çap Dia	Basınç PN	Kod Code	Fiyat (Adet) Price (Pcs)	Kg /Adet Kg/Pcs	Koli/Adet Box/Pcs
25x1/2"	16	803 50 025	1,93 €		300

**PPR Hareketli Dirsek**  
PPR Moving Elbow

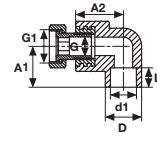

Çap Dia	Basınç PN	Kod Code	Fiyat (Adet) Price (Pcs)	Kg /Adet Kg/Pcs	Koli/Adet Box/Pcs	L1 min (mm)	D1 (mm)	A1 (mm)	A2 (mm)	G (mm)	G1 (mm)
20x1/2"	16	805 40 020	4,65 €		100	14,5	28	31	36	1/2"	1/2"
25x3/4"	16	805 40 025	5,19 €		100	16	33	32,5	38,5	1/2"	3/4"

## PPR Yapıştırma Te

### PPR Pasting Tee

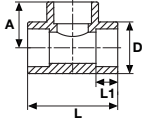

Çap Dia	Basınç PN	Kod Code	Fiyat (Adet) Price (Pcs)	Kg /Adet Kg/Pcs	Koli/Adet Box/Pcs	L1 min (mm)	D (mm)	L (mm)	A (mm)
20	16	801 00 020	0,18 €		240	20	27	51,5	26,5
25	16	801 00 025	0,25 €		150	25	33	63	29,5
32	16	801 00 032	0,58 €		90	32	43,5	70	34,5
40	16	801 00 040	1,36 €		50	40	53	85	43,5
50	16	801 00 050	1,75 €		32	50	65,5	103	55
63	16	801 00 063	4,21 €		18	63	84,5	120	58
75	16	801 00 075	5,66 €		12	75	100,5	139	70
90	16	801 00 090	11,65 €		6	90	121,0	158	79,5
110	16	801 00 110	19,36 €		4	110	147,5	185,5	92
125	16	801 00 125	22,22 €		4	125	167	208	103,5

## PPR İnegal Te

### PPR Reducing Tee

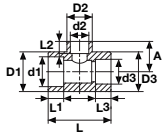

Çap Dia	Basınç PN	Kod Code	Fiyat (Adet) Price (Pcs)	Kg /Adet Kg/Pcs	Koli/Adet Box/Pcs	L1(min.) (mm)	L2(min.) (mm)	D1 (mm)	D2 (mm)	D3 (mm)	L (mm)	A (mm)
20x25x20	16	801 01 202520	0,73 €		150	14,5	16	33	33,5	33	65	35,5
25x20x20	16	801 01 252020	0,63 €		150	16	14,5	35	28	28	53	27,5
25x20x25	16	801 01 252025	0,45 €		150	16	14,5	33	26,5	33	55	28,5
25x25x20	16	801 01 252520	0,69 €		150	16	16	33,5	33,5	33,5	65	36
32x20x20	16	801 01 322020	1,04 €		90	18	14,5	42,5	42,5	42,5	73	41
32x20x25	16	801 01 322025	0,86 €		90	18	14,5	42,5	28	33,5	62	29,5
32x20x32	16	801 01 322032	0,72 €		90	18	14,5	42,5	27	42,5	60,5	31,5
32x25x20	16	801 01 322520	1,00 €		90	18	16	42,5	42,5	42,5	73	41
32x25x25	16	801 01 322525	1,00 €		90	18	16	43	43	43	73,5	40
32x25x32	16	801 01 322532	1,72 €		90	18	16	43	34	43	66	34,5
32x50x32	16	801 01 325032	2,25 €		32	18	23,5	65	65	65	103	54,5
40x20x40	16	801 01 402040	0,95 €		50	20,5	14,5	53	28	53	65,5	38,5
40x25x40	16	801 01 402540	1,24 €		50	20,5	16	53	33,5	53	70,5	40
40x32x40	16	801 01 403240	2,13 €		50	20,5	18	52,5	43	52,5	80	41
40x50x40	16	801 01 405040	2,10 €		32	20,5	23,5	65	65	65	103	54,5
50x32x40	16	801 01 503240	2,01 €		32	23,5	18	66	65,5	66	103	54,5
50x40x32	16	801 01 504032	2,01 €		32	23,5	20,5	65	65	65	103	54,5
50x32x32	16	801 01 503232	2,01 €		32	23,5	18	65,5	65,5	65,5	103	55,5
50x40x40	16	801 01 504040	1,93 €		32	23,5	20,5	66	65,5	66	104	55,5
50x32x50	16	801 01 503250	1,93 €		32	23,5	18	65	51	65	90	49,5
50x40x50	16	801 01 504050	1,93 €		32	23,5	20,5	65	51	65	90	48,5
50x50x32	16	801 01 505032	1,93 €		32	23,5	23,5	66	66,5	66	103,5	55
50x50x40	16	801 01 505040	1,93 €		32	23,5	23,5	65	65	65	103	54,5
50x20x50	16	801 01 502050	1,82 €		32	23,5	14,5	65	34	65	90	43,5
50x25x50	16	801 01 502550	1,82 €		32	23,5	16	65	34	65	90	43,5
63x20x63	16	801 01 632063	3,28 €		20	27,5	14,5	84	43	84	90	52
63x25x63	16	801 01 632563	3,28 €		20	27,5	16	84	43	84	91	52
63x32x63	16	801 01 633263	3,28 €		20	27,5	18	84	43,5	84	91,5	52,5
63x40x63	16	801 01 634063	3,41 €		20	27,5	20,5	84	52	84	126,5	62
63x50x63	16	801 01 635063	3,41 €		20	27,5	23,5	84	66	84	125,5	58,5
75x20x75	16	801 01 752075	7,20 €		12	30	14,5	101	52	101	160	60
75x25x75	16	801 01 752575	7,20 €		12	30	16	101	52	101	160	60
75x32x75	16	801 01 753275	7,20 €		12	30	18	101	52	101	160	61
75x40x75	16	801 01 754075	7,20 €		12	30	20,5	101	52	101	160	61
75x50x75	16	801 01 755075	7,20 €		12	30	23,5	101	84,5	101	160	69
75x63x75	16	801 01 756375	7,20 €		12	30	27,5	101	84,5	101	160	67,5
90x75x90	16	801 01 907590	11,92 €		8	33	30	120	120	120	157,5	74
110x90x110	16	801 01 11090110	20,31 €		4	37	33	146	146	146	185	93



**PPR İstavroz "TE"**  
PPR Cross "TEE"

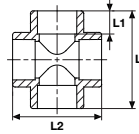

Çap Dia	Basınç Pn	Kod Code	Fiyat (Adet) Price (Pcs)	Koli/Ad. Box/Pcs	L1 min (mm)	D (mm)	L (mm)	L2 (mm)
20	16	801 02 020 2	0,57 €	200	14,5	27	51	51
25	16	801 02 025 2	0,66 €	150	16	33,5	60	60
32	16	801 02 032 2	1,09 €	90	18	43,5	70	70
40	16	801 02 040 2	2,81 €	50	20,5	53	85	85
50	16	801 02 050 2	3,97 €	24	23,5	69	103,5	103,5

**PPR İçten Dişli "TE"**  
PPR Internal Gear "TEE"

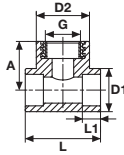

Çap Dia	Basınç Pn	Kod Code	Fiyat (Adet) Price (Pcs)	Koli/Ad. Box/Pcs	L1 min (mm)	D1 (mm)	D2 (mm)	A (mm)	L (mm)	G (mm)
20x1/2"	16	804 60 020	1,22 €	200	14,5	27	38,5	35	51,5	1/2"
20x3/4"	16	804 61 020	1,69 €	140	14,5	28,5	43	36	60,5	3/4"
25x1/2"	16	804 60 025	1,42 €	120	16	33	38	37	60	1/2"
25x3/4"	16	804 61 025	1,76 €	120	16	35	43,5	37	59,5	3/4"
32x1"	16	804 60 032	3,64 €	70	18	43,5	53,5	43	70	1"

**PPR Dıştan Dişli "TE"**  
PPR Male Threaded "TEE"

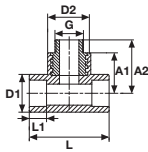

Çap Dia	Basınç Pn	Kod Code	Fiyat (Adet) Price (Pcs)	Koli/Ad. Box/Pcs	L1 min (mm)	D1 (mm)	D2 (mm)	A1 (mm)	A2 (mm)	L (mm)	G (mm)
20x1/2"	16	804 60 020	1,22 €	200	14,5	27	38,5	34,5	47,5	51,5	1/2"
20x3/4"	16	804 61 020	1,69 €	140	14,5	28,5	43,5	36,5	49,5	60,5	3/4"
25x1/2"	16	804 60 025	1,42 €	120	16	33	38	37,5	50,5	60	1/2"
25x3/4"	16	804 61 025	1,76 €	120	16	35	43	36,5	49,5	59,5	3/4"
32x1"	16	804 60 032	3,64 €	70	18	43	53,5	48	63	73,5	1"

**PPR Yapıştırma Manşon**  
PPR Adhesive Sleeve

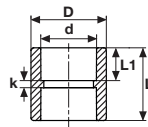

Çap Dia	Basınç Pn	Kod Code	Fiyat (Adet) Price (Pcs)	Koli/Ad. Box/Pcs	D (mm)	L (mm)	L1(min.) (mm)	k (mm)
20	16	800 05 020 2	0,10 €	600	28	34	14,5	4
25	16	800 05 025 2	0,14 €	400	34	37	16	4
32	16	800 05 032 2	0,29 €	240	42,5	41	18	4
40	16	800 05 040 2	0,44 €	120	53	46	20,5	4,5
50	16	800 05 050 2	0,77 €	100	67	51,5	23,5	4,5
63	16	800 05 063 2	1,91 €	48	83	60	27,5	5
75	16	800 05 075 2	2,53 €	30	100	65	30	5
90	16	800 05 090 2	6,46 €	24	120	72	33	6
110	16	800 05 110 2	9,21 €	10	146	80	37	11
125	16	800 05 125 2	12,31 €	10	167	86	40	6





### PPR Manşonlu Kavis (Köprü)

PPR Coupling Curve (Bridge)

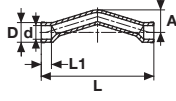

Çap Dia	Basınç Pn	Kod Code	Fiyat (Adet) Price (Pcs)	Koli/Ad. Box/Pcs	L1 min (mm)	D (mm)	L (mm)	A (mm)
20	16	801 08 020	0,51 €	150	14,5	28	160	33
25	16	801 08 025	0,76 €	100	16	33	197	38,5

### PPR Kısa Kavis

PPR Short Curve

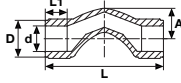

Çap Dia	Basınç Pn	Kod Code	Fiyat (Adet) Price (Pcs)	Koli/Ad. Box/Pcs	d (mm)	L1 min. (mm)	D (mm)	A (mm)	L (mm)
20	16	801 09 020	0,47 €	240	19,5	14,5	28	23	90
25	16	801 09 025	0,59 €	150	24,5	16	33,5	31	96

### PPR Kavis (Köprü)

PPR Arch (Bridge)



Çap Dia	Basınç Pn	Kod Code	Fiyat (Adet) Price (Pcs)	Koli/Ad. Box/Pcs	L (mm)
20	16	801 07 020	0,51 €	135	40
25	16	801 07 025	0,73 €	90	50
32	16	801 07 032	1,48 €	45	64
40	16	801 07 040	2,57 €	27	80

### PPR Branşman

PPR Branch



Çap Dia	Basınç Pn	Kod Code	Fiyat (Adet) Price (Pcs)	Koli/Ad. Box/Pcs
63/20	16	802 10 6320	0,99 €	600
63/25	16	802 10 6325	0,95 €	600
75/20	16	802 10 7520	0,99 €	600
75/25	16	802 10 7525	0,95 €	600
90/20	16	802 10 9020	0,99 €	600
90/25	16	802 10 9025	0,95 €	600
110/20	16	802 10 11020	0,99 €	600
110/25	16	802 10 11025	0,95 €	600

### PPR Fiyonk

PPR Bow

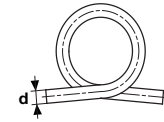

Çap Dia	Basınç Pn	Kod Code	Fiyat (Adet) Price (Pcs)	Koli/Ad. Box/Pcs
20	16	802 00 020	1,52 €	25
25	16	802 00 025	2,17 €	15
32	16	802 00 032	4,16 €	8
40	16	802 00 040	11,32 €	4

### PPR Hareketli Adaptör

PPR Moving Adapter

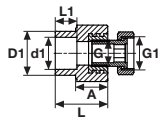

Çap Dia	Basınç Pn	Kod Code	Fiyat (Adet) Price (Pcs)	Koli/Ad. Box/Pcs	L1 min. (mm)	D1 (mm)	A1 (mm)	A2 (mm)	G (mm)	G1 (mm)
20x1/2"	16	805 60 020	5,52 €	120	14,5	28	31	36	1/2"	1/2"
25x3/4"	16	805 60 025	6,97 €	120	16	33	32,5	38,5	1/2"	3/4"



**PPR Hareketli Nipel**  
PPR Moving Nipple

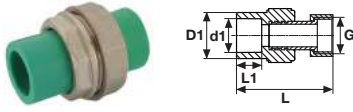

Çap Dia	Basınç Pn	Kod Code	Fiyat (Adet) Price (Pcs)	Koli/Ad. Box/Pcs
20x1/2"	16	805 80 020	2,50 €	300
20x3/4"	16	805 80 020	3,30 €	300
25x1/2"	16	805 80 025	3,93 €	300
25x3/4"	16	805 80 025	3,94 €	300

**PPR İçten Dişli Adaptör**  
PPR Female Threaded Adapter

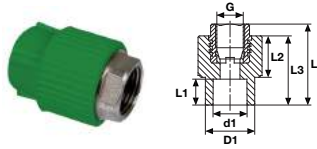

Çap Dia	Basınç Pn	Kod Code	Fiyat (Adet) Price (Pcs)	Koli/Ad. Box/Pcs	L1 min. (mm)	D1 (mm)	L2 (mm)	L3 (mm)	L (mm)	G (mm)
20x1/2"	16	805 00 020	1,88 €	120	14,5	33,5	23,5	39,5	50,5	1/2"
20x3/4"	16	805 00 020	3,14 €	100	14,5	33	23,5	40,5	50,5	3/4"
25x1/2"	16	805 00 025	1,88 €	100	16	38,5	23,5	40	48,5	1/2"
25x3/4"	16	805 00 025	3,14 €	100	16	38,5	23,5	40	50	3/4"
32x1"	16	805 00 032	4,71 €	60	18	47	30,5	50	61	1"
40x1 1/4"	16	805 00 040	7,78 €	40	20,5	54	25,5	47	61	1 1/4"
50x1 1/2"	16	805 00 050	11,29 €	24	23,5	68	29	53,5	67,5	1 1/2"
63x2"	16	805 00 063	16,37 €	14	27,5	84	30,5	59	77	2"
75x2 1/2"	16	805 00 075	25,98 €	12	30	93	29,5	59,5	78	2 1/2"
90x3"	16	805 00 090	54,89 €	5	33	120,5	44	75,5	92	3"
110x4"	16	805 00 110	78,55 €	4	37	147	48	84	102	4"

**PPR Dıştan Dişli Adaptör**  
PPR Male Threaded Adapter

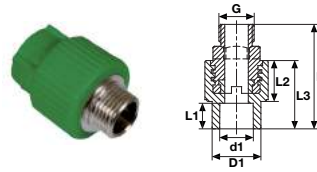

Çap Dia	Basınç Pn	Kod Code	Fiyat (Adet) Price (Pcs)	Koli/Ad. Box/Pcs	L1 min. (mm)	D1 (mm)	L2 (mm)	L3 (mm)	L (mm)	G (mm)
20x1/2"	16	800 10 020	3,33 €	100	14,5	33,5	23,5	39,5	61	1/2"
20x3/4"	16	800 10 020	4,97 €	80	14,5	33	23,5	40,5	64	3/4"
25x1/2"	16	800 10 025	3,39 €	80	16	38	23,5	40	62	1/2"
25x3/4"	16	800 10 025	4,97 €	80	16	39	23,5	40	63,5	3/4"
32x1"	16	800 10 032	6,92 €	40	18	47	30,5	50	77	1"
40x1 1/4"	16	800 10 040	9,56 €	25	20,5	54	25	47	81	1 1/4"
50x1 1/2"	16	800 10 050	12,59 €	16	23,5	67,5	29	53,5	87,5	1 1/2"
63x2"	16	800 10 063	19,40 €	10	27,5	79	31,5	56,5	99,5	2"
75x2 1/2"	16	800 10 075	29,64 €	6	30	92	33	59	105	2 1/2"
90x3"	16	800 10 090	74,96 €	5	33	120,5	43,5	76	118	3"
110x4"	16	800 10 110	116,27 €	3	37	147	48	84,5	129,5	4"

**PPR İçten Dişli Adaptör**  
PPR Female Threaded Adapter

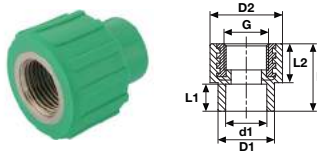

Çap Dia	Basınç Pn	Kod Code	Fiyat (Adet) Price (Pcs)	Koli/Ad. Box/Pcs	L1 min. (mm)	D1 (mm)	D2 (mm)	L2 (mm)	L (mm)	G (mm)
20x1/2"	16	803 00 020	1,03 €	320	14,5	28,5	38,5	24	40,5	1/2"
20x3/4"	16	803 00 020	1,69 €	240	14,5	29	42,5	24	40	3/4"
25x1/2"	16	803 00 025	1,19 €	250	16	33,5	38	24	40,5	1/2"
25x3/4"	16	803 00 025	1,49 €	280	16	33	42,5	24	40,5	3/4"
32x3/4"	16	803 00 032	2,17 €	120	18	43	53	28	47,5	1"
32x1"	16	803 00 032	3,42 €	120	18	43	45,5	24,5	44	3/4"

**PPR Dıştan Dişli Adaptör**  
PPR Male Threaded Adapter

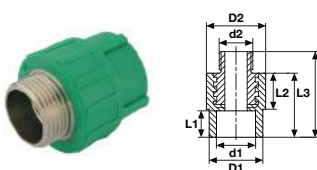

Çap Dia	Basınç Pn	Kod Code	Fiyat (Adet) Price (Pcs)	Koli/Ad. Box/Pcs	L1 min. (mm)	D1 (mm)	D2 (mm)	L (mm)	L2 (mm)	L3 (mm)	G (mm)
20x1/2"	16	803 10 020	1,47 €	200	14,5	28,5	35	53	24	40	1/2"
20x3/4"	16	803 10 020	2,11 €	140	14,5	29	42,5	53	23,5	40	3/4"
25x1/2"	16	803 10 025	1,55 €	120	16	34	39	53	23,5	40	1/2"
25x3/4"	16	803 10 025	1,98 €	120	16	33	42	53	24	40	3/4"
32x3/4"	16	803 10 032			18	43	45	57	24,5	44	3/4"
32x1"	16	803 10 032	2,77 €	70	18	43	52,5	62,5	28	47	1"

### PPR İçten Dişli Redüksiyon

PPR Female Threaded Reducer

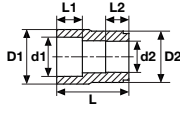

Çap Dia	Basınç Pn	Kod Code	Fiyat (Adet) Price (Pcs)	Koli/Ad. Box/Pcs	L1(min.) (mm)	L2(min.) (mm)	D1 (mm)	D2 (mm)	L (mm)
25/20	16	801 04 2520	0,41 €	300	16	11	34,5	32,5	45,5
32/25	16	801 04 3225	0,55 €	250	18	12,5	43,5	41	51

### PPR Redüksiyon

PPR Reducer

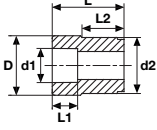

Çap Dia	Basınç Pn	Kod Code	Fiyat (Adet) Price (Pcs)	Koli/Ad. Box/Pcs	L1(min.) (mm)	L2(min.) (mm)	D (mm)	L (mm)
25x20	16	801 03 2520	0,14 €	560	14,5	12,5	30	39,5
32x20	16	801 03 3220	0,29 €	300	14,5	14,5	34,5	39
32x25	16	801 03 3225	0,29 €	300	16	14,5	35	39,5
40x20	16	801 03 4020	0,29 €	240	14,5	17	41	47,5
40x25	16	801 03 4025	0,31 €	240	16	17	41	48
40x32	16	801 03 4032	0,38 €	200	18	17	43	46
50x20	16	801 03 5020	0,64 €	200	14,5	20	51	48
50x25	16	801 03 5025	0,78 €	200	16	20	51	49,5
50x32	16	801 03 5032	0,74 €	150	18	20	50,5	47,5
50x40	16	801 03 5040	0,77 €	120	20,5	20	53,5	48
63x25	16	801 03 6325	2,43 €	120	16	24	64	56,5
63x32	16	801 03 6332	2,29 €	120	18	24	63,5	57,5
63x40	16	801 03 6340	2,43 €	80	20,5	24	63	53
63x50	16	801 03 6350	2,49 €	60	23,5	24	67	53
75x50	16	801 03 7550	2,67 €	50	23,5	26	75,5	61,5
75x63	16	801 03 7563	2,89 €	40	27,5	26	84,5	67
90x63	16	801 03 9063	4,63 €	36	27,5	29	91	76,5
90x75	16	801 03 9075	5,54 €	24	30	29	98	81,5
110x63	16	801 03 11063	6,77 €	18	27,5	32,5	111	88
110x75	16	801 03 11075	6,89 €	18	30	32,5	111	91,5
110x90	16	801 03 11090	7,07 €	18	33	32,5	119	93,5
125x110	16	801 03 125110	11,74 €	18	37	35	147	102

### PPR Körtapa

PPR End Cap

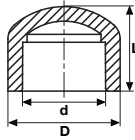

Çap Dia	Basınç Pn	Kod Code	Fiyat (Adet) Price (Pcs)	Koli/Ad. Box/Pcs	D (mm)	L (mm)
20	16	802 20 020 2	0,13 €	800	29	25,5
25	16	802 20 025 2	0,15 €	640	35	29
32	16	802 20 032 2	0,27 €	400	43	32
40	16	802 20 040 2	0,41 €	200	53,5	37
50	16	802 20 050 2	0,96 €	100	67	43,5
63	16	802 20 063 2	2,78 €	80	85	52
75	16	802 20 075 2	2,79 €	48	100,5	58
90	16	802 20 090 2	4,77 €	32	121,5	64
110	16	802 20 110 2	8,47 €	20	146,5	71,5

### PPR Dişli Körtapa

PPR Threaded End Cap

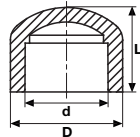

Çap Dia	Basınç Pn	Kod Code	Fiyat (Adet) Price (Pcs)	Koli/Ad. Box/Pcs
20x1/2"	16	802 30 020	0,08 €	1000
25x3/4"	16	802 30 025	0,23 €	640
32x1"	16	802 30 032	0,48 €	400

### PPR Taharet Batarya Bağlantısı

PPR Bidet Faucet Access

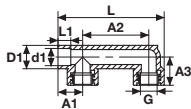

Çap Dia	Basınç Pn	Kod Code	Fiyat (Adet) Price (Pcs)	Koli/Ad. Box/Pcs	L1(min.) (mm)	D1 (mm)	A1 (mm)	A2 (mm)	A3 (mm)	L (mm)
20x1/2"	16	803 60 020	2,79 €	60	14,5	27	28,5	90	31,5	136



**PPR Ayarlı Sıva Altı Batarya Bağlantısı**  
PPR Adjustable Downlight Battery Connection

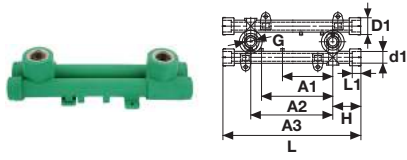

Çap Dia	Basınç Pn	Kod Code	Fiyat (Adet) Price (Pcs)	Koli/Ad. Box/Pcs	L1 min (mm)	D1 (mm)	A1 (mm)	A2 (mm)	A3 (mm)	L (mm)	H (mm)	G (mm)
20x1/2"	16	803 70 020	6,46 €	24	14,5	28	110	145	154	246	47	1/2"

**PPR Sabit Sıva Altı Batarya Bağlantısı (İkili)**  
PPR Fixed Recessed Battery Connection



Çap Dia	Basınç Pn	Kod Code	Fiyat (Adet) Price (Pcs)	Koli/Ad. Box/Pcs	L1 min (mm)	D1 (mm)	A1 (mm)	A2 (mm)	G (mm)
20x1/2"	16	803 80 020	4,04 €	24	16	34	32	150	1/2"
25x1/2"	16	803 80 025	4,75 €	24	16	34	32	150	1/2"

**PPR Sıva Altı Batarya Bağlantısı (İçten Dişli)**  
PPR Recessed Battery Connector Female Threaded



Çap Dia	Basınç Pn	Kod Code	Fiyat (Adet) Price (Pcs)	Koli/Ad. Box/Pcs
20x1/2"	16	802 80 020	1,16 €	200
25x1/2"	16	802 80 025	1,78 €	180

**PPR Sıva Altı Batarya Bağlantısı (Dıştan Dişli)**  
PPR Recessed Battery Connector Male Threaded



Çap Dia	Basınç Pn	Kod Code	Fiyat (Adet) Price (Pcs)	Koli/Ad. Box/Pcs
20x1/2"	16	802 90 020	2,47 €	180
25x1/2"	16	802 90 025	2,53 €	180

**PPR Pislik Tutucu (Erkek)**  
PPR Strainer

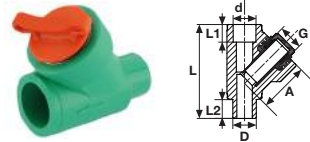

Çap Dia	Basınç Pn	Kod Code	Fiyat (Adet) Price (Pcs)	Koli/Ad. Box/Pcs	L1(min.) (mm)	D (mm)	L2(min.) (mm)	L (mm)	A (mm)
20x1/2"	16	805 50 020	2,77 €	120	14,5	20	11	80	42,5
25x3/4"	16	805 50 025	3,46 €	100	16	25	12,5	101	50

**PPR Vana**  
PPR Valve

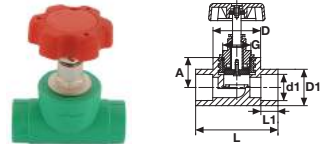

Çap Dia	Basınç Pn	Kod Code	Fiyat (Adet) Price (Pcs)	Koli/Ad. Box/Pcs	L1(min.) (mm)	D1 (mm)	D (mm)	A (mm)	L (mm)	G (mm)
20	16	803 90 020	4,27 €	70	14,5	28,5	38,5	26,5	72	1/2"
25	16	803 90 025	5,10 €	70	16	33,5	42,5	30	77	3/4"
32	16	803 90 032	7,73 €	42	18	43	53,5	38,5	80,5	1"
40	16	803 90 040	19,23 €	30	20,5	54	69	42	111	1-1/4"

**PPR Kelebek Başlı Küresel Vana**  
PPR Butterfly Head Ball Valve

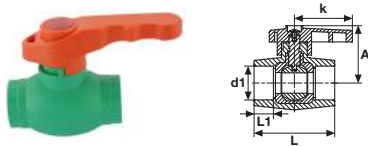

Çap Dia	Basınç Pn	Kod Code	Fiyat (Adet) Price (Pcs)	Koli/Ad. Box/Pcs	L1(min.) (mm)	A (mm)	k (mm)	L (mm)
20	16	804 00 020	5,24 €	120	14,5	60	119	68
25	16	804 00 025	6,37 €	120	16	60	119	68
32	16	804 00 032	8,43 €	80	18	63	119	75
40	16	804 00 040	15,48 €	48	20,5	71	119	89
50	16	804 00 050	18,90 €	28	23,5	78	119	112
63	16	804 00 063	37,14 €	15	27,5	90	157	128
75	16	804 00 075	53,57 €	12	30	100	157	148

### PPR Üçgen Başlı Ankastr Vana

PPR Triangle Head Flush Valve

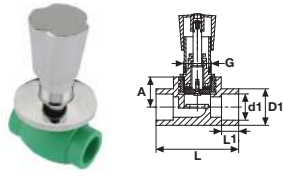

Çap Dia	Basınç Pn	Kod Code	Fiyat (Adet) Price (Pcs)	Koli/Ad. Box/Pcs	L1(min.) (mm)	D1 (mm)	A (mm)	L (mm)	G (mm)
20	16	804 10 020	12,99 €	60	14,5	28,5	26,5	72	3/4"
25	16	804 10 025	14,19 €	60	16	33,5	30	77	3/4"
32	16	804 10 032	17,64 €	50	18	43	38,5	80,5	1"

### PPR Üçgen Başlı Ankastr Küresel Vana

PPR Triangle Head Built-in Ball Valve

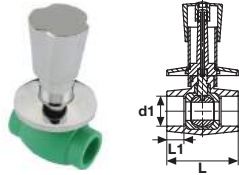

Çap Dia	Basınç Pn	Kod Code	Fiyat (Adet) Price (Pcs)	Koli/Ad. Box/Pcs	L1(min.) (mm)	L (mm)
20	16	804 20 020	19,34 €	60	14,5	68
25	16	804 20 025	20,11 €	60	16	68

### PPR Dekoratif Başlı Ankastr Küresel Vana

PPR Decorative Brads Built-in Ball Valve

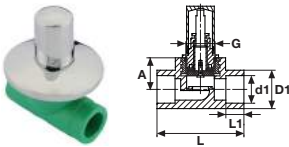

Çap Dia	Basınç Pn	Kod Code	Fiyat (Adet) Price (Pcs)	Koli/Ad. Box/Pcs	L1(min.) (mm)	D1 (mm)	A (mm)	L (mm)	G (mm)
20	16	804 30 020	9,53 €	60	14,5	28,5	26,5	72	3/4"
25	16	804 30 025	10,52 €	60	16	33,5	30	77	3/4"
32	16	804 30 032	13,75 €	50	18	43	38,5	80,5	1"

### PPR Küresel Radyatör Düz Vana

PPR Global Radiators Flat Valve

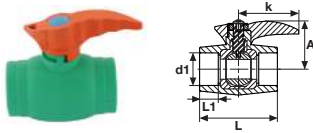

Çap Dia	Kod Code	L1(min.) (mm)	A (mm)	k (mm)	L (mm)	Basınç Pn	Koli/Ad. Box/Pcs	Fiyat (Adet) Price (Pcs)
20	805 20 020	14,5	60	119	68	16	80	7,53 €

### PPR Küresel Radyatör Dirsek Vana

PPR Global Radiators Elbow Valve

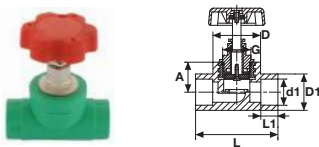

Çap Dia	Kod Code	Basınç Pn	Koli/Ad. Box/Pcs	Fiyat (Adet) Price (Pcs)
20	805 30 020	16	80	7,53 €







**U-PVC**

**CONTALI EK PARÇALAR**

GASKET SOCKETED FITTINGS

ÜRETİM STANDARDI / PRODUCTION STANDARD

EN 1452-3

ÇAP / SIZE Ø20 - Ø400



**U-PVC 22,5° Geçme Muflu Dirsek F/F**  
UH-PVC 22,5° Elbow With Double Rubber-Ring F/F

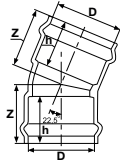

Çap Dia	Basınç PN	Kod Code	Fiyat (Adet) Price (Pcs)	Kg /Adet Kg/Pcs	Koli/Adet Box/Pcs	Z (mm)	h (mm)
110	10	600 00 110 4	30,34 €	18,5	11	152	122
160	10	600 00 160 4	65,15 €	17,4	5	166	140
200	10	600 00 200 4	99,7 €	23,5	4	190	155
225	10	600 00 225 4	142,6 €	13,9	2	191	166
250	10	600 00 250 4	159,5 €	16,9	2	224	180
315	10	600 00 315 4	318,58 €	15,9	1	268	198

**U-PVC 45° Geçme Muflu Dirsek F/F**  
UH-PVC 45° Elbow With Double Rubber-Ring F/F

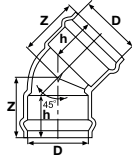

Çap Dia	Basınç PN	Kod Code	Fiyat (Adet) Price (Pcs)	Kg /Adet Kg/Pcs	Koli/Adet Box/Pcs	Z (mm)	h (mm)
63	10	601 00 063 4	9,97 €	14,5	36	92	76
75	10	601 00 075 4	26,88 €	13,5	20	103	81,5
90	10	601 00 090 4	29,04 €	19,5	18	136	114
110	10	601 00 110 4	31,64 €	1,82	9	162	122
160	10	601 00 160 4	65,02 €	19,0	5	183	141
200	10	601 00 200 4	108,79 €	19,4	3	210	155
225	10	601 00 225 4	159,94 €	15,0	2	222	166
250	10	601 00 250 4	169,91 €	18,5	2	248	180
315	10	601 00 315 4	350,21 €	17,4	1	298	195
355	10	601 00 355 4	547,00 €	19,2	1	292	205

**U-PVC 90° Geçme Muflu Dirsek M/F**  
UH-PVC 90° Elbow With Double Rubber-Ring M/F

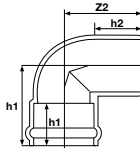

Çap Dia	Basınç PN	Kod Code	Fiyat (Adet) Price (Pcs)	Kg /Adet Kg/Pcs	Koli/Adet Box/Pcs	Z1 (mm)	Z2 (mm)	h1 (mm)	h2 (mm)
225	10	603 00 225 4	172,51 €	16,5	2	312	296	166	170
250	10	603 00 250 4	178,57 €	16,5	2	337	340	182	178
355	10	603 00 355 4	390,10 €	16,5	1	393	378	198	222



### U-PVC 90° Geçme Mufllu Dirsek F/F

UH-PVC 90° Elbow With Double Rubber-Ring F/F

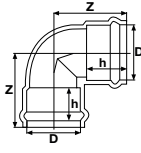

Çap Dia	Basınç PN	Kod Code	Fiyat (Adet) Price (Pcs)	Kg /Adet Kg/Pcs	Koli/Adet Box/Pcs	Z (mm)	h (mm)
63	10	602 00 063 4	11,27 €	18,8	42	112	76
75	10	602 00 075 4	30,12 €	20,0	18	123	81,5
90	10	602 00 090 4	31,64 €	0,65	28	165	114
110	10	602 00 110 4	33,80 €	2,00	8	190	122
160	10	602 00 160 4	76,28 €	16,3	4	229	142
200	10	602 00 200 4	119,63 €	1,00	3	266	153
225	10	602 00 225 4	182,04 €	19,7	2	312	163
250	10	602 00 250 4	220,19 €	11,5	2	338	177
315	10	602 00 315 4	398,76 €	19,7	1	393	198
355	10	602 00 355 4	659,26 €	23,2	1	393	206

### U-PVC 90° Geçme Mufllu Te M/F/F

UH-PVC 90° Elbow With Double Rubber-Ring M/F/F

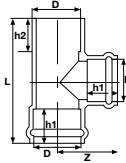

Çap Dia	Basınç PN	Kod Code	Fiyat (Adet) Price (Pcs)	Kg /Adet Kg/Pcs	Koli/Adet Box/Pcs	L (mm)	Z (mm)	h1 (mm)	h2 (mm)
110	10	604 00 110 4	42,48 €	24,4	5	410	206	122	130
160	10	604 00 160 4	106,19 €	24,4	3	480	238	141	144
200	10	604 00 200 4	180,31 €	24,4	2	560	280	155	155
225	10	604 00 225 4	248,78 €	24,4	2	615	308	166	167
250	10	604 00 250 4	259,20 €	24,4	2	670	333	180	182
315	10	604 00 315 4	549,12 €	24,4	1	780	390	198	198

### U-PVC 90° Geçme Mufllu İnegal Te M/F/F

UH-PVC 90° Reducing Tee With Double Rubber-Ring M/F/F

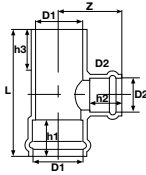

Çap Dia	Basınç PN	Kod Code	Fiyat (Adet) Price (Pcs)	Kg /Adet Kg/Pcs	Koli/Adet Box/Pcs	L (mm)	Z (mm)	h1 (mm)	h2 (mm)	h3 (mm)
160 - 110	10	605 00 160110 4	98,39 €	15,5	3	440	220	141	122	144
200 - 110	10	605 00 200110 4	139,99 €	15,5	2	477	235	155	122	155
200 - 160	10	605 00 200160 4	168,17 €	15,5	2	530	255	155	141	155
225 - 110	10	605 00 225110 4	186,82 €	16,5	2	495	250	166	122	167
225 - 160	10	605 00 225160 4	196,34 €	16,5	2	550	270	166	141	167
250 - 110	10	605 00 250110 4	184,58 €	16,5	2	515	265	180	122	182
250 - 160	10	605 00 250160 4	224,52 €	16,5	2	570	285	180	141	182
250 - 200	10	605 00 250200 4	253,99 €	16,5	2	616	315	180	155	182
315 - 110	10	605 00 315110 4	379,25 €	16,5	2	575	312	198	122	197
315 - 160	10	605 00 315160 4	420,86 €	16,5	1	618	318	198	141	197
315 - 200	10	605 00 315200 4	468,11 €	16,5	1	663	344	198	155	197



**U-PVC 90° Geçme Mufllu Dirsek Te F/F/F**  
UH-PVC 90° Tee With Double Rubber-Ring F/F/F

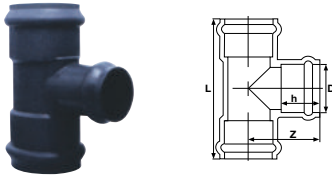

Çap Dia	Basınç PN	Kod Code	Fiyat (Adet) Price (Pcs)	Kg /Adet Kg/Pcs	Koli/Adet Box/Pcs	L (mm)	h (mm)	Z (mm)
63	10	606 00 063 4	15,60 €	640	30	224	76	112
75	10	606 00 075 4	31,64 €	1,00	12	245	81	122
90	10	606 00 090 4	52,87 €	2,10	8	330	115	165
110	10	606 00 110 4	56,35 €	3,36	5	410	112	206
160	10	606 00 160 4	116,59 €	18,9	3	470	141	238
200	10	606 00 200 4	193,31 €	1,00	2	560	152	280
225	10	606 00 225 4	265,69 €	0,15	2	615	166	308
250	10	606 00 250 4	292,01 €	15,0	2	666	176	333
315	10	606 00 315 4	562,60 €	27,0	1	780	198	390
355	10	606 00 355 4	892,87 €	31,0	1	786	206	393

**U-PVC 90° Geçme Mufllu İnegal Te F/F/F**  
UH-PVC 90° Reducing Tee With Double Rubber F/F/F

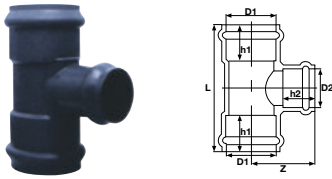

Çap Dia	Basınç PN	Kod Code	Fiyat (Adet) Price (Pcs)	Kg /Adet Kg/Pcs	Koli/Adet Box/Pcs	L (mm)	Z (mm)	h1 (mm)	h2 (mm)
90 - 63	10	607 00 090063 4	47,68 €	1,44	9	304	128	115	76
90 - 75	10	607 00 090075 4	50,71 €		9	304	153	115	81
110 - 63	10	607 00 110063 4	53,32 €	2,42	4	340	141	122	76
110 - 75	10	607 00 110075 4	54,18 €		4	340	138	122	81
110 - 90	10	607 00 110090 4	55,08 €	2,57	4	340	197	122	115
160 - 63	10	607 00 160063 4	95,35 €		4	384	169	141	76
160 - 75	10	607 00 160075 4	97,96 €		4	384	175	141	81
160 - 90	10	607 00 160090 4	100,99 €		4	384	225	141	115
160 - 110	10	607 00 160110 4	107,06 €		3	430	220	142	122
200 - 63	10	607 00 200063 4	127,86 €		2	416	195	152	76
200 - 75	10	607 00 200075 4	134,36 €		2	416	200	152	81
200 - 90	10	607 00 200090 4	143,04 €		2	416	250	152	115
200 - 110	10	607 00 200110 4	150,41 €		2	477	235	155	122
200 - 160	10	607 00 200160 4	172,51 €		2	535	255	155	142
225 - 110	10	607 00 225110 4	196,78 €	24,4	2	492	250	166	122
225 - 160	10	607 00 225160 4	207,61 €	9,9	2	545	270	166	142
250 - 110	10	607 00 250110 4	209,35 €		2	516	265	180	122
250 - 160	10	607 00 250160 4	251,39 €		2	576	285	180	142
250 - 200	10	607 00 250200 4	272,59 €		2	618	315	180	155
315 - 110	10	607 00 315110 4	424,76 €	16,5	1	570	312	198	122
315 - 160	10	607 00 315160 4	468,13 €	17,5	1	618	317	198	142
315 - 200	10	607 00 315200 4	511,45 €		1	658	344	198	155
355 - 160	10	607 00 355160 4	576,47 €	19,5	1	616	343	206	142
355 - 200	10	607 00 355200 4	592,07 €		1	616	387	206	155
355 - 225	10	607 00 355225 4	640,61 €		1	664	370	206	166
355 - 250	10	607 00 355250 4	669,65 €		1	664	413	206	117

### U-PVC 90° Geçme Mufllu Flanş Bağlantılı Te M/F

UH-PVC 90° Tee With Flange End M/F

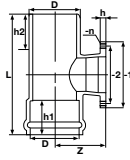

Çap Dia	Basınç PN	Kod Code	Fiyat (Adet) Price (Pcs)	Kg /Adet Kg/Pcs	Koli/Adet Box/Pcs	L (mm)	h (mm)	h1 (mm)	h2 (mm)	Q1 (mm)	Q2 (mm)	Z (mm)	Q-n (mm)
110	10	608 00 110 4	62,32 €	0,017	5	410	122	127	21	180	225	225	225
160	10	608 00 160 4	146,12 €	0,020	3	480	141	144	24	240	285	285	285
200	10	608 00 200 4	261,05 €	0,021	2	560	155	155	28	295	340	340	340
225	10	608 00 225 4	292,19 €	0,025	2	615	166	167	30	295	340	340	340

### U-PVC 90° Geçme Mufllu Flanş Bağlantılı İnegal Te M/F

UH-PVC 90° Reducing Tee With Flange End M/F

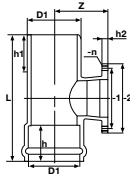

Çap Dia	Basınç PN	Kod Code	Fiyat (Adet) Price (Pcs)	Kg /Adet Kg/Pcs	Koli/Adet Box/Pcs	L (mm)	h (mm)	h1 (mm)	h2 (mm)	Q1 (mm)	Q2 (mm)	Z (mm)	Q-n (mm)
160 - 110	10	609 00 160110 4	118,73 €	0,02	3	440	141	144	21	180	225	191	17,5x8
200 - 110	10	609 00 200110 4	160,33 €	0,01	2	477	155	155	21	180	225	210	17,5x8
200 - 160	10	609 00 200160 4	210,71 €	0,01	2	530	155	155	24	240	285	216	22x8
225 - 110	10	609 00 225110 4	186,34 €	0,01	2	495	166	167	21	180	225	225	17,5x8
225 - 160	10	609 00 225160 4	206,38 €	0,02	2	550	166	167	24	240	285	230	22x8
250 - 110	10	609 00 250110 4	217,10 €	0,01	2	515	180	182	21	180	225	238	17,5x8
250 - 160	10	609 00 250160 4	243,22 €	0,02	2	570	180	182	24	240	285	240	22x8
250 - 200	10	609 00 250200 4	276,66 €	0,02	2	616	180	180	28	295	240	260	2x8
315 - 110	10	609 00 315110 4	512,71 €	0,01	1	575	198	197	21	180	225	279	17,5x8
315 - 160	10	609 00 315160 4	517,58 €	0,01	1	618	198	197	24	240	285	277	22x8
315 - 200	10	609 00 315200 4	521,98 €	0,02	1	663	198	197	28	295	340	292	2x8

### U-PVC Geçme Mufllu Flanş Bağlantılı Manşon F

UH-PVC 90° Flange Socket With Rubber-Ring F

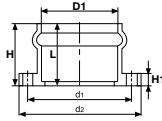

Çap Dia	Basınç PN	Kod Code	Fiyat (Adet) Price (Pcs)	Kg /Adet Kg/Pcs	Koli/Adet Box/Pcs	D1 (mm)	D2 (mm)	H (mm)	H1 (mm)	L (mm)	Q-n (mm)
63	10	610 00 063 4	20,6 €	0,01	42	125	165	88	16	76	17,5 x 4
75	10	610 00 075 4	21,7 €	0,03	25	145	185	92	16	81	17,5 x 4
90	10	610 00 090 4	24,88 €	1,50	15	160	200	122	20	113	17,5 x 8
110	10	610 00 110 4	30,73 €	1,00	10	180	225	148	21	124	17,5 x 8
160	10	610 00 160 4	56,84 €	2,50	8	240	285	154	24	142	22 x 8
200	10	610 00 200 4	97,21 €	0,01	4	295	336	167	27	153	22 x 8
225	10	610 00 225 4	131,64 €	5,30	2	295	340	173	31	163	22 x 8
250	10	610 00 250 4	173,59 €	7,50	2	350	395	188	33	177	22 x 12
315	10	610 00 315 4	214,25 €	8,50	2	400	445	215	36	199	22 x 12
355	10	610 00 355 4	289,16 €	0,02	2	445-460	505	225	38	209	22 x 16
400	10	610 00 400 4	332,06 €	0,02	2	495-515	565	247	41	227	26 x 16



**U-PVC Flanşlı Adaptör**  
UH-PVC 90° Flanged Spigot M

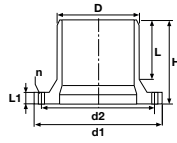

Çap Dia	Basınç PN	Kod Code	Fiyat (Adet) Price (Pcs)	Kg /Adet Kg/Pcs	Koli/Adet Box/Pcs	D1 (mm)	D2 (mm)	H (mm)	L (mm)	L1 (mm)	Q-n (mm)
63	10	611 00 063 4	20,60 €	0,67	42	125	165	110	80	16	17,5 x 4
75	10	611 00 075 4	21,71 €	0,01	25	145	185	130	85	16	17,5 x 4
90	10	611 00 090 4	25,75 €	17,5	15	160	200	153	115	20	17,5 x 8
110	10	611 00 110 4	27,70 €	1,00	10	180	225	167	125	21	17,5 x 8
160	10	611 00 160 4	49,48 €	22,1	8	240	285	196	146	25	22 x 8
200	10	611 00 200 4	90,72 €		4	295	336	215	166	32	22 x 8
225	10	611 00 225 4	133,80 €	17	2	295	340	226	170	31	22 x 8
250	10	611 00 250 4	141,52 €	0,017	2	350	395	257	180	33	22 x 12
315	10	611 00 315 4	214,25 €	18	2	400	445	297	200	36	22 x 12
355	10	611 00 355 4	312,00 €	18	2	445-460	505			38	22 x 16
400	10	611 00 400 4	332,06 €	28,7	2	495-515	565	303	235	41	26 x 16

**U-PVC Geçme Mufllu Redüksiyonlu Manşon F/F**  
UH-PVC Reducing Socket With Double Rubber-Ring F/F

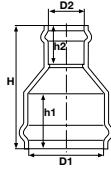

Çap Dia	Basınç PN	Kod Code	Fiyat (Adet) Price (Pcs)	Kg /Adet Kg/Pcs	Koli/Adet Box/Pcs	L (mm)	Z (mm)	h1 (mm)	h2 (mm)
90 - 63	10	612 00 090063 4	20,38 €	0,70	28	304	128	115	76
90 - 75	10	612 00 090075 4	22,10 €	1,00	22	304	153	115	81
110 - 63	10	612 00 110063 4	23,40 €	1,06	18	340	141	122	76
110 - 90	10	612 00 110090 4	25,14 €	1,23	16	340	197	122	115
160 - 110	10	612 00 160110 4	55,48 €	2,00	8	430	220	142	122
200 - 110	10	612 00 200110 4	65,02 €	15,5	4	477	235	155	122
200 - 160	10	612 00 200160 4	69,35 €	1,20	4	535	255	155	142
225 - 110	10	612 00 225110 4	78,30 €		4	492	250	166	122
225 - 160	10	612 00 225160 4	82,36 €		4	545	270	166	142
225 - 200	10	612 00 225200 4	86,69 €		2				
250 - 110	10	612 00 250110 4	99,70 €		4	516	265	180	122
250 - 160	10	612 00 250160 4	104,03 €	5,50	4	576	285	180	142
250 - 200	10	612 00 250200 4	108,36 €	1,60	2	618	315	180	155
250 - 225	10	612 00 250225 4	112,69 €		2				
315 - 110	10	612 00 315110 4			2	570	312	198	122
315 - 160	10	612 00 315160 4	216,72 €		2	618	317	198	142
315 - 200	10	612 00 315200 4	238,38 €		2	658	344	198	155
355 - 160	10	612 00 355160 4			2	616	343	206	142
355 - 200	10	612 00 355200 4	313,80 €	40,0	2	616	387	206	155
355 - 225	10	612 00 355225 4			1	664	370	206	166
355 - 250	10	612 00 355250 4			1	664	413	206	117

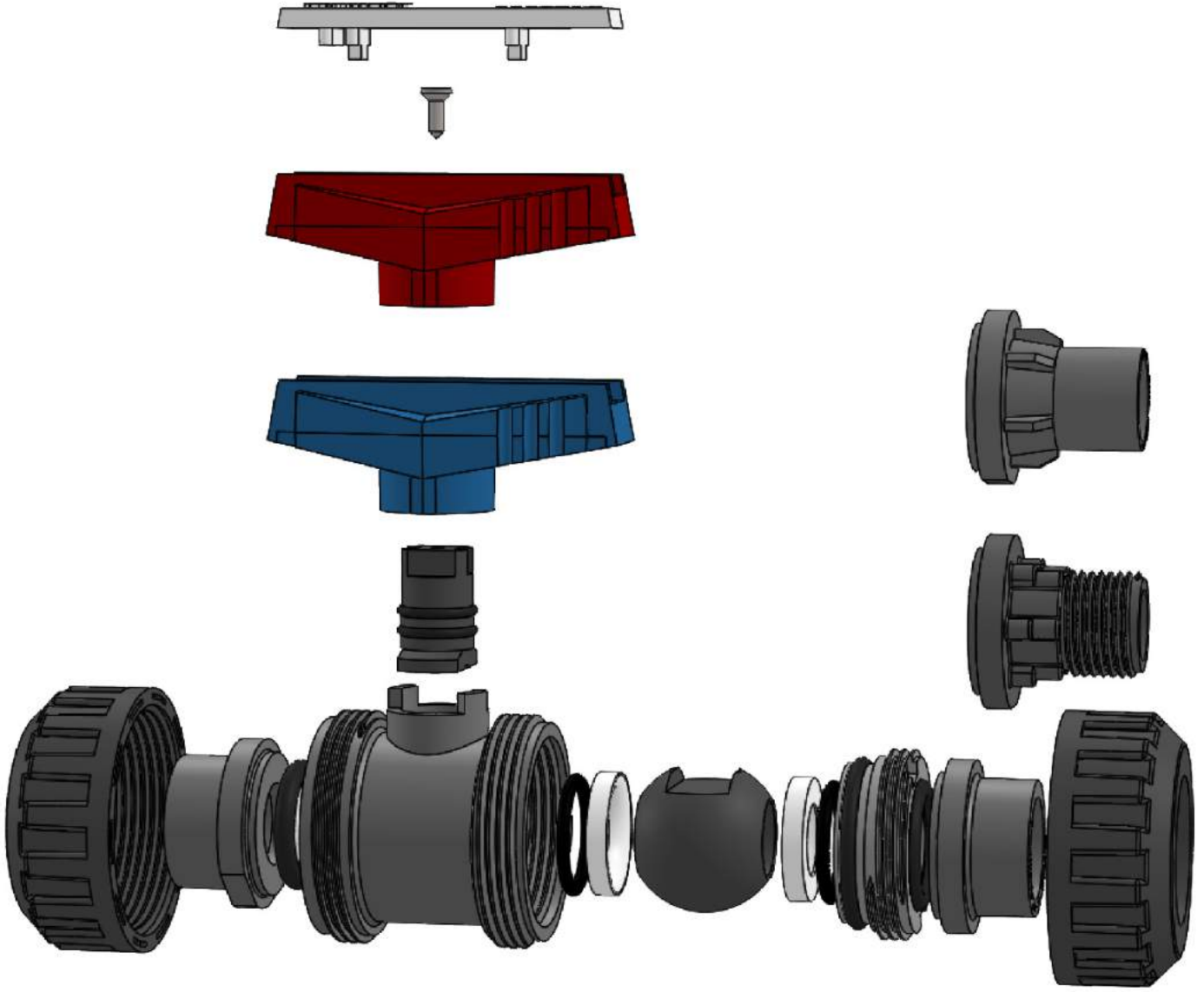

## YEDEK PARÇALAR SPARE PARTS

ÜRETİM STANDARDI / PRODUCTION STANDARD  
EN 1452-3



**U-PVC Kelebek Vana Yedek Parça Listesi**  
U-PVC Butterfly Valve Spare List

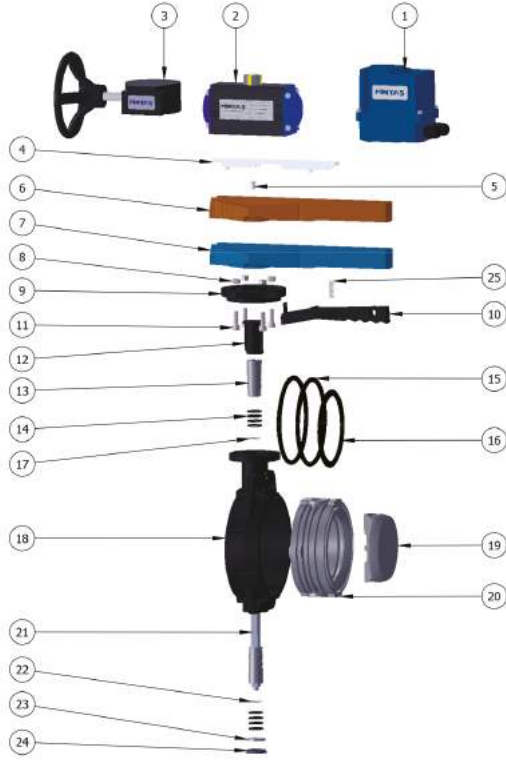

No	Parça Part	Malzeme Material	Adet QTY
1	Elektrikli Aktuatör		1
2	Pnomatik Aktuatör		1
3	Direksiyon		1
4	Kol Kapağı / Lever Clip	PVC	1
5	Civata / Screw	INOX	1
6	Kol / Handle ( Su Vanası Kullanımı )	ABS	1
7	Kol / Handle ( Asit Vanası Kullanımı )	ABS	1
8	Somun / Nut	INOX	4
9	Çark / Index Plate	PP GF	1
10	Mandal / Lever Catch	PP GF	1
11	Civata / Screw	INOX	4
12	Stop Parçası / End Stop	PP GF	1
13	Pim / Step	U-PVC / PP / C-PVC	1
14	Pim O-Ring / Step O-Ring	EPDM / FPM	8
15	İç Gövde Alın O-Ring	EPDM / FPM	2
16	İç Gövde O-Ring / Inner Seal	EPDM / FPM	1
17	Segman / Retaining Rings	INOX	1
18	Dış Gövde / Body	PP GF	1
19	Klape / Disc	U-PVC / PP / C-PVC	1
20	İç Gövde / Inner Body	U-PVC / PP / C-PVC	1
21	Şaft / Steel Shaft	STEEL	1
22	Segman / Retaining rings	INOX	1
23	Pul / Washer	INOX	1
24	Tapa / Cap	PP GF	1
25	Yay / Spring	INOX	1

No	Ø63 Kod /Code	Fiyat (Adet) Price (Pcs)	Ø75 Kod /Code	Fiyat (Adet) Price (Pcs)	Ø90 Kod /Code	Fiyat (Adet) Price (Pcs)	Ø110 Kod /Code	Fiyat (Adet) Price (Pcs)	Ø125-Ø140 Kod /Code	Fiyat (Adet) Price (Pcs)	
1	700006329	255,90 €	700007529	251,9	700009026	251,9	700009026	356,84 €	700011026	356,99 €	
2	700040027	260,96 €	700007527	256,96	700009027	256,96	700009027	25,74 €	700011027	283,88 €	
3	700040028	30,00 €	700007528	30,00 €	700009028	30,00 €	700009028	30,00 €	700011028	30,00 €	
4	202050902	0,90 €	202050902	0,90 €	202050902	0,90 €	202050902	0,90 €	202050902	2,00 €	
5	2021501409	2,10 €	2021501409	2,10 €	2021501409	2,10 €	2021501409	2,10 €	2021501409	2,10 €	
6	291139904	13,00 €	291139904	13,00 €	291139904	13,00 €	291139904	15,00 €	291131104	15,00 €	
7	291130905	13,00 €	29113905	13,00 €	29113905	13,00 €	29113905	15,00 €	291131105	15,00 €	
8	201151969	0,50 €	201151969	0,50 €	201151969	0,50 €	201151969	0,50 €	201151969	0,50 €	
9	400267952	6,80 €	400267952	6,80 €	400267952	6,80 €	400267952	7,50 €	400267952	7,50 €	
10	400267962	6,00 €	400267962	6,00 €	400267962	6,00 €	400267962	7,00 €	400261112	7,00 €	
11	201151979	0,30 €	201151979	0,30 €	201151979	0,30 €	201151979	0,30 €	201151979	0,30 €	
12	400267982	1,50 €	400267982	1,50 €	400267982	1,50 €	400267182	1,50 €	400267182	1,50 €	
13	201019995	0,10 €	201019995	0,10 €	201019995	0,10 €	201011115	0,10 €	201011115	0,20 €	
EPDM	14	201999999	0,75 €	201999999	0,75 €	201999999	0,75 €	201999998	1,00 €	201999998	1,00 €
FPM	14	201999900	5,25 €	201999900	5,25 €	201999900	5,25 €	201999990	7,00 €	201999990	7,00 €
EPDM	15	201030637	1,75 €	201030757	2,50 €	202030909	3,00 €	202031109	4,00 €	K00203779	5,00 €
FPM	15	201030639	12,25 €	201030758	17,50 €	205030909	21,00 €	406031109	28,00 €	K0023770	35,00 €
EPDM	16	201020639	1,75 €	201020759	2,50 €	201020909	3,00 €	201021109	4,00 €	201021409	5,00 €
FPM	16	201020630	12,25 €	201020750	17,50 €	201020900	21,00 €	201021100	28,00 €	201021400	35,00 €
17	102310209	6,80 €	102310209	6,80 €	102310209	6,80 €	102310209	7,50 €	102310209	7,50 €	
18	400267632	13,00 €	400267752	13,00 €	400267942	13,00 €	400110942	14,00 €	401251402	18,00 €	
19	201137634	7,00 €	201137754	7,00 €	201137974	7,00 €	201137104	9,00 €	201137105	11,00 €	
20	201010635	20,00 €	201010755	20,00 €	201010905	20,00 €	201011105	24,00 €	212514005	28,00 €	
21	201040634	13,00 €	201040754	13,00 €	201040904	13,00 €	201041104	15,00 €	201041254	15,00 €	
22	102310248	0,80 €	102310248	0,80 €	102310248	0,80 €	102310248	1,20 €	102310699	1,20 €	
23	102310259	0,15 €	102310259	0,15 €	102310259	0,15 €	102310259	0,15 €	102310259	0,15 €	
24	400267972	2,00 €	400267972	2,00 €	400267972	2,00 €	400267172	4,00 €	400267172	4,00 €	
25	271351979	1,50 €	271351979	1,50 €	271351979	1,50 €	271351979	1,50 €	271351979	1,50 €	





No	Ø160 Kod /Code	Fiyat (Adet) Price (Pcs)	Ø200-Ø225 Kod /Code	Fiyat (Adet) Price (Pcs)	Ø250-Ø280 Kod /Code	Fiyat (Adet) Price (Pcs)	Ø315 Kod /Code	Fiyat (Adet) Price (Pcs)	Ø400 Kod /Code	Fiyat (Adet) Price (Pcs)
1	700016026	644,24 €	700020026	668,08 €	700025026	1.151,36 €	700031526		700040026	
2	700016027	471,24 €	700020027	519,18 €	700025027	685,95 €	700031527		700040027	
3	700016028	30,00 €	700020028	30,00 €	700025028	50,00 €	700031528		70040028	50,00 €
4	202050902	2,00 €	202051102	2,00 €	202051102	5,40 €	202053152	13,50 €		
5	2021501409	4,00 €	2021501409	7,00 €	2021501409	18,90 €	2021501409	47,25 €		
6	291131104	24,00 €	2911392004	24,00 €	2911392004	64,80 €	2911393154	162,00 €		
7	291131105	24,00 €	291132005	24,00 €	291132005	64,80 €	291133154	162,00 €		
8	201151969	0,90 €	201151969	0,90 €	201151969	2,43 €	201151969	6,08 €		
9	400267952	12,00 €	400267952	13,00 €	400267952	35,10 €	400267952	87,75 €		
10	400261112	11,00 €	400262002	11,00 €	400262002	29,70 €	400263152	74,25 €		
11	201151979	0,30 €	201151979	0,30 €	201151979	0,40 €	201151979	0,40 €		
12	400267182	1,50 €	400267200	1,50 €	400267200	4,05 €	400267200	10,13 €		
13	201011115	0,40 €	201012005	0,50 €	202502805	1,35 €	201019991	3,38 €		
EPDM	14	201999998	1,00 €	2010322542	1,50 €	2010322542	4,05 €	201031595	10,13 €	
FPM	14	201999990	7,00 €							
EPDM	15	K002037799	6,00 €	2010322549	7,00 €	2010325050	18,90 €	2010331549	47,25 €	
FPM	15	K002037790	42,00 €	2010322540	49,00 €	2010325040	132,30 €		330,75 €	
EPDM	16	201021609	6,00 €	2010322544	7,00 €	201032899	18,90 €	2010331544	47,25 €	
FPM	16	201021600	42,00 €	2010322500	49,00 €	201032800	132,30 €		330,75 €	
17	102310209	12,00 €	1023101029	13,00 €	1023101029	35,10 €	1023101029	87,75 €		
18	40160942	29,00 €	401252002	48,00 €	401252502	129,60 €	400315942	324,00 €		
19	201137106	18,00 €	20137205	21,00 €	20132804	56,70 €	201133154	141,75 €		
20	201016005	45,00 €	212520005	75,00 €	201028005	202,50 €	201013156	506,25 €		
21	201041604	24,00 €	201042004	24,00 €	201042804	64,80 €	201043154	162,00 €		
22	102310699	2,10 €	1023101129	2,10 €	1023101129	5,67 €	1023101139	14,18 €		
23	102310259	0,15 €	201120225	0,15 €	201120225	0,41 €	2011200315	1,01 €		
24	400267172	6,00 €	400267225	8,00 €	400267225	21,60 €	400267315	54,00 €		
25	271351979	1,50 €	271351979	1,50 €	271351979	1,50 €	271351979	1,50 €	271351979	1,50 €



**U-PVC Küresel Vana Yedek Parça Listesi**  
U-PVC True Union Ball Valves Spare Parts List

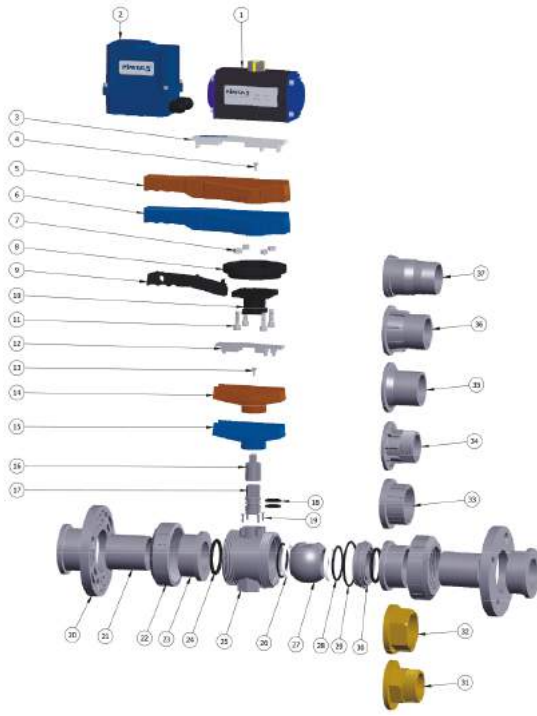

No	Parça Part	Malzeme Material	Adet QTY
1	Phomatik Akuator		1
2	Elektrikli Akuator		1
3	Kol Kapağı / Handle Cover	PVC	1
4	Civata / Screw	INOX	1
5	Kol / Handle ( ASİT VANA KOL )	ABS	1
6	Kol / Horle / ( SU VANA KOL )	ABS	1
7	Somun / Nut	INOX	4
8	Çark / Index Plate	PP GF	1
9	Mandal / Lever Catch	PP GF	1
10	Adaptör Ara Parça	U-PVC	1
11	ISO 4762 M8 x 25 --- 255	INOX	4
12	Kol Kapağı / Handle Cover	ABS	1
13	Civata / Screw	INOX	1
14	Kol Handle ( ASİT )	ABS	1
15	Kol Handle ( SU )	ABS	1
16	Pim Uzatma Parçası	U-PVC	1
17	Pim / Step	U-PVC	1
18	Pim O-Ringi / Step O-Ring	EPDM / FPM	2
19	Vida / Screw	INOX	4

No	Ø20 Kod /Code	Fiyat (Adet) Price (Pcs)	Ø25 Kod /Code	Fiyat (Adet) Price (Pcs)	Ø32 Kod /Code	Fiyat (Adet) Price (Pcs)	Ø40 Kod /Code	Fiyat (Adet) Price (Pcs)	Ø50 Kod /Code	Fiyat (Adet) Price (Pcs)
1	700002026	202,40 €	700002526	202,40 €	700003226	202,40 €	700004026	212,10 €	700006326	240,10 €
2	700002027	225,10 €	700002527	225,10 €	700003227	225,10 €	700004027	245,20 €	700005027	245,20 €
3										
4										
5										
6										
7										
8										
9										
10	201600202	2,00 €	201600202	2,00 €	201600322	3,00 €	201600322	3,00 €	201600502	3,50 €
11	K00201479	1,50 €	K00201479	1,50 €	K00201479	1,50 €	K00201479	1,50 €	K00201479	1,50 €
12	202050202	0,50 €	202050202	0,50 €	202050322	0,73 €	202050405	0,82 €	202050502	0,86 €
13	100304199	0,50 €	100304199	0,50 €	100304199	0,50 €	100304199	0,50 €	100304199	0,50 €
14	205040202	1,10 €	205040202	1,10 €	205040322	1,60 €	205040402	1,80 €	205040502	1,90 €
15	202040202	1,10 €	202040202	1,10 €	202040322	1,60 €	202040402	1,80 €	202040502	1,90 €
16	202090251	1,50 €	202090251	1,50 €	202090321	1,60 €	202090321	1,60 €	202090501	1,90 €
17	202090202	0,70 €	202090202	0,70 €	202090322	0,85 €	202090322	0,85 €	202090502	1,00 €
EPDM 18	202100209	0,10 €	202100209	0,20 €	202100329	0,30 €	202100329	0,30 €	202100509	0,80 €
FPM 18	205100209	0,50 €	205100209	0,70 €	205100329	0,80 €	205100329	0,80 €	205100509	1,00 €
19										
20	513000202	1,15 €	513000252	1,15 €	513000322	1,30 €	513000402	1,50 €	513000502	1,65 €
21	201610202	0,90 €	201610252	0,90 €	201610322	1,10 €	201610402	1,20 €	201610502	1,30 €
22	202010202	1,10 €	202010252	1,10 €	202010322	1,25 €	202010402	1,45 €	202010502	1,60 €
23	512000202	0,55 €	512000252	1,30 €	512000322	1,60 €	512000402	1,80 €	512000502	2,50 €
EPDM 24	202030209	0,50 €	202030259	0,55 €	202100909	0,70 €	202030409	0,79 €	202030509	0,79 €
FPM 24	205030209	1,00 €	205030259	1,10 €	202100909	1,30 €	205030409	2,00 €	205030509	2,00 €
25	202060202	1,80 €	202060252	0,60 €	202060322	0,70 €	202060402	0,70 €	202060502	0,90 €
26	202080202	0,30 €	202080252	2,10 €	202080322	2,90 €	202080402	3,80 €	202080502	7,00 €
27	202110202	1,00 €	202110252	0,40 €	202110322	0,50 €	202110402	0,60 €	202110502	0,70 €
EPDM 28	202070209	0,20 €	202070259	0,30 €	202070329	0,40 €	202120259	0,60 €	202070509	2,10 €
FPM 28	205070209	1,00 €	205070259	1,10 €	205070329	1,40 €	205120259	2,20 €	205070509	3,50 €
EPDM 29	202120209	0,20 €	202120259	0,30 €	202120329	0,40 €	202120409	0,60 €	202070639	0,70 €
FPM 29	205120209	1,00 €	205120259	1,10 €	205120329	1,40 €	205120409	2,20 €	205070639	1,10 €
30	202130202	0,80 €	202130253	0,50 €	202130323	0,70 €	202130402	0,70 €	202130503	0,85 €
31	202170202	3,05 €	202170252	5,90 €	202170322	7,80 €	202170402	11,40 €	202170502	17,50 €
32	202180202	2,55 €	202180252	4,90 €	202180322	6,30 €	202180402	9,90 €	202180502	15,55 €
33	512020202	0,95 €	512020252	1,15 €	512020322	1,35 €	512020402	1,55 €	512020502	2,00 €
34	229060202	1,90 €	229060252	2,30 €	229060322	2,70 €	229060402	3,10 €	229060502	4,00 €
35	900900202	2,61 €	900900252	2,85 €	900900322	3,41 €	900900402	3,64 €	900900502	4,25 €
36	512300202	0,66 €	512300252	1,10 €	512300322	1,32 €	512300402	3,74 €	512300502	4,32 €
37	512600202	0,66 €	512600252	1,10 €	512600322	1,32 €	512600402	3,74 €	512600502	4,32 €





No	Parça Part	Malzeme Material	Adet QTY
20	Flaş / Flange	U-PVC	2
21	Kole Ara Parça	U-PVC	2
22	Somun / Union Nut	U-PVC	2
23	Adaptör	U-PVC	4
24	Gövde O-Ringi / Body O-Ring	EPDM / FPM	2
25	Gövde / Body	U-PVC	1
26	Conta / Gasket	HDPE	2
27	Küre / Ball	U-PVC	1
28	Conta Altı O-Ring / Backing Seals	EPDM / FPM	2
29	Dayama O-Ring	EPDM / FPM	1
30	Küre Dayama / Union Brush	U-PVC	1
31	Dış Diş Adaptör	BRASS	1
32	İç Diş Adaptör	BRASS	1
33	İç Dişli Adaptör	U-PVC	1
34	Dış Dişli Adaptör	U-PVC	1
35	Adaptör	HDPE	1
36	Dış Yapıştırma Adaptör	U-PVC	1
37	Hortum Adaptörü	U-PVC	1

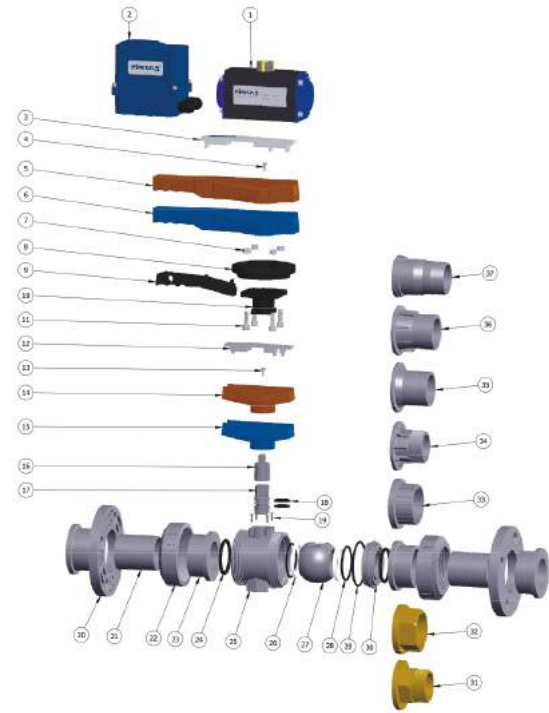

No	Ø63 Kod /Code	Fiyat (Adet) Price (Pcs)	Ø75 Kod /Code	Fiyat (Adet) Price (Pcs)	Ø90 Kod /Code	Fiyat (Adet) Price (Pcs)	Ø110 Kod /Code	Fiyat (Adet) Price (Pcs)	
1	700006326	240,40 €	700007526	306,14 €	700009026	326,72 €	700011026	372,41 €	
2	700006327	286,14 €	700007527	315,00 €	700009027	343,24 €	700011027	361,50 €	
3	202050632	0,90 €	202050902	0,90 €	202050902	0,90 €	202051102	0,90 €	
4	2021501499	2,10 €	2021501499	2,10 €	2021501499	2,10 €	2021501499	2,10 €	
5	291130905	13,00 €	291130905	13,00 €	291130905	13,00 €	291131105	15,00 €	
6	291139904	13,00 €	291139904	13,00 €	291139904	13,00 €	291131104	15,00 €	
7	201151969	0,80 €	201151969	0,80 €	201151969	0,80 €	201151969	0,80 €	
8	400267952	6,80 €	400267952	6,80 €	400267952	6,80 €	400267952	6,80 €	
9	400267962	6,00 €	400267962	6,00 €	400267962	6,00 €	400267962	7,00 €	
10	201600752	4,50 €	201600752	4,50 €	201600902	5,00 €	201600902	5,00 €	
11	K00201479	1,50 €	K00201479	1,50 €	K00201479	1,50 €	K00201479	1,50 €	
12	202050632	0,95 €	202050752	1,73 €	202050902	2,27 €	202051102	3,41 €	
13	100300749	0,80 €	100300749	0,80 €	100300749	0,80 €	100300749	0,80 €	
14	205040632	2,10 €	205040752	3,90 €	205040902	5,00 €	205041102	7,50 €	
15	202040632	2,10 €	202040752	3,80 €	202040902	5,00 €	202041102	7,50 €	
16	202090631	2,10 €	202090631	3,80 €	202090901	5,00 €	202090901	7,50 €	
17	202090632	1,20 €	202090632	1,20 €	202090902	1,80 €	202090902	1,80 €	
EPDM	18	202100639	0,90 €	202100639	1,10 €	202100909	1,70 €	202100909	1,80 €
FPM	18	205100639	1,30 €	205100639	1,30 €	205100909	2,50 €	205100909	2,50 €
19	201150639	0,50 €	201150759	0,50 €	201150759	0,70 €	201150909	0,70 €	
20	513000632	2,15 €	513000752	2,40 €	513000902	2,55 €	513001102	3,39 €	
21	201610632		201610752	1,80 €	201610902	2,10 €	201611102	2,30 €	
22	202010632	2,10 €	202010752	2,35 €	202010902	2,50 €	202011102	3,40 €	
23	512000632	3,30 €	512000752	6,60 €	512000902	9,00 €	512001102	11,00 €	
EPDM	24	202030639	0,81 €	202030759	1,00 €	202030909	1,30 €	202031109	1,75 €
FPM	24	202030639	2,30 €	205030759	2,50 €	205030909	2,90 €	205031109	3,20 €
25	202060632	1,30 €	202050752	2,20 €	202050902	2,90 €	20501109	5,00 €	
26	202080632	15,00 €	202080752	20,00 €	202080902	25,00 €	202081102	335,00 €	
27	202110632	0,70 €	202110752	1,00 €	202110902	1,20 €	202111102	1,40 €	
EPDM	28	202070639	3,10 €	202070759	4,20 €	202070909	9,80 €	202071109	11,10 €
FPM	28	205070639	5,20 €	205070759	11,50 €	205070909	15,00 €	205071109	20,00 €
EPDM	29	202120639	0,70 €	202030909	1,30 €	202120909	1,70 €	202121109	2,20 €
FPM	29	205120639	1,10 €	205030909	1,80 €	205120909	2,10 €	205121109	3,10 €
30	202130633	2,80 €	202130753	3,00 €	202130903	3,90 €	202131102	5,60 €	
31	202170632	40,05 €							
32	202180632	34,55 €							
33	512020632	2,25 €	512020752	3,95 €	512020902	4,35 €	512021102	5,00 €	
34	229060632	4,50 €	229060752	5,90 €	229060902	8,70 €	229061102	10,00 €	
35	900900632	4,85 €	900900752	6,02 €	900900902	7,89 €	900901102	10,78 €	
36	512300632	4,84 €	512300752	7,00 €	512300902	9,90 €	512301102	11,90 €	
37	512600632	4,84 €	512600752	7,00 €	512600902	9,90 €	512601102	11,90 €	



**U-PVC Rakor Yedek Parça Listesi**  
U-PVC Union Spare Parts List

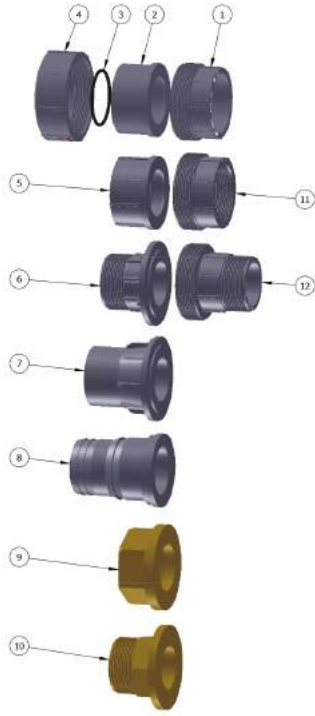

No	Parça Part	Malzeme Material	Adet QTY
1	Rakor Gövde	U-PVC	1
2	Adaptör	U-PVC	1
3	Gövde O-Ring / Body O-Ring	EPDM / FPM	1
4	Somun / Nut	U-PVC	1
5	İç Diş Adaptör	U-PVC	1
6	Dış Diş Adaptör	U-PVC	1
7	Dış Yapıştırma Adaptör	U-PVC	1
8	Hortum Adaptörü	U-PVC	1
9	İç Diş Adaptör	BRASS	1
10	Dış Diş Adaptör	BRASS	1
11	İç Dişli Rakor Gövde	U-PVC	1
12	Dış Diş Rakor Gövde	U-PVC	1

No	Ø20 Kod /Code	Fiyat (Adet) Price (Pcs)	Ø25 Kod /Code	Fiyat (Adet) Price (Pcs)	Ø32 Kod /Code	Fiyat (Adet) Price (Pcs)	Ø40 Kod /Code	Fiyat (Adet) Price (Pcs)	Ø50 Kod /Code	Fiyat (Adet) Price (Pcs)	
1	227050202	1,10 €	227050252	1,90 €	227050322	2,70 €	227050402	2,90 €	227050502	3,70 €	
2	512000202	0,55 €	512000252	0,55 €	512000322	0,70 €	512000402	0,79 €	227010502	0,79 €	
EPDM	3	202030209	1,00 €	202030259	1,20 €	202100909	1,40 €	202030409	1,40 €	202030509	1,80 €
FPM	3	2050302096	3,30 €	205030259	3,60 €	205100909	3,80 €	205030409"	3,80 €	205030509	4,20 €
4	202010202	1,10 €	202010252	1,25 €	202010322	1,60 €	202010402	1,80 €	227020502	2,50 €	
5	512020202	0,95 €	512020252	1,15 €	512020322	1,35 €	512020402	1,55 €	502020502	2,00 €	
6									22906502	2,00 €	
7	512300202	1,15 €	512300252	1,35 €	512300322	1,55 €	512300402	1,75 €	512300502	2,20 €	
8	512600202	0,95 €	512600252	1,15 €	512600322	1,60 €	512600402	1,80 €	512600502	2,50 €	
9	202180202	2,55 €	202180252	4,10 €	202180322	5,20 €	202180402	8,00 €	202180502	14,50 €	
10	202170202	3,05 €	202170252	4,90 €	202170322	6,30 €	202170402	9,90 €	202170502	15,55 €	
11	229050202	1,40 €	229050252	2,20 €	229050322	2,90 €	229050402	3,10 €	229050502	3,90 €	
12	229090202	2,20 €	229090252	3,80 €	229090322	5,40 €	229090402	5,80 €	229090502	7,40 €	

No	Ø63 Kod /Code	Fiyat (Adet) Price (Pcs)	Ø75 Kod /Code	Fiyat (Adet) Price (Pcs)	Ø90 Kod /Code	Fiyat (Adet) Price (Pcs)	Ø110 Kod /Code	Fiyat (Adet) Price (Pcs)	
1	227050632	4,35 €	227050752	9,70 €	227050902	13,85 €	227051102	16,60 €	
2	227010632	0,81 €	512000752	1,00 €	512000902	1,30 €	512001102	2,07 €	
EPDM	3	202030639	2,60 €	202030759	4,40 €	202030909	5,80 €	202031109	10,00 €
FPM	3	205030639	4,70 €	205030759	7,00 €	205030909	8,10 €	406031109	16,50 €
4	227020632	3,30 €	227010752	6,60 €	227020902	9,00 €	202010902	11,00 €	
5	512020632	2,25 €	512020752	3,95 €	512020902	4,35 €	512021102	5,00 €	
6	229060632	2,25 €							
7	512300632	2,45 €	512300752	4,15 €	512300902	4,55 €	512301102	5,20 €	
8	512600632	3,30 €	512600752	6,60 €	512600902	9,00 €	512601102	11,00 €	
9	202180632	28,75 €							
10	202170632	34,55 €							
11	229050632	4,95 €	229050752	11,00 €	229050902	14,30 €	229051102	17,20 €	
12	229090632	8,70 €	229090752	19,40 €	229090902	27,70 €	229091102	33,20 €	



## U-PVC Çıplak Çalparalı Çekvalf Yedek Parça Listesi

### U-PVC Wafer Check Valve Spare Parts List



No	Parça Part	Malzeme Material	Adet QTY
1	Gövde / Body	U-PVC	1
2	Klape O-Ringi / Carrier O-Ring	EPDM / FPM	1
3	Klape / Clack	U-PVC	1
4	Yay / Spring	Stainless Steel	1
5	Gövde O-Ringi / Body O-Ring	EPDM / FPM	2
6	Klape Tapası / Clack Plug	U-PVC	2

No	Ø63 Kod /Code	Fiyat (Adet) Price (Pcs)	Ø75 Kod /Code	Fiyat (Adet) Price (Pcs)	Ø90 Kod /Code	Fiyat (Adet) Price (Pcs)	Ø110 Kod /Code	Fiyat (Adet) Price (Pcs)	Ø125 Kod /Code	Fiyat (Adet) Price (Pcs)	
EPDM	1	221020632	11,00 €	221020752	13,00 €	221020902	15,00 €	221021102	17,00 €	221021252	20,00 €
FPM	2	221160908	1,10 €	221160759	1,30 €	221160909	1,60 €	221161109	1,90 €	221161259	2,50 €
EPDM	2	221160631	4,40 €	221160751	5,20 €	221160901	6,40 €	221161101	7,60 €	221161251	10,00 €
FPM	3	221030632	11,00 €	221030752	13,00 €	221030902	15,00 €	221031102	17,00 €	221031252	20,00 €
EPDM	4	221170639	5,00 €	221170759	5,00 €	221170909	6,00 €	221171109	6,00 €	221171259	7,00 €
FPM	5	221150908	1,65 €	221150759	1,95 €	221150909	2,40 €	221151109	2,85 €	221151259	3,75 €
EPDM	5	2211506631	6,60 €	221150751	7,80 €	221150901	9,60 €	221151101	11,40 €	221151251	15,00 €
FPM	6	221120902	1,00 €	221120902	1,00 €	221120902	1,00 €	221121102	1,00 €	221121102	1,00 €

No	Ø140 Kod /Code	Fiyat (Adet) Price (Pcs)	Ø160 Kod /Code	Fiyat (Adet) Price (Pcs)	Ø200 Kod /Code	Fiyat (Adet) Price (Pcs)	Ø225 Kod /Code	Fiyat (Adet) Price (Pcs)	
EPDM	1	221021402	23,00 €	221021602	26,00 €	221022002	32,00 €	221022252	36,00 €
FPM	2	221161409	3,00 €	221161609	4,50 €	221162009	6,00 €	221162259	7,00 €
EPDM	2	221161401	12,00 €	221161601	18,00 €	221162001	24,00 €	221162251	28,00 €
FPM	3	221031402	23,00 €	221031602	26,00 €	221032002	32,00 €	221032252	36,00 €
EPDM	4	221171409	7,00 €	221171609	7,00 €	221172009	8,00 €	221172259	8,00 €
FPM	5	221151409	4,50 €	221151609	6,75 €	221152009	9,00 €	221152259	10,50 €
EPDM	5	221151401	18,00 €	221151601	27,00 €	221152001	36,00 €	221152251	42,00 €
FPM	6	221121102	1,00 €	221121102	1,00 €	221121102	1,00 €	221121102	1,00 €

No	Ø250 Kod /Code	Fiyat (Adet) Price (Pcs)	Ø280 Kod /Code	Fiyat (Adet) Price (Pcs)	Ø315 Kod /Code	Fiyat (Adet) Price (Pcs)	Ø400 Kod /Code	Fiyat (Adet) Price (Pcs)	
EPDM	1	221022502	7,00 €	221022502	105,00 €	22102315252	135,00 €	221024002	300,00 €
FPM	2	221162509	11,00 €	221162509	15,00 €	221163151	28,00 €	221164009	36,00 €
EPDM	2	221162501	44,00 €	221162501	60,00 €	221163151	112,00 €	221164001	144,00 €
FPM	3	221032502	70,00 €	221032502	105,00 €	22103315252	135,00 €	221034002	300,00 €
EPDM	4	221172509	15,00 €	221172509	15,00 €	221173159	20,00 €	221174009	40,00 €
FPM	5	221152509	16,50 €	221152509	22,50 €	221153159	42,00 €	221154009	54,00 €
EPDM	5	221152501	66,00 €	221152501	90,00 €	221153151	168,00 €	221154001	216,00 €
FPM	6	221122502	1,00 €	221122502	1,00 €	221122502	2,00 €	221122502	5,00 €



**U-PVC Yaylı Çekvalfler Yedek Parça Listesi**  
*U-PVC True Union Spring Checkvalve Spare Parts List*

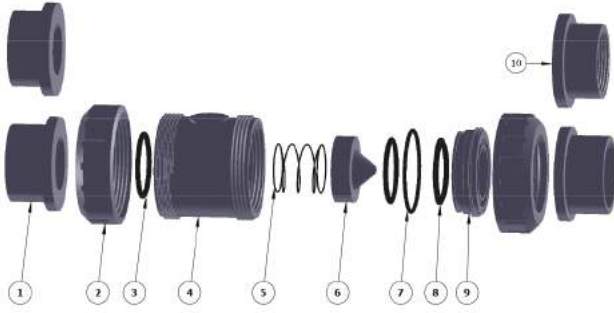

No	Parça Part	Malzeme Material	Adet QTY
1	Kole	U-PVC	2
2	Somun / Unicon Nut	U-PVC	2
3	Gövde O-Ring	EPDM	2
4	Gövde / Body	U-PVC	1
5	Yay / Sprino	Stainless Stell 316	1
6	Klape / Valve	U-PVC	1
7	Dayama O-Ring	EPDM	1
8	Klape O-Ringi / Valve O-Ring	EPDM	1
9	Küre Dayama / Union Bush	U-PVC	1
10	İç Dişli Kole	U-PVC	2

No	Ø20 Kod /Code	Fiyat (Adet) Price (Pcs)	Ø25 Kod /Code	Fiyat (Adet) Price (Pcs)	Ø32 Kod /Code	Fiyat (Adet) Price (Pcs)	Ø40 Kod /Code	Fiyat (Adet) Price (Pcs)	Ø50 Kod /Code	Fiyat (Adet) Price (Pcs)
1	512000202	0,55 €	512000252	0,55 €	512000322	0,70 €	512000402	0,79 €	512000202	0,79 €
2	202010202	1,10 €	202010252	1,30 €	202010322	1,60 €	202010402	1,80 €	202010202	2,50 €
3	202030209	0,50 €	202030259	0,60 €	202100909	0,70 €	202030409	0,70 €	202030209	0,90 €
4	214040202	1,80 €	214040252	2,90 €	214040322	3,80 €	214040402	5,20 €	214040202	7,80 €
5	214050209	1,95 €	214050259	2,15 €	214040329	2,50 €	214050409	2,90 €	214050209	3,10 €
6	214060202	1,10 €	214060252	1,30 €	214060322	1,40 €	214060402	2,20 €	214060202	3,60 €
7	202120209	0,40 €	202120259	0,50 €	202120329	0,70 €	202120409	0,70 €	202120209	0,85 €
8	202070209	0,20 €	202070259	0,20 €	202070329	0,40 €	202120259	0,50 €	202070209	0,70 €
9	202130202	0,80 €	202130252	1,00 €	202130322	1,60 €	202130402	1,75 €	202130202	1,95 €
10	512020202	0,95 €	512020252	1,15 €	512020322	1,35 €	512020402	1,55 €	512020202	2,00 €

No	Ø63 Kod /Code	Fiyat (Adet) Price (Pcs)	Ø75 Kod /Code	Fiyat (Adet) Price (Pcs)	Ø90 Kod /Code	Fiyat (Adet) Price (Pcs)	Ø110 Kod /Code	Fiyat (Adet) Price (Pcs)
1	512000252	0,81 €	512000322	1,00 €	512000402	1,30 €	512001102	1,75 €
2	202010252	3,30 €	202010322	6,60 €	202010402	9,00 €	202011102	11,00 €
3	202030259	4,30 €	202100909	2,20 €	202030409	2,90 €	202031109	5,00 €
4	214040252	9,30 €	214040322	11,50 €	214040402	14,90 €	214041102	19,75 €
5	214050259	3,75 €	214040329	5,25 €	214050409	6,50 €	214051109	7,80 €
6	214060252	5,50 €	214060322	9,50 €	214060402	11,30 €	214061102	14,75 €
7	202120259	2,80 €	202120329	3,00 €	202120409	3,50 €	202121109	5,60 €
8	202070259	0,70 €	202070329	1,30 €	202120259	1,70 €	202071109	2,20 €
9	202130252	2,10 €	202130322	3,80 €	202130402	4,90 €	202131102	6,50 €
10	512020252	2,25 €	512020322	3,95 €	512020402	4,35 €	512021102	5,00 €



## PP Rakor Yedek Parça Listesi

### PP Union Spare Parts List

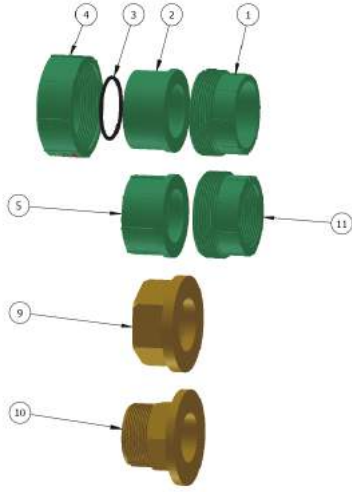

No	Parça Part	Malzeme Material	Adet QTY
1	Rakor Gövde	PP	1
2	Adaptör	PP	1
3	Gövde O-Ring / Body O-Ring	EPDM / FPM	1
4	Somun / Nut	PP	1
5	İç Diş Adaptör	PP	1
9	İç Diş Adaptör	BRASS	1
10	Dış Diş Adaptör	BRASS	1
11	İç Dişli Rakor Gövde	PP	1

No	Ø20 Kod /Code	Fiyat (Adet) Price (Pcs)	Ø25 Kod /Code	Fiyat (Adet) Price (Pcs)	Ø32 Kod /Code	Fiyat (Adet) Price (Pcs)	Ø40 Kod /Code	Fiyat (Adet) Price (Pcs)	Ø50 Kod /Code	Fiyat (Adet) Price (Pcs)	
1	406050202	1,10 €	406050252	2,70 €	406050322	2,70 €	406050402	2,90 €	406050502	3,70 €	
2	512030202	0,66 €	512030252	0,66 €	512030322	0,84 €	512030402	0,95 €	406010502	0,95 €	
EPDM	3	202030209	0,50 €	202030259	0,60 €	202100909	0,70 €	202030409	0,70 €	202030509	0,90 €
FPM	3	2050302096	1,80 €	205030259	1,90 €	205100909	2,00 €	205030409	2,00 €	205030509	2,90 €
4	400010202	1,20 €	400010252	1,50 €	400010322	1,90 €	400010402	2,10 €	406020502	2,50 €	
5	512240202	1,14 €	512240252	1,38 €	512240322	1,62 €	512240402	1,86 €	512240502	2,40 €	
9	202180202	2,55 €	202180252	4,10 €	202180322	5,20 €	202180402	8,00 €	202180502	14,50 €	
10	202170202	3,50 €	202170252	4,90 €	202170322	6,30 €	202170402	9,90 €	202170502	15,55 €	
11	408050202	1,40 €	408050252	2,20 €	408050322	2,90 €	408050402	3,10 €	408050502	3,90 €	

No	Ø63 Kod /Code	Fiyat (Adet) Price (Pcs)	Ø75 Kod /Code	Fiyat (Adet) Price (Pcs)	Ø90 Kod /Code	Fiyat (Adet) Price (Pcs)	Ø110 Kod /Code	Fiyat (Adet) Price (Pcs)	
1	406050632	4,35 €	406050752	9,70 €	406050902	13,85 €	406051102	16,60 €	
2	406010632	0,97 €	512030752	1,20 €	512030902	1,56 €	512031102	2,48 €	
EPDM	3	202030639	1,30 €	202030759	2,20 €	202030909	2,90 €	202031109	5,00 €
FPM	3	205030639	3,10 €	205030759	3,80 €	205030909	4,20 €	406031109	6,50 €
4	406020632	3,30 €	400010752	7,50 €	406020902	11,50 €	400010902	14,30 €	
5	512240632	2,70 €	512240752	4,74 €	512240902	5,22 €	512241102	6,00 €	
9	202180632	28,75 €							
10	202170632	34,55 €							
11	408050632	4,95 €	408050752	11,00 €	408050902	14,30 €	408051102	17,20 €	



**PP Küresel Vana Yedek Parça Listesi**  
PP True Union Ball Valves Spare Parts List

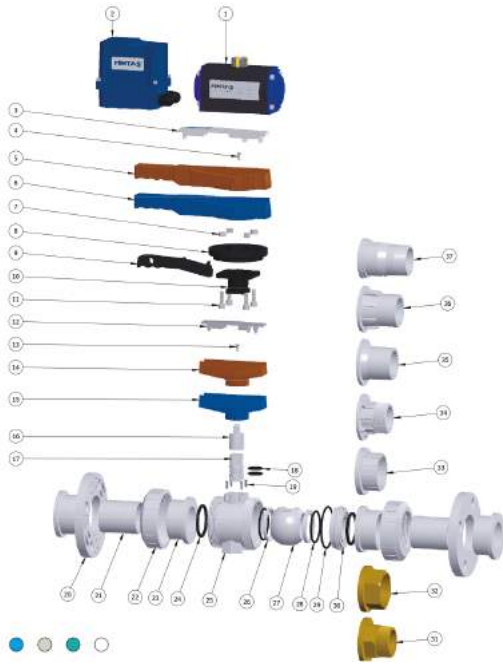

No	Parça Part	Malzeme Material	Adet QTY
1	Pnomatik Aktuatör		1
2	Elektrikli Aktuatör		1
3	Kol Kapağı / Handle Cover	PVC	1
4	Civata / Screw	INOX	1
5	Kol / Handle (ASİT VANA KOL)	ABS	1
6	Kol / Handle (SU VANA KOL)	ABS	1
7	Somun / Nut	INOX	4
8	Çark / Index Plate	PP GF	1
9	Mandal / Lever Catch	PP GF	1
10	Adaptör Ara Parça	PP	1
11	ISO 4762 M8 x 25 --- 25S	INOX	4
12	Kol Kapağı / Handle Cover	ABS	1
13	Civata / Screw	INOX	1
14	Kol / Handle (ASİT)	ABS	1
15	Kol / Handle (SU)	ABS	1
16	Pim Uzatma Parçası	PP	1
17	Pim / Step	PP	1
18	Pim O-Ringi / Step O-Ring	EPDM / FPM	2
19	Vida / Screw	INOX	4

No	Ø20 Kod /Code	Fiyat (Adet) Price (Pcs)	Ø25 Kod /Code	Fiyat (Adet) Price (Pcs)	Ø32 Kod /Code	Fiyat (Adet) Price (Pcs)	Ø40 Kod /Code	Fiyat (Adet) Price (Pcs)	Ø50 Kod /Code	Fiyat (Adet) Price (Pcs)	
1	700002026	202,40 €	700002526	202,40 €	700003226	202,40 €	700004026	212,10 €	700006326	240,10 €	
2	700002027	225,10 €	700002527	225,10 €	700003227	225,10 €	700004027	245,20 €	700005027	245,20 €	
3											
4											
5											
6											
7											
8											
9											
10	201600202	2,00 €	201600202	2,00 €	201600322	3,00 €	201600322	3,00 €	201600502	3,50 €	
11	K00201479	1,50 €	K00201479	1,50 €	K00201479	1,50 €	K00201479	1,50 €	K00201479	1,50 €	
12	202050202	0,50 €	202050202	0,50 €	202050322	0,73 €	202050402	0,82 €	202050502	0,86 €	
13	100304199	0,50 €	100304199	0,50 €	100304199	0,50 €	100304199	0,50 €	100304199	0,50 €	
14	205040202	1,10 €	205040202	1,10 €	205040322	1,60 €	205040402	1,80 €	205040502	1,90 €	
15	202040202	1,10 €	202040202	1,10 €	202040322	1,60 €	202040402	1,80 €	202040502	1,90 €	
16	202090251	1,50 €	202090251	1,50 €	202090321	1,60 €	202090321	1,60 €	202090501	1,90 €	
17	400090202	0,90 €	400090202	0,90 €	400090322	1,00 €	400090322	1,00 €	400090502	1,25 €	
18	202100209	0,10 €	202100209	0,10 €	202100329	0,20 €	202100329	0,20 €	202100509	0,30 €	
EPDM	18	205100209	0,90 €	205100209	0,90 €	205100329	1,10 €	205100329	1,20 €	205100509	1,30 €
FPM	18										
19											
20	513010202	1,38 €	513010252	1,38 €	513010322	1,56 €	513010402	1,80 €	513010502	1,80 €	
21	201310202	1,80 €	201310252	1,80 €	201310322	2,20 €	201310402	2,40 €	201310502	2,60 €	
22	400010202	1,20 €	400010252	1,50 €	400010322	1,90 €	400010402	2,10 €	400010502	3,00 €	
23	512030202	0,66 €	512030252	0,66 €	512030322	0,84 €	512030402	0,95 €	512030502	0,95 €	
EPDM	24	202030209	0,50 €	202030259	0,60 €	202100909	0,70 €	202030409	0,70 €	202030509	0,90 €
FPM	24	205030209	1,20 €	205030259	1,30 €	202100909	1,40 €	205030409	1,40 €	205030509	1,90 €
25	400060202	2,20 €	400060252	2,36 €	400060322	3,30 €	400060402	4,40 €	400060502	8,55 €	
26	205080202	2,50 €	205080259	3,50 €	205080329	5,50 €	205080409	7,00 €	205080509	9,00 €	
27	400110202	1,20 €	400110252	1,30 €	400110322	1,70 €	400110402	2,70 €	400110502	4,15 €	
EPDM	28	202070209	1,30 €	202070259	1,20 €	202070329	1,40 €	202120259	1,30 €	202070509	1,70 €
FPM	28	205070209	2,10 €	205070259	2,30 €	205070329	2,60 €	205120259	2,60 €	205070509	2,70 €
EPDM	29	202120209	0,40 €	202120259	0,50 €	202120329	0,70 €	202120409	0,70 €	202070639	0,85 €
FPM	29	205120209	1,10 €	205120259	1,20 €	205120329	1,30 €	205120409	1,30 €	205070639	1,85 €
30	400130202	1,00 €	400130252	1,20 €	400130322	1,90 €	400130402	1,95 €	400130502	2,15 €	
31	202170202	3,05 €	202170252	5,90 €	202170322	7,80 €	202170402	11,40 €	202170502	17,50 €	
32	202180202	2,55 €	202180252	4,90 €	202180322	6,30 €	202180402	9,90 €	202180502	15,55 €	
33	512040202	1,14 €	512040252	1,38 €	512040322	1,62 €	512040402	1,86 €	512040502	2,40 €	
34	229100202		229100252		229100322		229100402		229100502		
35	758160209		758160259		758160329		758160409		758160509		
36	512310202		512310252		512310322		512310402		512310502		
37	512610202		512610252		512610322		512610402		512610502		



No	Parça Part	Malzeme Material	Adet QTY
20	Flanş / Flange	PP	2
21	Kole Ara Parça	PP	2
22	Somun / Union Nut	PP	2
23	Adaptör	PP	4
24	Gövde O-Ringi / Body O-Ring	EPDM / FPM	2
25	Gövde / Body	PP	1
26	Conta / Gasket	TEFLON	2
27	Küre / Ball	PP	1
28	Conta Altı O-Ring / Backing Seals	EPDM / FPM	2
29	Dayama O-Ring	EPDM / FPM	1
30	Küre Dayama / Union Bush	PP	1
31	Dış Dış Adaptör	BRASS	1
32	İç Dış Adaptör	BRASS	1
33	İç Dişli Adaptör	PP	1
34	Dış Dişli Adaptör	PP	1
35	Adaptör	HDPE	1
36	Dış Yapıştırma Adaptör	PP	1
37	Hortum Adaptörü	PP	1

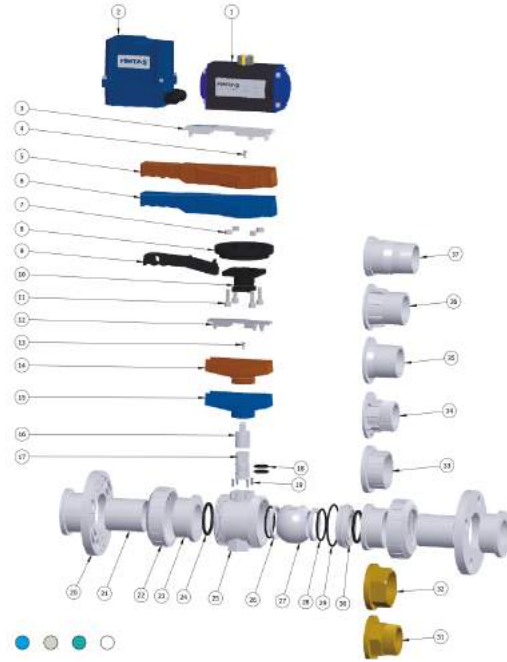

No	Ø63 Kod /Code	Fiyat (Adet) Price (Pcs)	Ø75 Kod /Code	Fiyat (Adet) Price (Pcs)	Ø90 Kod /Code	Fiyat (Adet) Price (Pcs)	Ø110 Kod /Code	Fiyat (Adet) Price (Pcs)
1	700006326	244,40 €	700007526	306,14 €	700009026	326,72 €	700011026	372,41 €
2	700006327	286,14 €	700007527	315,00 €	700009027	343,24 €	700011027	361,50 €
3	2022050632	0,90 €	2022050752	0,90 €	2022050902	0,90 €	2022051102	0,90 €
4	202501499	2,10 €	202501499	2,10 €	202501499	2,10 €	202501499	2,10 €
5	291130905	13,00 €	291130905	13,00 €	291130905	13,00 €	291131105	15,00 €
6	291139904	13,00 €	291139904	13,00 €	291139904	13,00 €	291131104	15,00 €
7	201151969	0,80 €	201151969	0,80 €	201151969	0,80 €	201151969	0,80 €
8	400267952	6,80 €	400267952	6,80 €	400267952	6,80 €	400267952	6,80 €
9	400267962	6,00 €	400267962	6,00 €	400267962	6,00 €	400267962	6,00 €
10	201600752	4,50 €	201600752	4,50 €	201600902	5,00 €	201600902	5,00 €
11	K00201479	4,50 €	K00201479	1,50 €	K00201479	1,50 €	K00201479	1,50 €
12	202050632	0,95 €	202050752	1,73 €	202050902	2,27 €	202051102	3,41 €
13	I00300749	0,80 €	I00300749	0,80 €	I00300749	0,80 €	I00300749	0,80 €
14	205040632	2,10 €	205040752	3,80 €	205040902	5,00 €	205041102	7,50 €
15	202040632	2,10 €	202040752	3,80 €	202040902	5,00 €	202041102	7,50 €
16	202090631	2,10 €	202090631	3,80 €	202090901	5,00 €	202090901	7,50 €
17	400090632	1,55 €	400090632	1,55 €	400090902	3,00 €	400090902	3,00 €
18	202100639	0,50 €	202100639	0,50 €	202100909	0,70 €	202100909	0,70 €
18	205100639	1,50 €	205100639	1,50 €	205100909	1,70 €	205100909	1,70 €
19	201150639	0,50 €	201150759	0,50 €	201150759	0,70 €	201150909	0,70 €
20	513010632	1,98 €	513010752	2,58 €	513010902	2,88 €	513011102	3,06 €
21	201310632	3,80 €	201310752	3,80 €	201310902	4,20 €	201311102	4,60 €
22	400010632	3,70 €	400010752	7,50 €	400010902	11,50 €	40011102	14,30 €
23	512030632	0,97 €	512030752	4,20 €	512030902	1,56 €	512031102	2,48 €
24	202030639	1,30 €	202030759	2,20 €	202030909	2,90 €	202031109	5,00 €
24	202030639	2,30 €	205030759	3,20 €	205030909	3,90 €	205031109	6,00 €
25	400060632	8,45 €	400060752	28,00 €	400060902	32,00 €	400061102	42,00 €
26	205080639	11,00 €	205080759	14,00 €	205080909	18,00 €	205081109	24,00 €
27	400110632	6,15 €	400110752	13,30 €	400110902	19,30 €	400111102	24,00 €
28	202070639	1,70 €	202070759	2,10 €	202070909	2,30 €	202071109	3,10 €
28	205070639	2,70 €	205070759	3,10 €	205070909	3,30 €	205071109	4,10 €
29	202120639	0,90 €	202030909	3,00 €	202120909	3,90 €	202121109	5,60 €
29	205120639	1,90 €	205030909	4,00 €	205120909	4,90 €	205121109	6,60 €
30	400130632	2,35 €	400130752	4,25 €	400130902	5,35 €	400131102	8,20 €
31	202170632	40,05 €						
32	202180632	34,55 €						
33	512040632	2,70 €	512040752	4,74 €	512040902	5,22 €	512041102	6,00 €
34	229100632		229100752		229100902		229101102	
35	758160639		753800012		758160909		758161109	
36	512310632		512310752		512310902		512311102	
37	512610632		512610752		512610902		512611102	



**PP Yaylı Çekvalfler Yedek Parça Listesi**  
*PP True Union Spring Checkvalve Spare Parts List*

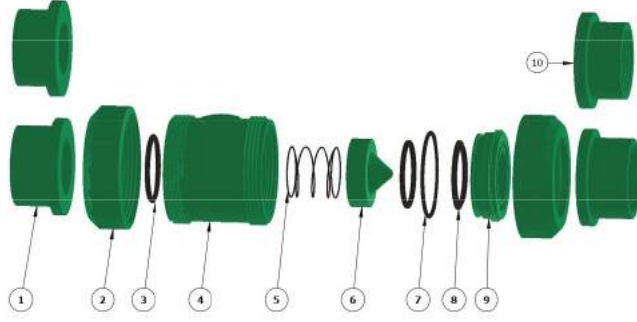

No	Parça Part	Malzeme Material	Adet QTY
1	Somun / Union Nut	PPRC	2
2	Bağl. Parçası / End Connector	PPRC	2
3	Bağl. Parçası / End Connector Thr.	PPRC	2
4	Gövde O-Ringi / Body O-Ring	EPDM	2
5	Gövde / Body	PPRC	1
6	Yay / Spring	INOX	1
7	Subap / Subap	PPRC	1
8	Subap O-Ringi / Carrier O-Ring	EPDM	1
9	Subap Dayama / Valve Bush	PPRC	1
10	Sıkıştırma O-Ringi / Carrier O-Ring	EPDM	1

No	Ø20 Kod /Code	Fiyat (Adet) Price (Pcs)	Ø25 Kod /Code	Fiyat (Adet) Price (Pcs)	Ø32 Kod /Code	Fiyat (Adet) Price (Pcs)	Ø40 Kod /Code	Fiyat (Adet) Price (Pcs)	Ø50 Kod /Code	Fiyat (Adet) Price (Pcs)
1	400010202	1,20 €	400010252	1,50 €	400010322	1,90 €	400010402	2,10 €	400010502	3,00 €
2	512030202	0,66 €	512030252	0,66 €	512030322	0,84 €	512030402	0,95 €	512030502	0,95 €
3	512040202	1,14 €	512040252	1,38 €	512040322	1,62 €	512040402	1,86 €	512040502	2,40 €
4	202030209	0,50 €	202030259	0,60 €	202100909	0,70 €	202030409	0,70 €	202030509	0,90 €
5	403040202	2,55 €	403040252	3,85 €	403040322	4,85 €	403040402	6,90 €	403040502	11,00 €
6	214050209	1,95 €	214050259	2,15 €	214050329	2,50 €	214050409	2,90 €	214050509	3,10 €
7	403060202	1,50 €	403060252	1,80 €	403060322	2,00 €	403060402	2,50 €	403060502	4,00 €
8	202070209	1,13 €	202070259	0,20 €	202070329	0,40 €	202070409	0,50 €	202070509	0,70 €
9	400130202	1,00 €	400130252	1,20 €	400130322	1,90 €	400130402	1,95 €	400130502	2,15 €
10	202120209	0,40 €	212120259	0,50 €	202120329	0,70 €	202120409	0,70 €	202070639	0,85 €

No	Ø63 Kod /Code	Fiyat (Adet) Price (Pcs)	Ø75 Kod /Code	Fiyat (Adet) Price (Pcs)	Ø90 Kod /Code	Fiyat (Adet) Price (Pcs)	Ø110 Kod /Code	Fiyat (Adet) Price (Pcs)
1	400010632	3,70 €	400010752	7,50 €	400010902	11,50 €	400011102	14,30 €
2	512030632	0,97 €	512030752	1,20 €	512030902	1,56 €	512031102	2,48 €
3	512040632	2,70 €	512040752	4,74 €	512040902	5,22 €	512041102	6,00 €
4	202030639	1,30 €	202030759	2,20 €	202030909	2,90 €	202031109	5,00 €
5	403040632	12,50 €	403040752	29,00 €	403040902	39,00 €	403041102	50,00 €
6	214050639	3,75 €	214050759	5,25 €	214050909	6,50 €	221171109	7,80 €
7	403060632	6,00 €	403060752	11,00 €	403060902	13,00 €	403061102	17,00 €
8	202070639	0,70 €	202070759	13,00 €	202070909	1,70 €	202071109	2,20 €
9	400130632	2,35 €	400130752	4,25 €	400130902	5,35 €	400131102	8,20 €
10	202120639	1,25 €	202030909	3,00 €	202120909	3,90 €	202121109	5,60 €





## Tek Taraflı Tek Taraf Dişli Vana

### Single Union One Side Threaded Ball Valve

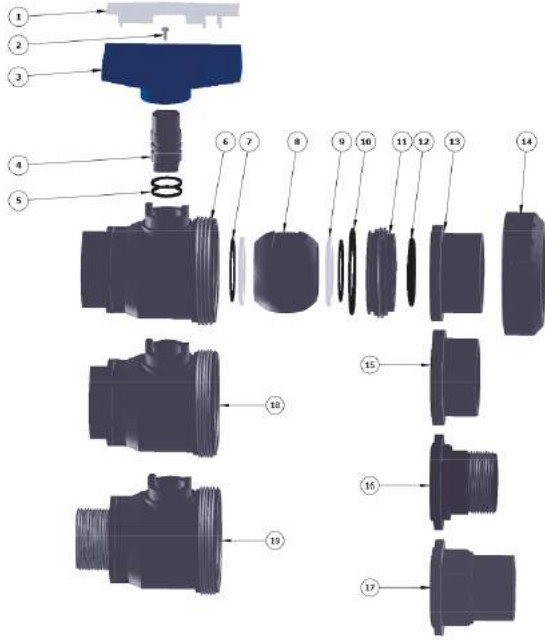

No	Parça Part	Malzeme Material	Adet QTY
1	Kol Kapağı / Handle Cover	U-PVC	1
2	Civata / Screw	INOX	1
3	Kol / Handle	ABS	1
4	Pim / Step	U-PVC	1
5	Pim O-Ring / Step O-Ring	EPDM	2
6	Gövde / Body	U-PVC	1
7	Conta Altı O-Ring / Backing Seals	EPDM	2
8	Küre / Ball	U-PVC	1
9	Küre Contası / Ball Gasket	HDPE	2
10	Dayama O-Ring	EPDM	1
11	Küre Dayama / Union Bush	U-PVC	1
12	Gövde O-Ring / Body O-Ring	EPDM	1
13	Adaptör	U-PVC	1
14	Somun / Union Nut	U-PVC	1
15	İç Dişli Adaptör	U-PVC	1
16	Dıştan Dişli Adaptör	U-PVC	1
17	İç Diş Yapıştırma Adaptör	U-PVC	1
18	İç Diş Gövde / Body	U-PVC	1
19	Dış Diş Gövde / Body	U-PVC	1

No	Ø20 Kod /Code	Fiyat (Adet) Price (Pcs)	Ø25 Kod /Code	Fiyat (Adet) Price (Pcs)	Ø32 Kod /Code	Fiyat (Adet) Price (Pcs)	Ø40 Kod /Code	Fiyat (Adet) Price (Pcs)	Ø50 Kod /Code	Fiyat (Adet) Price (Pcs)
1	202050202	0,50 €	202050202	0,50 €	202050322	0,70 €	202050402	0,80 €	202050502	0,80 €
2	100304199	1,10 €	100304199	1,10 €	100304199	1,60 €	100304199	1,80 €	202150329	1,90 €
3	202040202	1,10 €	202040202	1,10 €	202040322	1,60 €	202040402	1,80 €	202040502	1,90 €
4	202090202	0,70 €	202090202	0,70 €	202090322	0,80 €	202090322	0,80 €	202090502	1,00 €
5	202100209	0,10 €	202100209	0,10 €	202100329	0,20 €	202100329	0,20 €	202100509	0,30 €
6	232060202	1,80 €	232060252	2,10 €	232060322	2,90 €	232060402	3,80 €	232060502	7,00 €
7	202070209	0,20 €	202070259	0,20 €	202070329	0,40 €	202120259	0,50 €	202070509	0,70 €
8	202110202	1,00 €	202110252	1,10 €	202110322	1,40 €	202110402	2,20 €	202110502	3,50 €
9	202080202	0,30 €	202080252	0,40 €	202080322	0,50 €	202080402	0,60 €	202080502	0,70 €
10	202120209	0,40 €	202120259	0,50 €	202120329	0,70 €	202120409	0,70 €	202070639	0,85 €
11	202130202	0,80 €	202130252	1,00 €	202130322	1,60 €	202130402	1,75 €	202130502	1,95 €
12	202030209	0,50 €	202030259	0,60 €	202100909	0,70 €	202030409	0,70 €	202030509	0,90 €
13	512000202	0,55 €	512000252	0,55 €	512000322	0,70 €	512000402	0,79 €	512000502	0,79 €
14	202010202	1,10 €	202010252	1,30 €	202010322	1,60 €	202010402	1,80 €	202010502	2,50 €
15	512020202	0,95 €	512020252	1,11 €	512020322	1,35 €	512020402	1,55 €	512020502	2,00 €
16	229060202		229060252		229060322		229060402		229060502	
17	512110202		512110252		512110322		512110402		512110502	
18	232260202	1,80 €	232260252	2,10 €	232260322	2,90 €	232260402	3,80 €	232260502	7,00 €
19	232660202	1,80 €	232660252	2,10 €	232660322	2,90 €	2326604032	3,80 €	232660502	7,00 €

No	Ø63 Kod /Code	Fiyat (Adet) Price (Pcs)	Ø75 Kod /Code	Fiyat (Adet) Price (Pcs)	Ø90 Kod /Code	Fiyat (Adet) Price (Pcs)	Ø110 Kod /Code	Fiyat (Adet) Price (Pcs)
1	202050632	0,80 €	202050752	0,90 €	202050902	1,10 €	202051102	2,10 €
2	202150329	2,10 €	202150329	3,80 €	202150329	5,00 €	202150329	7,50 €
3	202040632	2,10 €	202040752	3,80 €	202040902	5,00 €	202041102	7,50 €
4	202090632	1,30 €	202090632	1,30 €	202090902	2,50 €	202090902	2,50 €
5	202100639	0,50 €	202100639	0,50 €	202100909	0,70 €	202100909	0,70 €
6	232060632	15,00 €	232060752	20,00 €	232060902	25,00 €	232061102	35,00 €
7	202070639	0,70 €	202070759	1,30 €	202070909	1,70 €	202071109	2,20 €
8	202110632	5,20 €	202110752	11,50 €	202110902	15,00 €	202111102	20,00 €
9	202080632	0,70 €	202080752	1,00 €	202080902	1,20 €	202081102	1,40 €
10	202120639	2,80 €	202030909	3,00 €	202120909	3,90 €	202121109	5,60 €
11	202130632	2,10 €	202130752	3,80 €	202130902	4,90 €	202131102	6,50 €
12	202030639	1,30 €	202030759	2,20 €	202030909	2,90 €	202031109	5,00 €
13	512000632	0,81 €	512000752	1,00 €	512000902	1,30 €	512001102	1,75 €
14	202010632	3,30 €	202010752	6,60 €	202010902	9,00 €	202011102	11,00 €
15	512020632	2,25 €	512020752	3,95 €	512020902	4,35 €	512021102	5,00 €
16	229060632		229060752		229060902		229061102	
17	512110632		512110752		512110902		512111102	
18	232260632	15,00 €	232260752	20,00 €	232260902	25,00 €	232261102	35,00 €
19	232660632	15,00 €	232660752	20,00 €	232660902	25,00 €	232661102	35,00 €





*Where you are,  
pintas is there...*

*since 1977*



# PIMTAS®

PLASTİK İNŞ. MALZ.SAN. VE TİC. A.Ş.

Gebze Plastikçiler Organize San. Böl. Cumhuriyet Cad. No:52 Gebze/ KOCAELİ

T: +90 262 751 24 24 F:+90 262 751 42 04

[www.pimtas.com](http://www.pimtas.com) / [www.pimtasshop.com](http://www.pimtasshop.com)